

Nr	Ausmaß	St	Colli
1	1100 700	30	1 1-1
2	380 79	79	2 1-1
3	380 79	79	2 1-1
4	100 100	15	4 1-1
5	1018 618	15	1 1-1

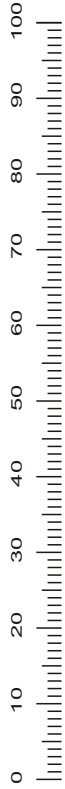

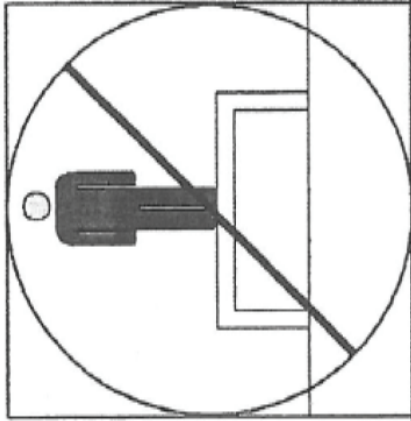

## 1

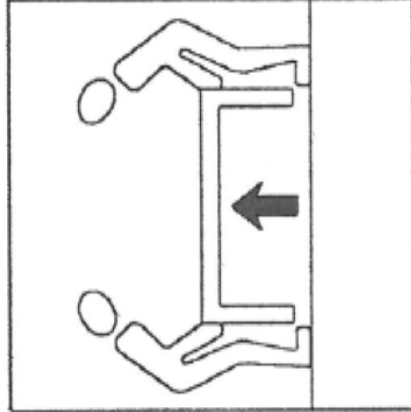
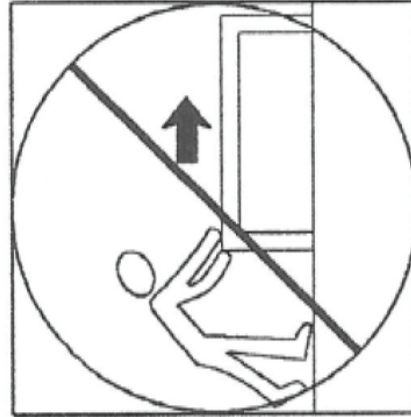
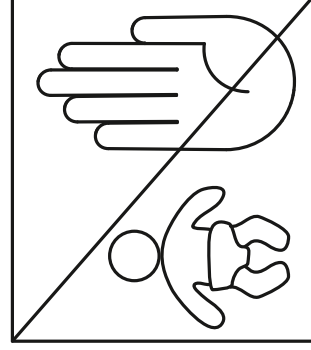
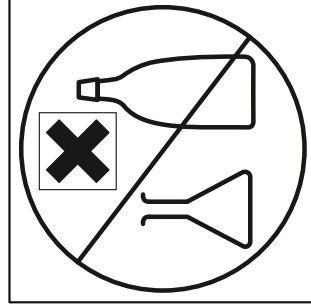
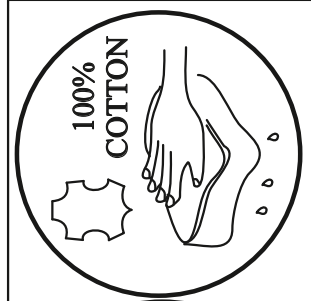
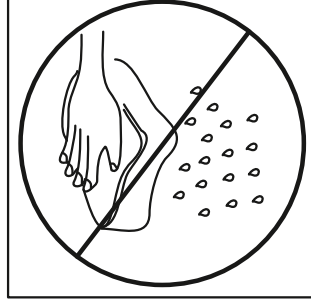
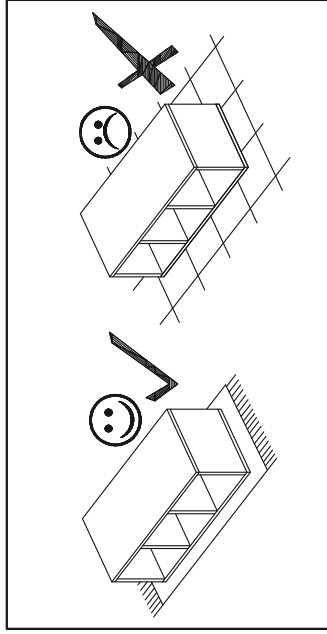
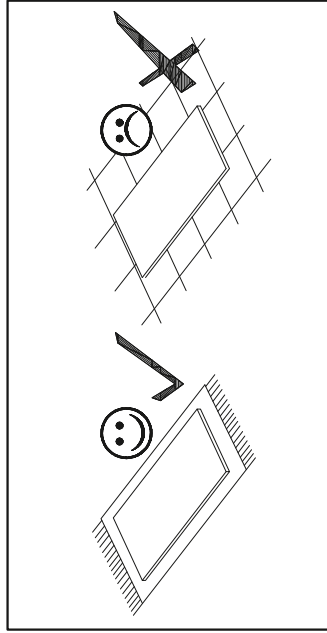
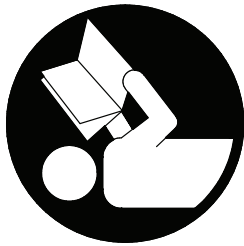
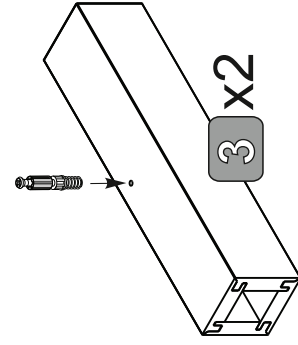
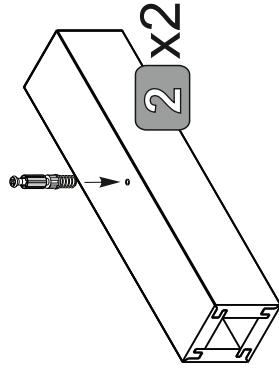
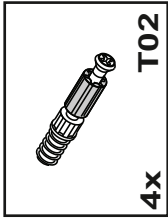
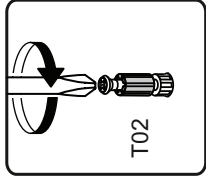

## 2 (x2)

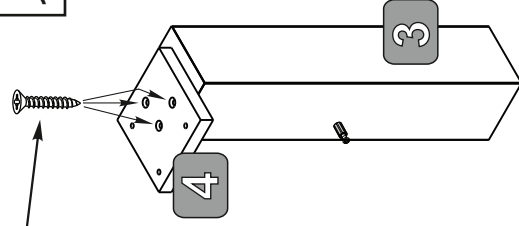
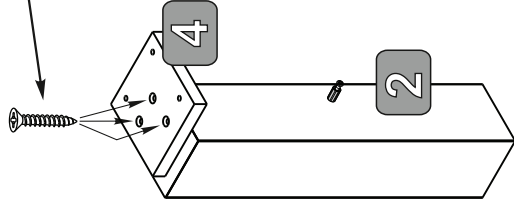
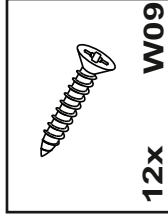
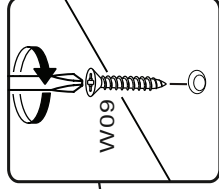

## 3

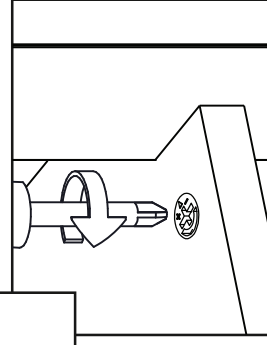
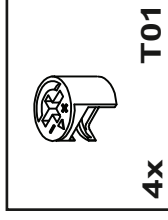
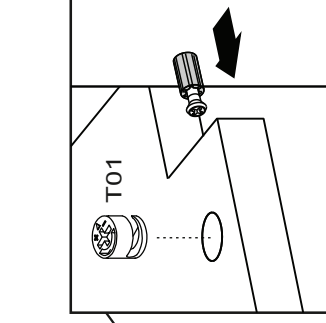
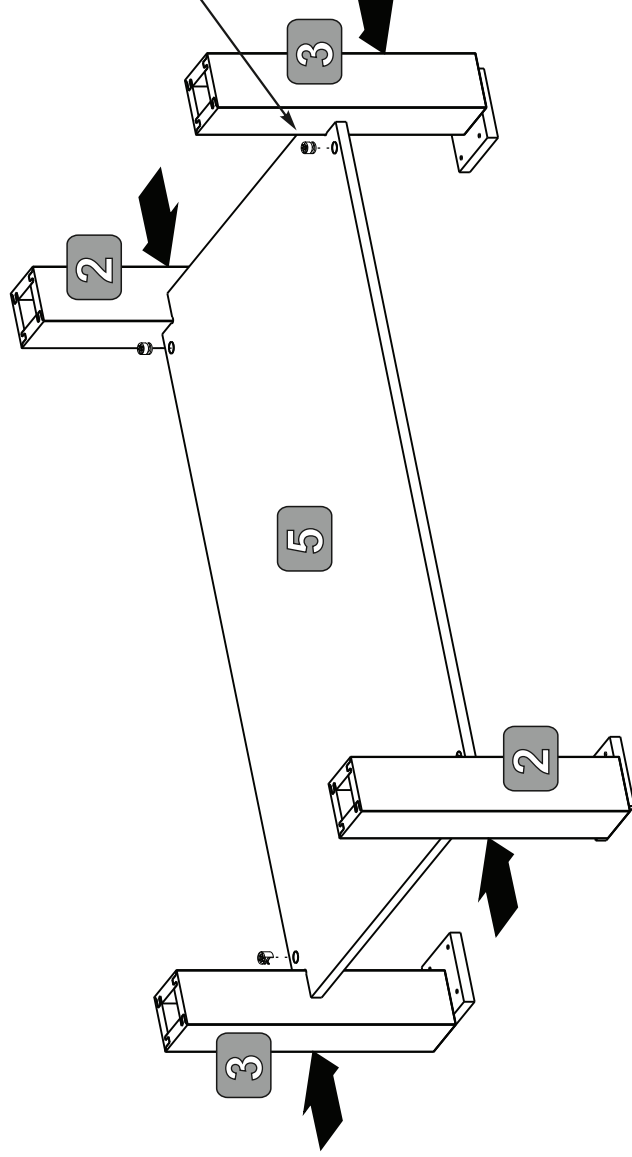

4

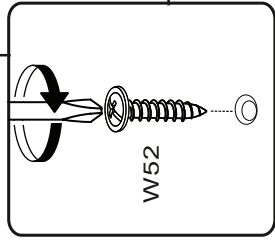
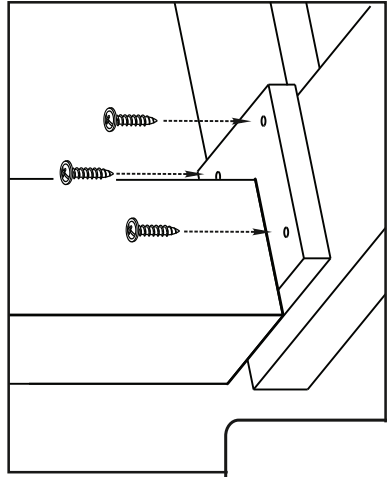

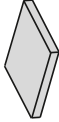
	<b>W52</b>	<b>12x</b>
	<b>12x</b>	<b>S09</b>

