

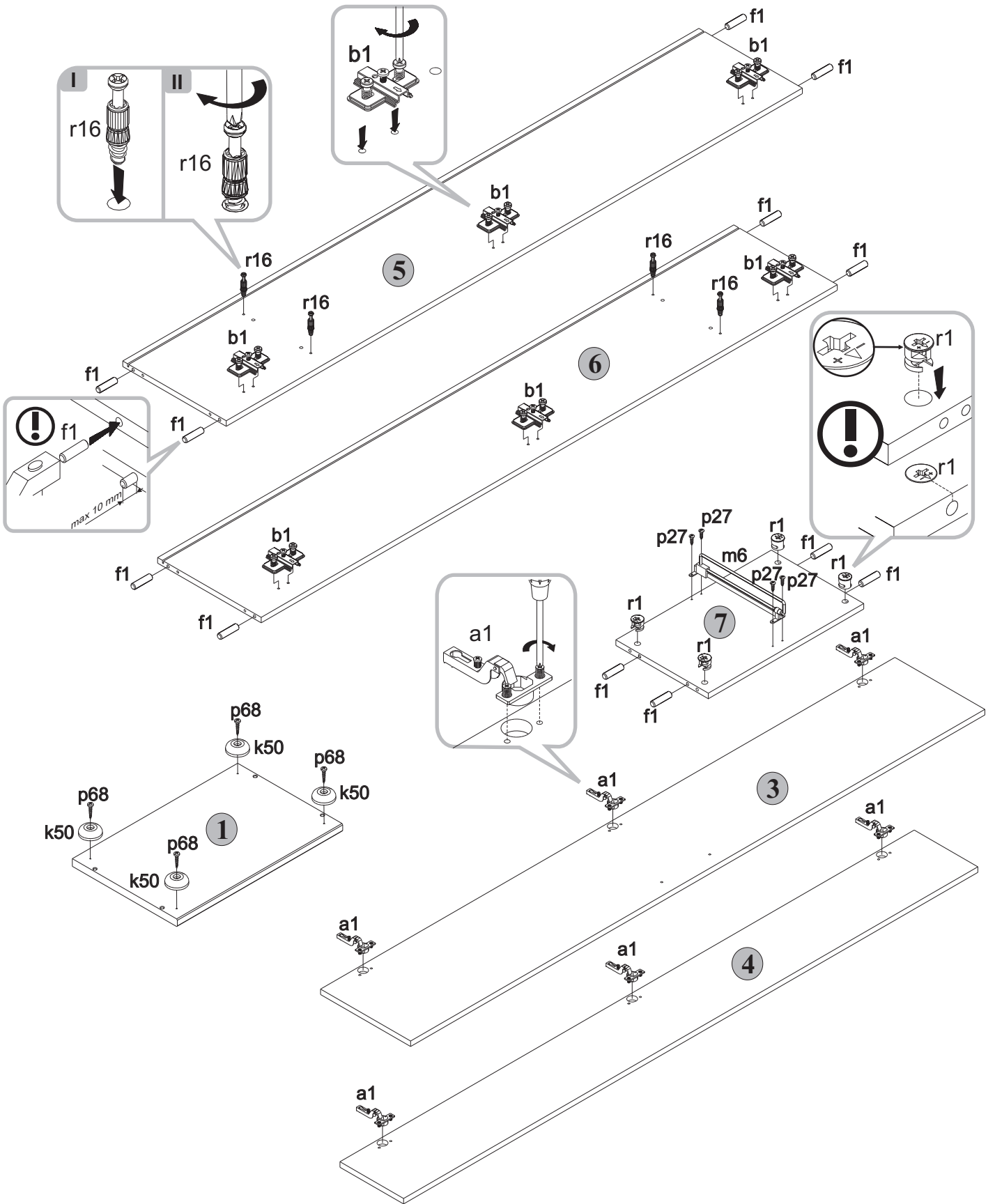









A	B	C	D
1	S 19-258	551x350	3/5
2	S 19-259	551x350	3/5
3	S 19-089	1914x300	3/5
4	S 19-058	1914x212	3/5
5	S 19-1155	1920x345	3/5
6	S 19-1156	1920x345	3/5
7	S 19-3306	518x308	3/5
8	S 19-983	1934x531	3/5

1x 128 mm <b>c289</b>	2x φ4x30 mm <b>p9</b>	12x φ8x30 mm <b>f1</b>	8x φ7x50 mm <b>e1</b>	4x φ16 <b>s2</b>	
6x <b>b1</b>	6x K16 <b>a1</b>	4x φ15x12mm #16 <b>r1</b>	4x <b>r16</b>	4x φ3,5x13 mm <b>p27</b>	
4x <b>k50</b>	1x L-300 <b>m6</b>	5x <b>l1</b>	4x φ4x20 mm <b>p68</b>	1x <b>z1</b>	

# 1



6x  <b>b1</b>	6x  <b>a1</b>	4x  <b>k50</b>	1x  <b>L-300 m6</b>	4x  <b>p27</b>	12x  <b>f1</b>	4x  <b>r1</b>	4x  <b>r16</b>	4x  <b>p68</b>
--	--	---	--	---	--	--	---	---

# 2

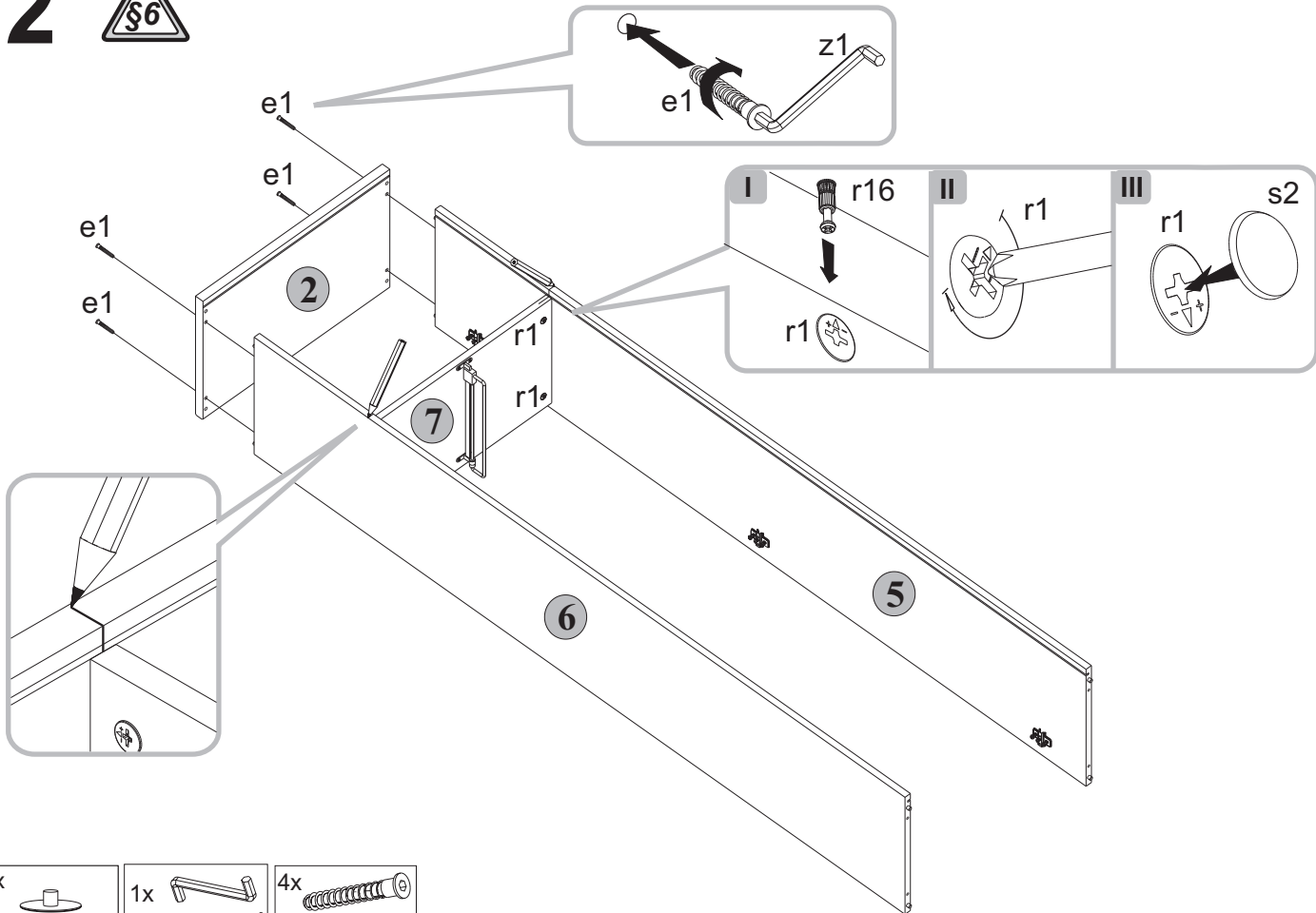

# 3

