

B - 1500mm
 H - 220mm
 T - 215mm

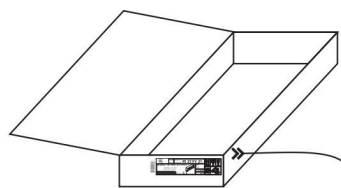

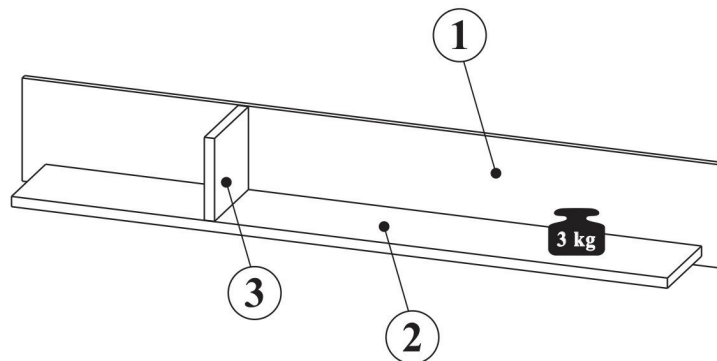
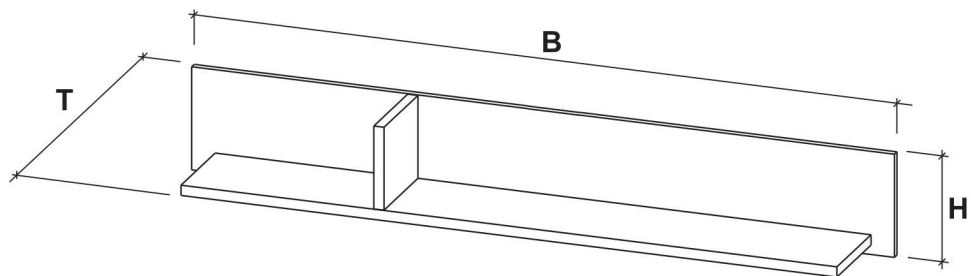

1	1500	220	1	1
2	1400	200	1	1
3	180	177	1	1

- NR 1**
- (K2)** 7x70 x9
 - (K1)** 7x50 x2
 - (F50)** x3
 - (E2)** 5x11 x6
 - (T10)** x3
 - (T13)** 10x50 mm x3
 - (S25)** 4x70 x1
 - (S26)** 8x50 mm x1
 - (K3)** x1



- NR 2**
- (C14)** x1
 - (C18)** x3

1

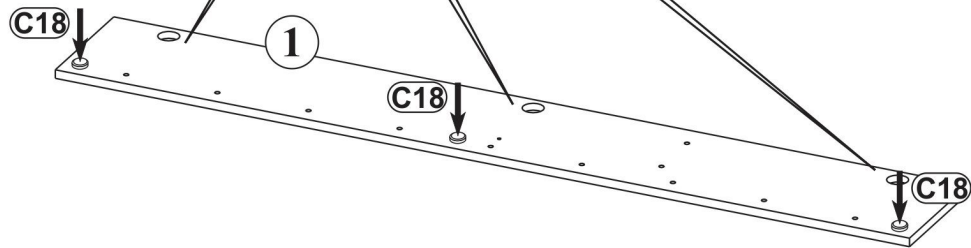
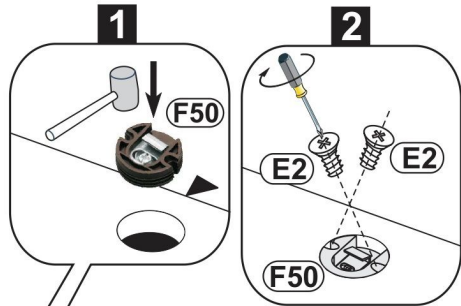
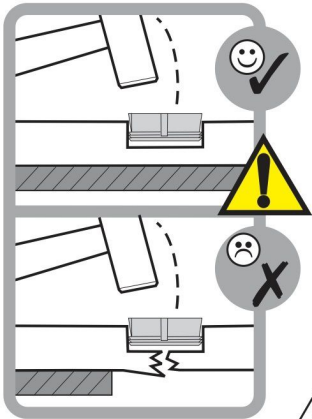
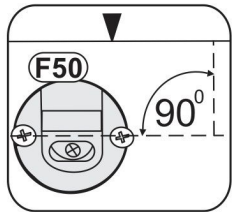
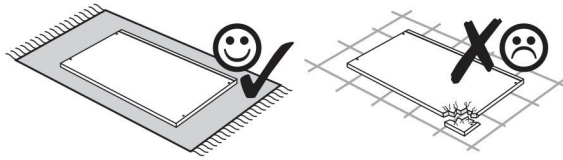
- C18**  x3
- F50**  x3
- E2**  5x11 x6

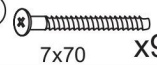

2

- K2**  7x70 x9
- K3**  x1

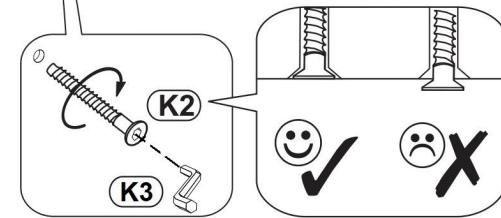
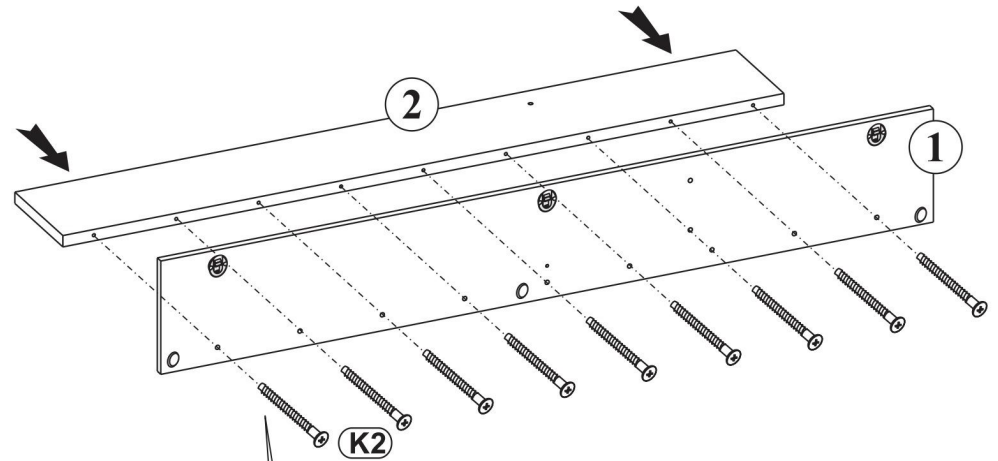

3

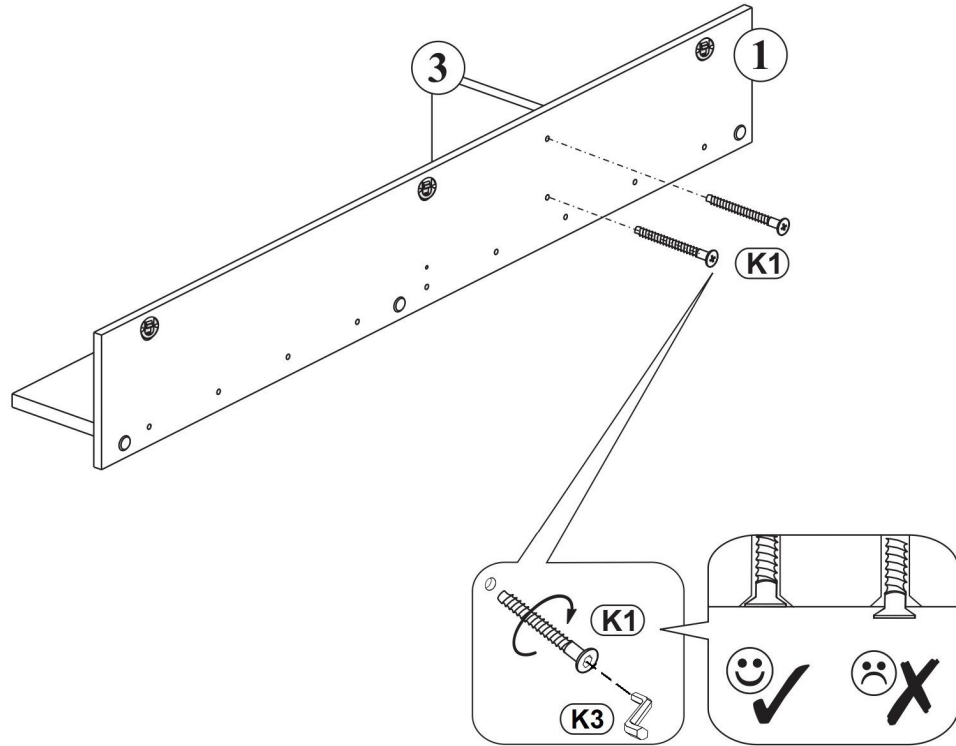
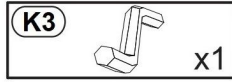
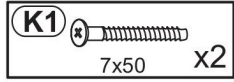

4

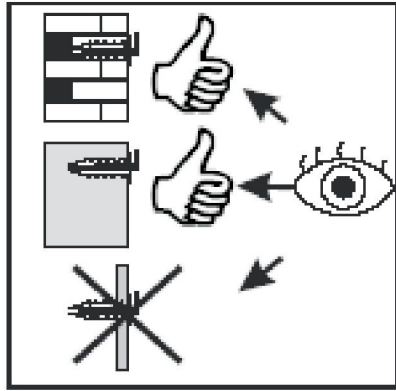

- T13** 10x50 mm X3
- T10** X3
- S25** 4x70 X1
- S26** 8x50 mm X1
- C14** X1

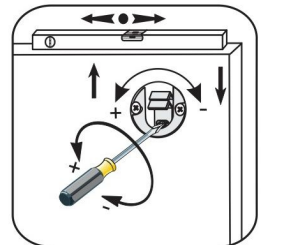
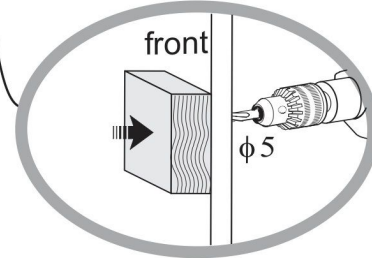
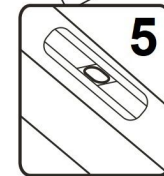
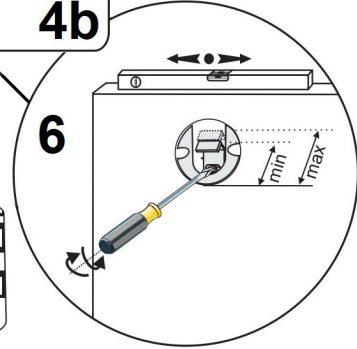
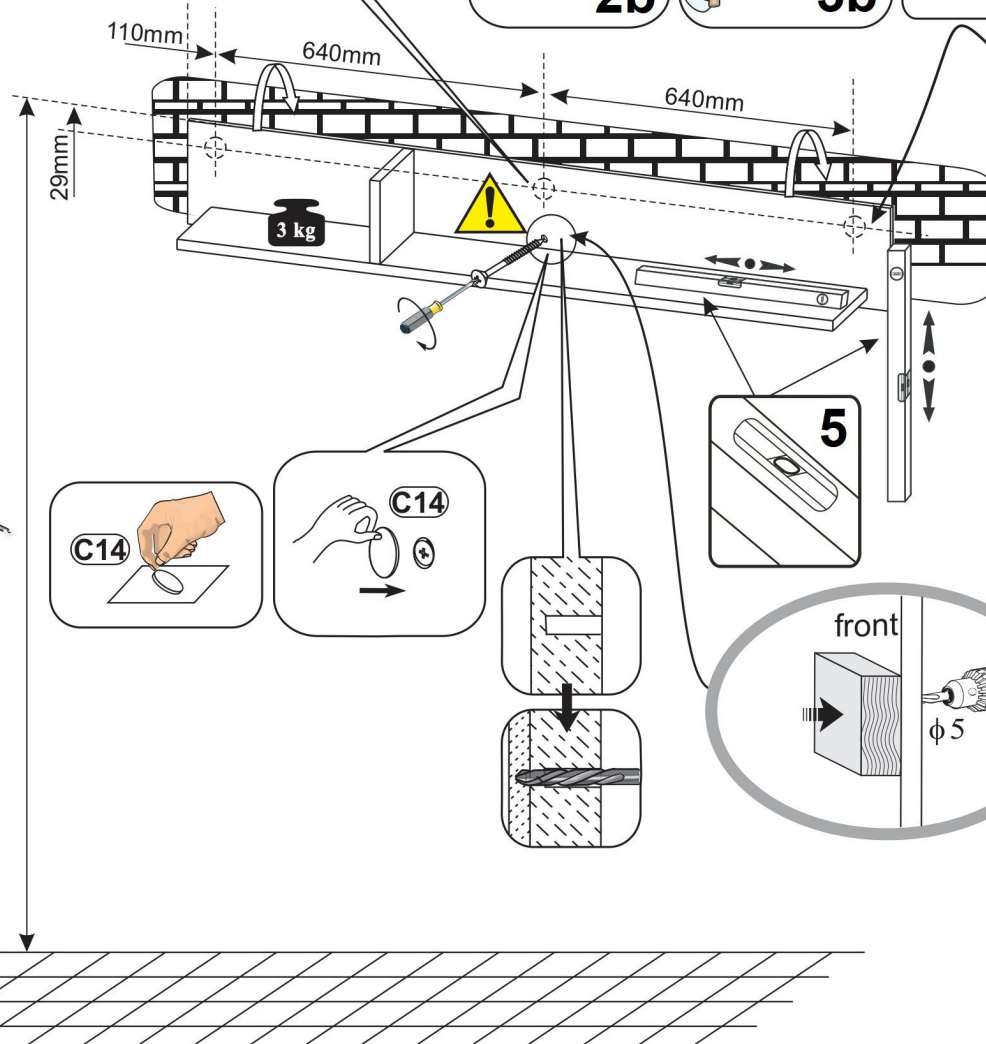
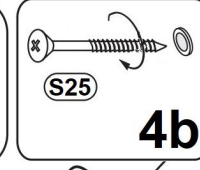
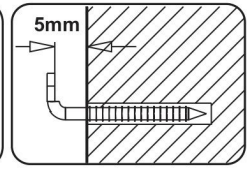
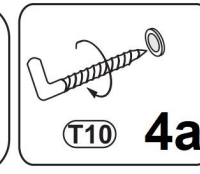
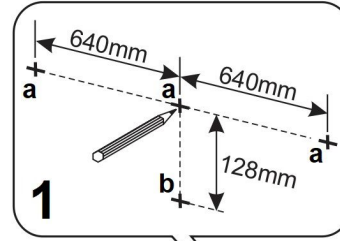
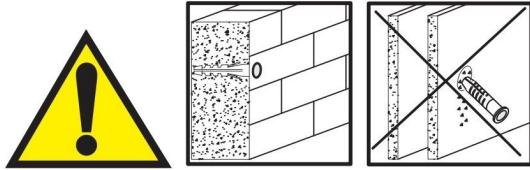

D CH AT LI LU
GB US
FR BE NC
NL
IT
SI
XS HR BA
HU
BG
CZ SK
SE
RO
ES

Kleintelle und Verpackungsfolien bei der Möbelmontage von Kindern fernhalten!
Keep small parts and plastic film out of the reach of children!
Tenir les petites pièces et les films plastiques hors de la portée des enfants!
Houd de kleine onderdelen en de plastic folie uit de buurt van kinderen!
Tenere i componenti di piccole dimensioni e le pellicole di plastica fuori dalla portata dei bambini!
Majnhn delov i embalazne folije pri montaži pohišnja priane dosega otrok!
Male dijelove i foliju za pakovanje priklom montaže namještaja držite dalje od djece!
Bijorszerelés közben a kis alkatrészek és a csomagoló fóliák gyermekéktől távol tartandók!
Дребни детайли и опаковъчни фолия да се държат далеч от деца при монтажа на мебелите!
Pri montaži nabylku uchovávajúe drobne dily a obalové fólie z dosahu detí!
Vid möbelmontering ska smäddeklar och förpackningsfolien hållas oåtkomliga för barn!
Tineit departe de copii piesele mici și folia de ambalat la montarea mobilierului!
iDurante el montaje, mantenga alejados de los niños las piezas pequeñas y el material plástico de embalaje!

D CH AT LI LU
GB US
FR BE NC
NL

Möbelmontage muss auf ebenem Untergrund erfolgen. Bei Wandmontagen immer geeignetes Befestigungsmaterial verwenden.
Furniture must be assembled on a flat surface. For assembly to the wall only use suitable fixing materials.
Le meuble doit être monté sur une surface plane. Pour le montage mural, utilisez des accessoires de fixation adaptés au type de mur.
De meubels dienen ob een vlakke ondergrond te worden gemonteerd. Voor wandmontage moeten geschikte bevestigingsmaterialen worden gebruikt.

IT
SI
XS HR BA
HU
BG

Il montaggio dei mobili deve avvenire su un fondo piano. Per il montaggio si prega di utilizzare solo materiali adatti.
Pohišto je treba montirati na ravni podlagi. Pri stenski montaži vedno uporabite pritrditveni material.
Namještaj se mora montirati na ravnoj podlozi. Kod montaže na zid uvijek koristite prikladan materijal za pričvršćivanje.
A bútorszerelését sikk felületen kell végezni. Falra szereléshez mindig megfelelő rögzítanyagot kell használni.
Материалът на мебелите да се извършва на равна основа. При стънен монтаж винилите да се използва подходящ крепежен материал.

CZ SK
SE
RO

Montáž nabylku provádějte na rovném podkladu. Při montaži na stěnu používejte vždy vhodný příslušenací materiál.
Montering av möbeln måste göras på jämnt underlag. Vid väggmontering ska lämpligt uppfästingsmaterial användas.
Montarea mobilier trebuie să se realizeze pe o pardoseală dreaptă. La montarea la perete utilizați întodeauna material de fixare adecvat.

ES El montaje debe efectuarse sobre una superficie uniforme. En el montaje mural emplee siempre el material de fijación adecuado.

D CH AT LI LU
GB US
FR BE NC

Bitte beachten Sie die Montageanleitung. Halten Sie immer die angegebene Wattzahl ein. Verhindern Sie einen Hitzestau.
Please observe the assembly instructions. Do not exceed the max. given wattage. Ensure that the heat is not allowed to build up.
Veuillez respecter la notice de montage. Respectez impérativement le nombre des watts maximal. Veillez à éviter toute accumulation de chaleur.

NL
IT

Lees a.u.b. de montagehandleiding door. Houd u beslist aan het max. opgegeven wattage. Zorg ervoor dat geen hittehuwling onstaat.
Attenersi alle istruzioni di montaggio. Rispettarsi rigorosamente il numero di watt max. indicato. Assicurarsi che non si verifichi un accumulo di calore.

SI
XS HR BA
HU
BG

Upoštevajte navodila za montažo. Vedno upoštevajte navedeno število vatov. Preprečite zastoj vročine.
Obratite molino Vas pozor na uputu za montažu. Uvijek se pridržavajte navedenog broja vati. Izbjegavajte zastoj vrućine.
Vegye figyelembe a szerelési útmutatót. Mindig tartsa be a megadott wattszámot. Akadályozza meg a hőstagnációt.
Мощ, вземете под внимание ръководството за монтаж. Спазвайте винилите посочените ватове. Избягвайте акумулиране на топлина.

CZ SK
SE
RO
ES

Dodržujte prosím návod k montáži. Vždy dodržujte uvedenu hodnotu výkonu (watt). Zabráňte tak přehřívání.
Fóji monteringsanvisningen. Fóji alltid angivet watttal. Undvik att hetta uppstår.
Respectați instrucțiunile de montaj. Respectați întodeauna numărul de watt impus. Evitați acumularea de căldură.
Le rogamos que tenga presente las instrucciones de montaje. Respete siempre el número indicado de vatios. Evite la acumulación de calor.

D CH AT LI LU
GB US
FR BE NC
NL
IT
SI
XS HR BA
HU
BG
CZ SK
SE
RO
ES

Halten Sie die max. zulässigen Belastungswerte der Möbelteile ein. Details siehe Montageanleitung
Comply with the max. permissible loads. For details, please refer to the assembly instructions
Respectez les valeurs de charge max. admissibles des parties de meubles. Pour plus de détails, cf. la notice de
Houd de maximaal geoorloofde belastingswaarden van de meubeldelen aan. Voor details verwijzen wij naar de montagehandleiding
Rispettare la portata max. permessa degli elementi del mobile. Per dettagli si vedano le istruzioni di montaggio e si vada
Upoštevajte največjo dovoljeno obremenitev delov pohišnja. Podrobnosti najdete v navodilih za montažo in na
Pridržavajte se maks. dovoljenih vrijednosti opterećenja elemenata namještaja. Detalje vidí u uputu za montažu
Tartsa be a birtorelemek max. megengedett terhelési értékét. A részleteket lásd a szerelési útmutatóban
Спазвайте макс. допустимите стойности на натоварване на мебелите. За подробности виж ръководството за монтаж
Dodržujte max. přípustné hodnoty zatížení nabylkových dílů. Podrobnosti viz návod k montáži
Fóji max. tillåten belastning av möbeldelarna. Mer information finns i monteringsanvisningen
Respectați valorile de solicitare max. admise pentru corpurile de mobilier. Pentru detalii consultați instrucțiunile de montaj
Respete los valores máximos de carga admisibles para las piezas de los muebles. Consulte los detalles en las instrucciones

D CH AT LI LU
GB US
FR BE NC
NL
IT
SI
XS HR BA

Zur Möbeleringung ein mit Wasser befeuchtetes, fusselfreies Baumwolltuch verwenden. Gereinigte Flächen immer trockenreiben!
To clean the furniture only use a water dampened lint-free cotton cloth. Once cleaned, always wipe the surfaces dry.
Utilisez un chiffon en coton non pelucheux humidifié avec de l'eau pour nettoyer les meubles. Séchez systématiquement les surfaces nettoyées en les frottant à sec!
Gebruik een met water bevochtigde, pluistvrije katoenen doek om de meubels te reinigen. Wrijf gereinigde oppervlakken altijd droog!
Per pulire il mobile utilizzare un panno di cotone inumidito d'acqua e che non perde pelucchi. Asciugare sempre le superfici che si sono pulite!
Za čišćenje pohišnja uporabljajte vlažno bombažno krpo, ki ne pušča vlaken. Očiščene površine vedno obrišite do suhlega!
Za čišćenje namještaja koristite sa vodom navlaženu pamučnu krpu koja ne ispušta vlakna. Očiščene površine uvijek obrišite suhom krpom!

HU
BG

Bűtorisztáshoz vizet be nedvesített, nem szárazodó pamutkenőt használjon. A megtisztított felületeket mindig törölgje szárazra!
За почистване на мебелите използвайте навлажнена с вода, неизсушваща влажна памучна кърпа. Почистените повърхности винаги да се изтриват до сухо!

CZ SK
SE
RO

K čištění nabylku používejte bavlněný hadr neuvoloňující vlákna, navlhčený ve vodě. Vyučštěné plochy vždy utřete do sucha!
För möbeleröring används en luddfri bomullstuck tuktad med vatten. Rengörda ytor ska alltid torkas torra!
Pentru curățarea mobilier utilizați o lavetă din bumbac fără saame umezită cu apă. Suprafețele curățate se șterg întodeauna până se usucă!

ES

Emplee un paño de algodón humedecido con agua y líbre de pelusa para la limpieza de los muebles. ¡Seque siempre las superficies que ha limpiado!