

980345

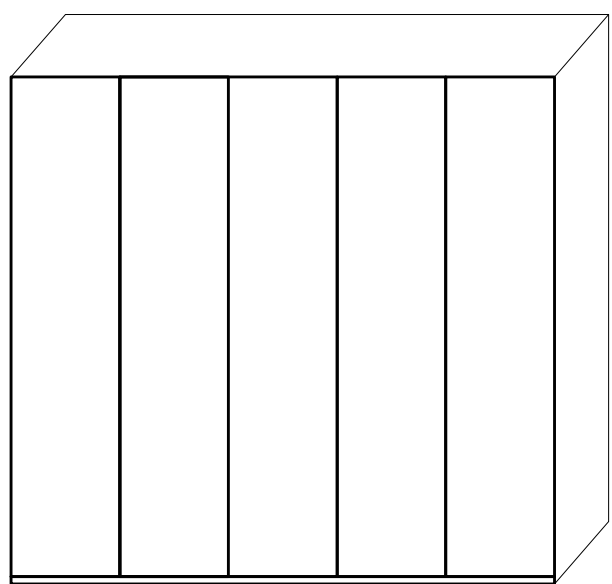

NSP 225

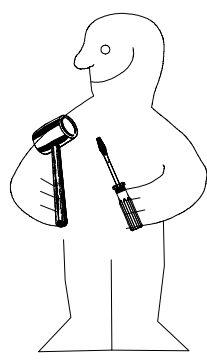
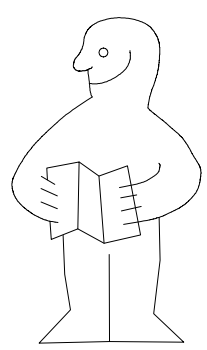
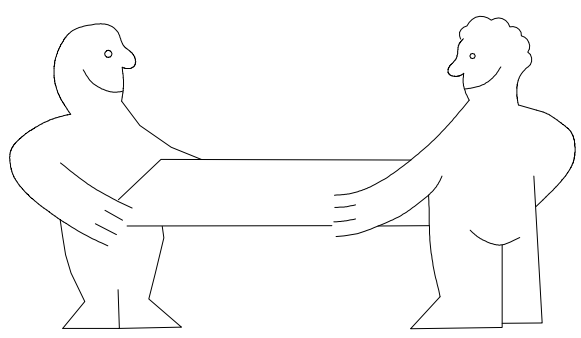
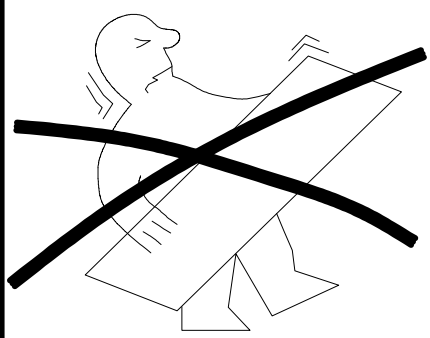

1-2-3-4... ○

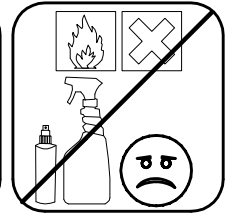
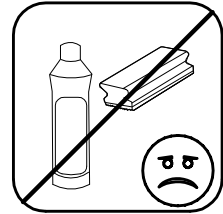
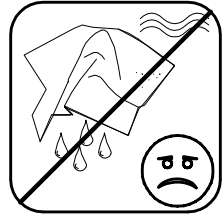
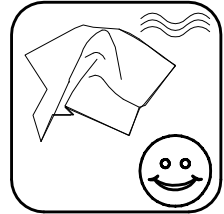
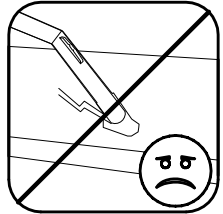
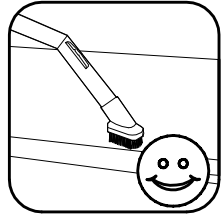
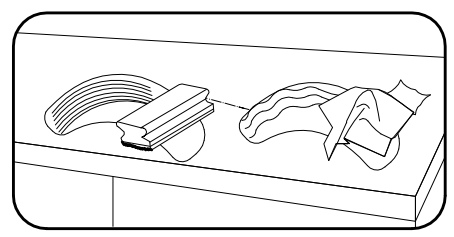
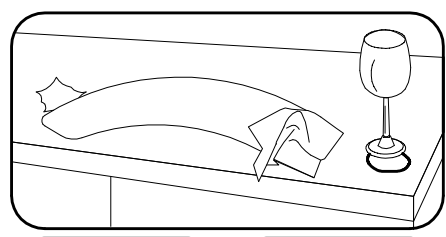
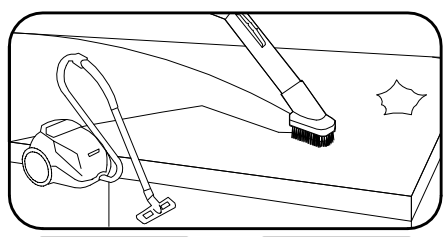
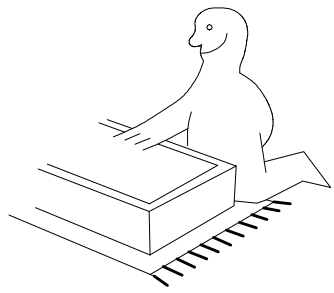
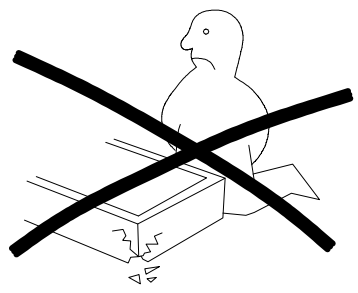
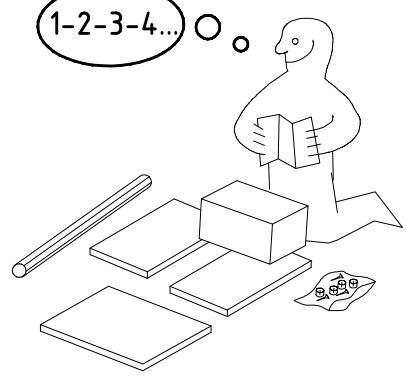





980345

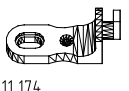

20.12.04 / 29.11.19

11 19

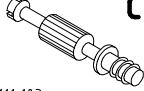
1/9

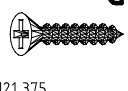
 111 102	<b>A</b> 16x
 111 610	<b>L7</b> 12x
 111 174	<b>J1</b> 6x

 111 103	<b>C</b> 16x
M6 x 11 mm  121 181	<b>T6</b> 6x
3,5 x 35 mm  121 375	<b>G14</b> 12x

424mm  112 403	<b>K21</b> 1x
870mm  112 402	<b>K20</b> 2x
3,5 x 15 mm  121 370	<b>G1</b> 12x

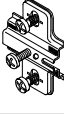
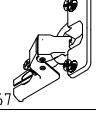
 117 001	<b>K1</b> 6x
 112 268	<b>M</b> 15x
 112 267	<b>N</b> 15x

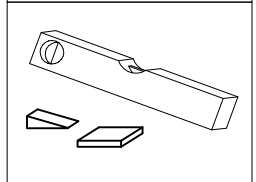
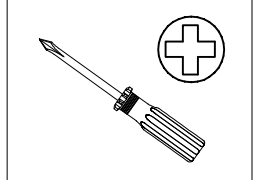
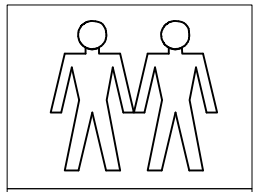
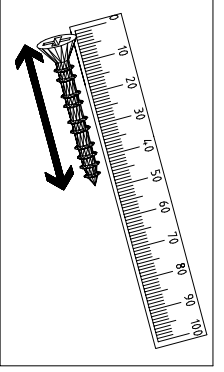
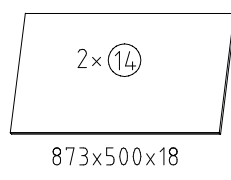
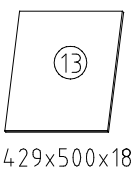
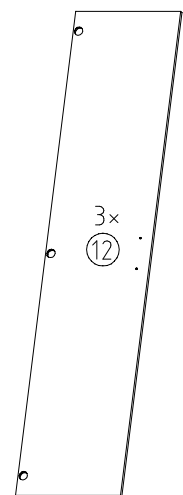
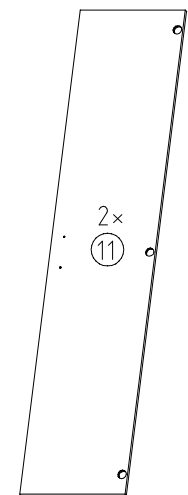
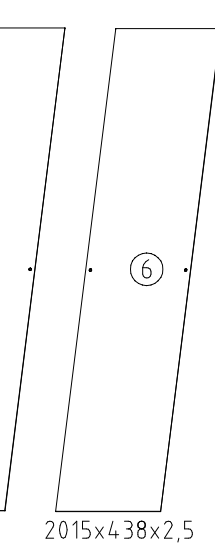
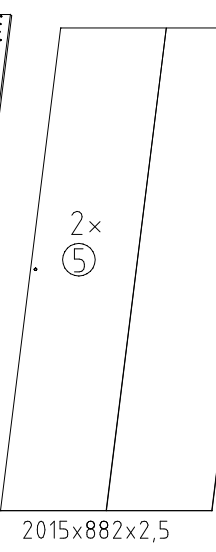
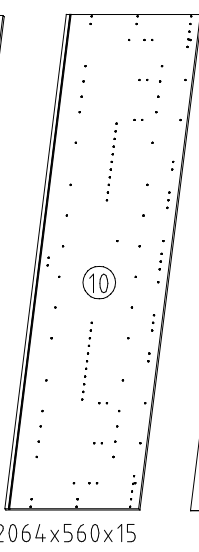
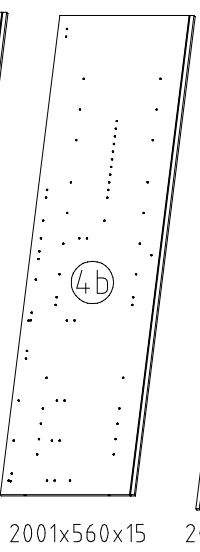
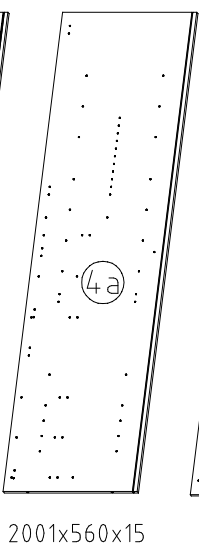
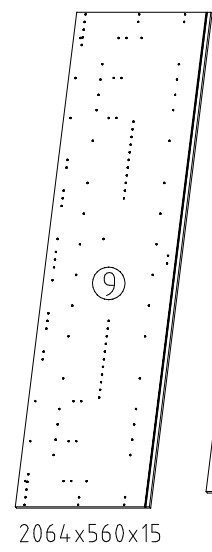
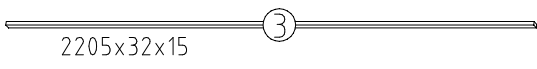
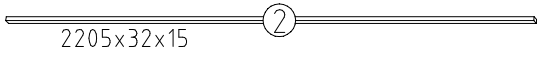
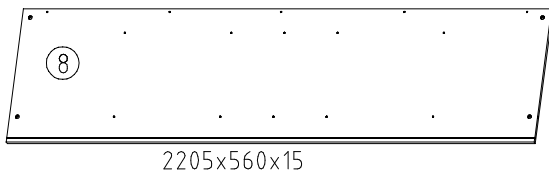
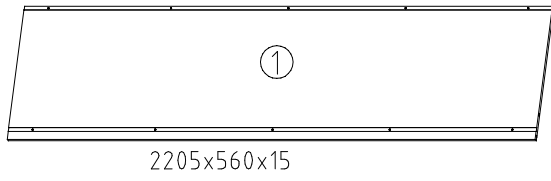
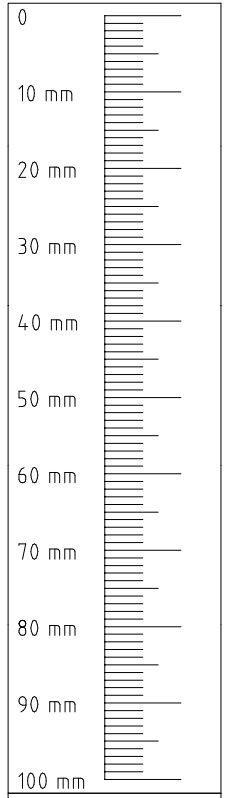

1

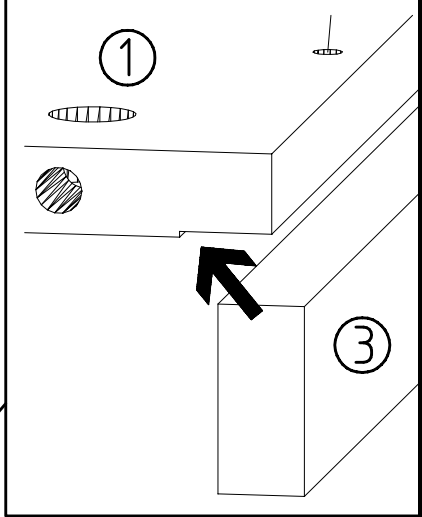
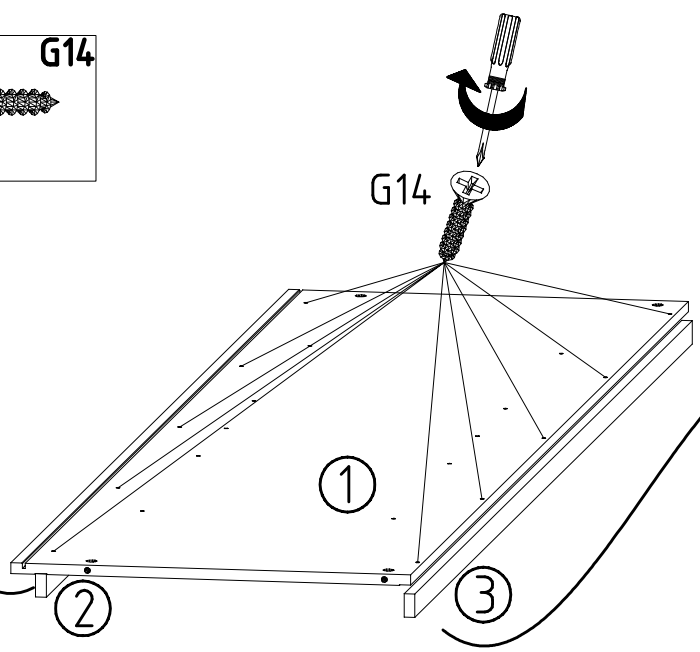
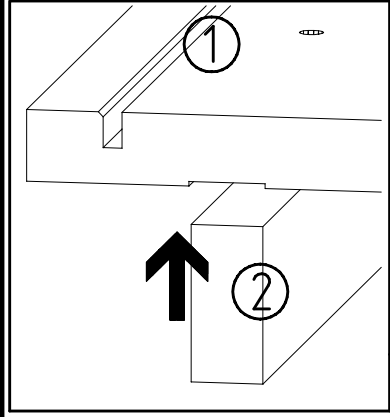
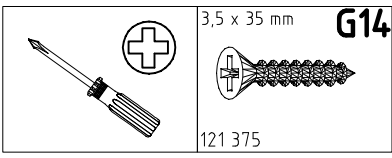

2

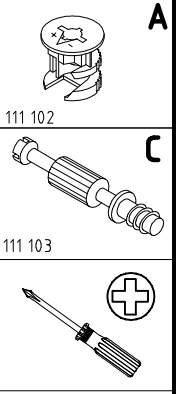
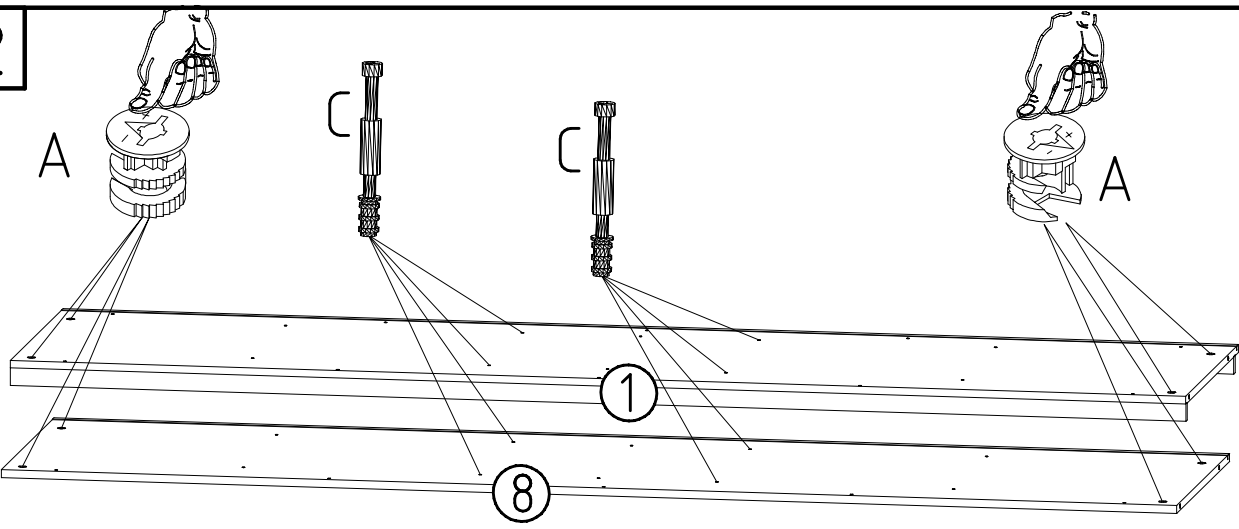

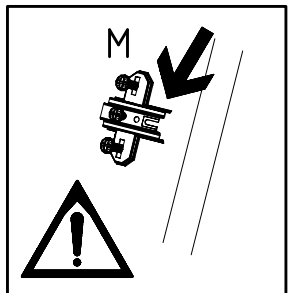
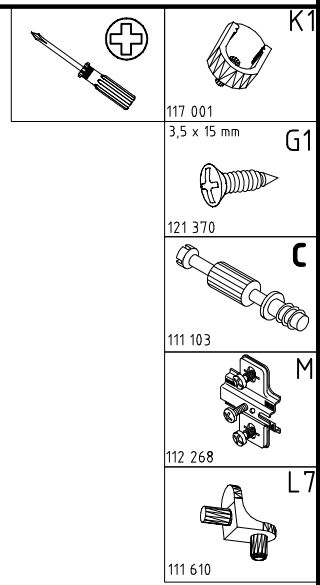
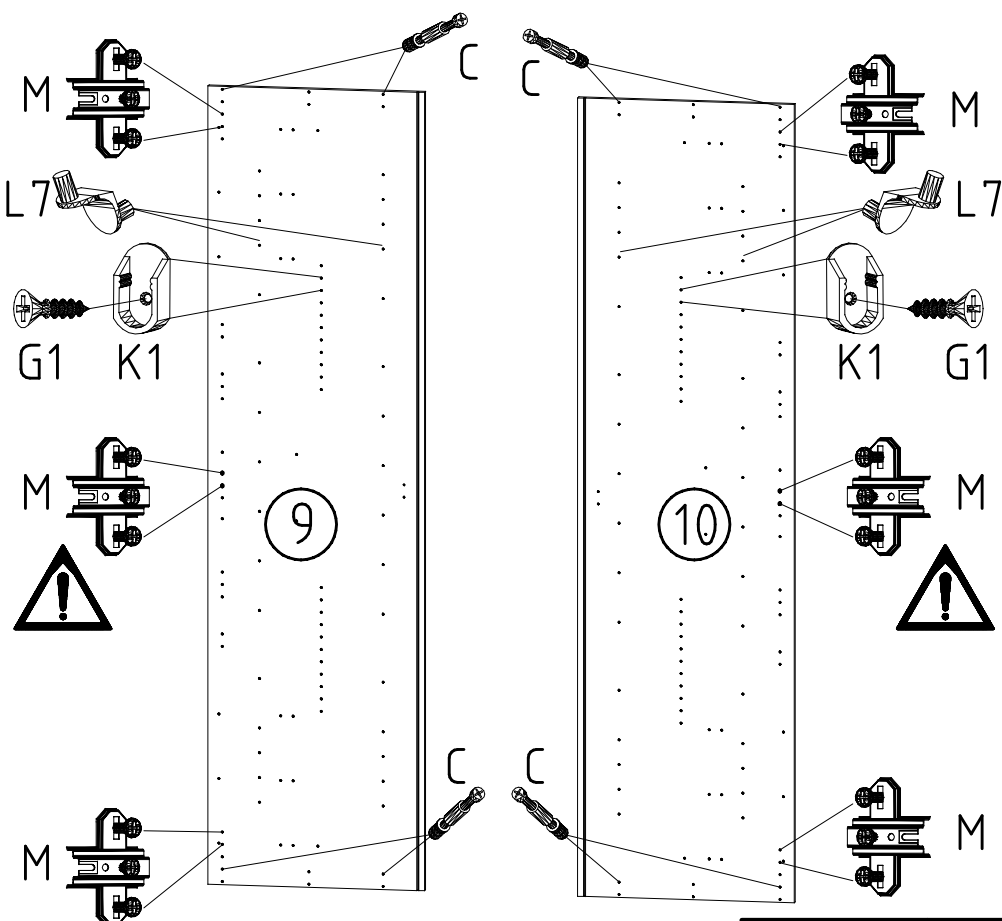

3



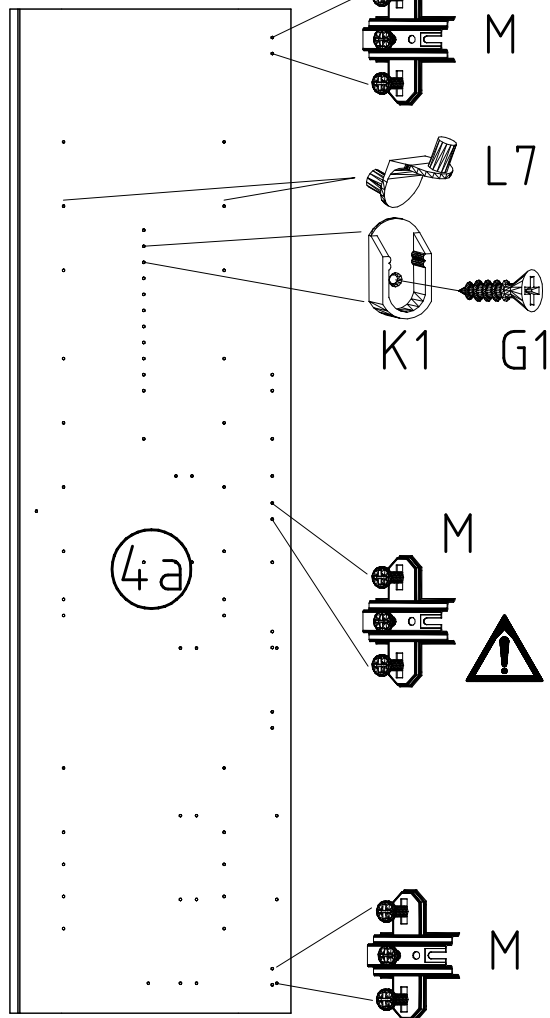
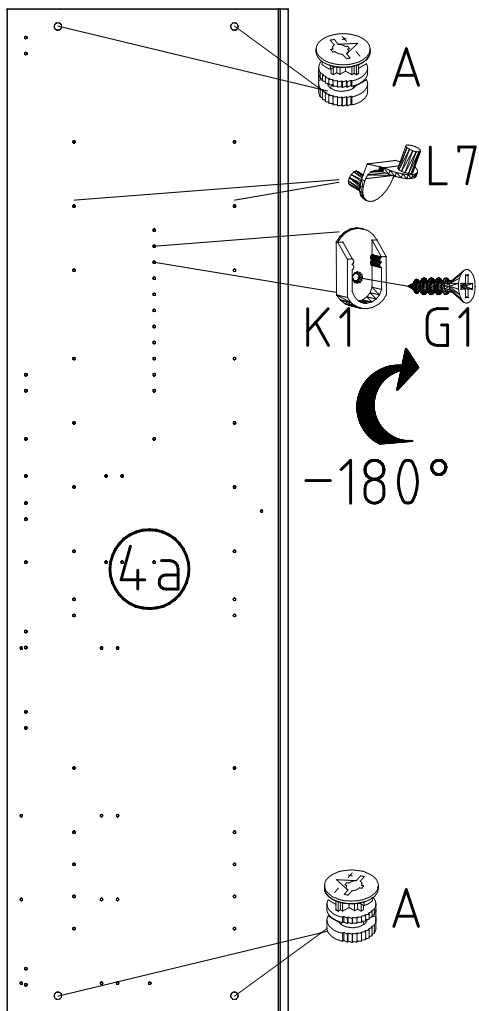

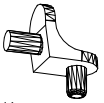

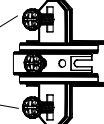
4

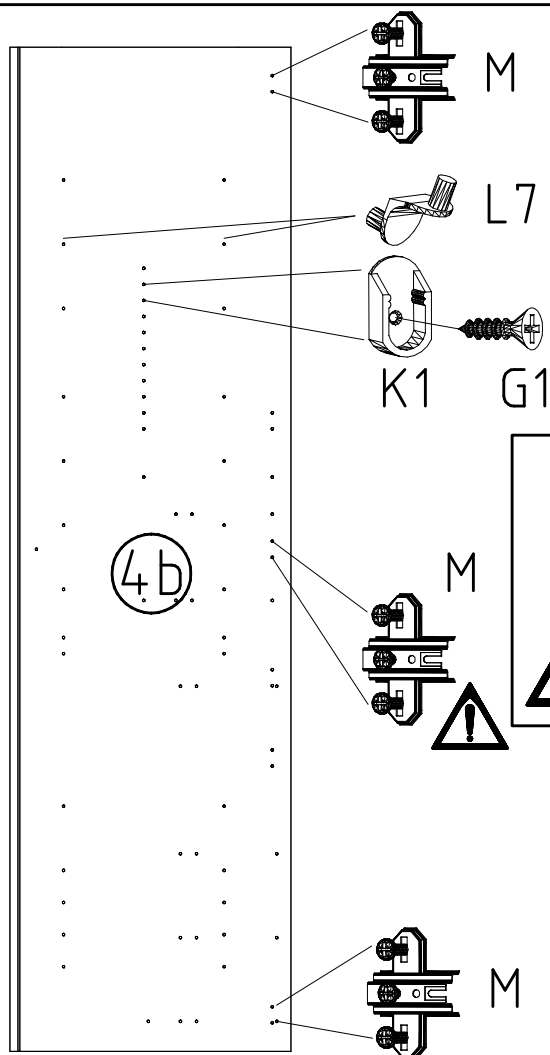
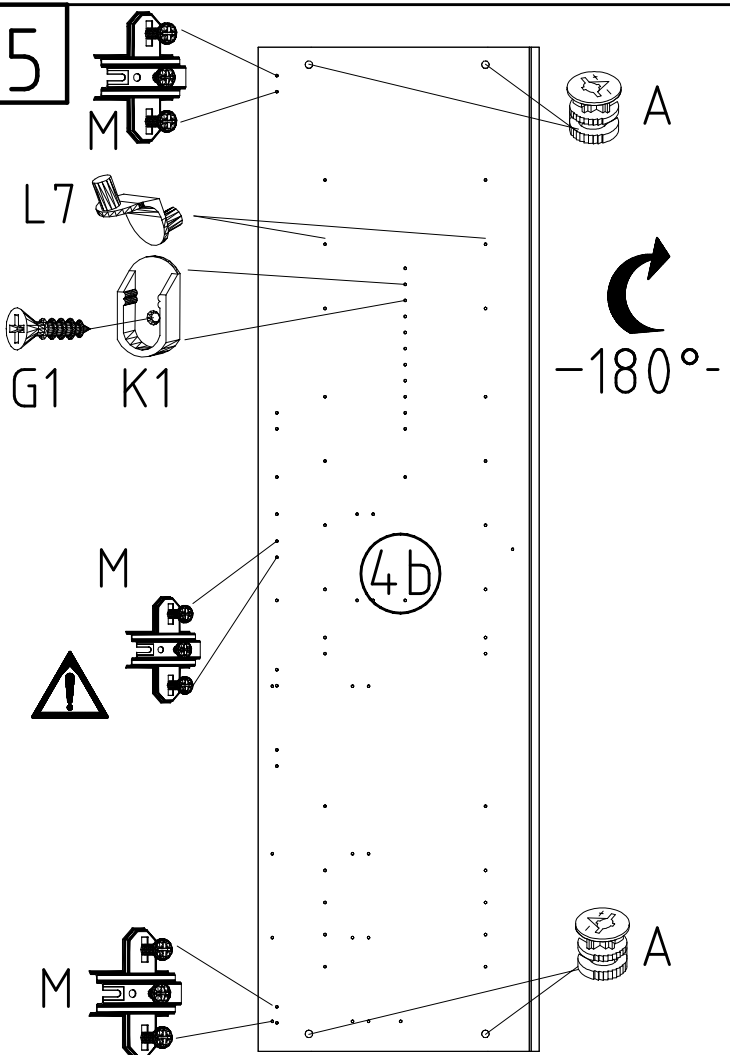

-  L7
- 111 610  
3,5 x 15 mm  G1
- 121 370  K1
- 117 001  M

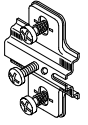
5

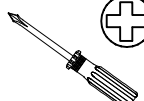

-  M
- 112 268  A
- 111 102  

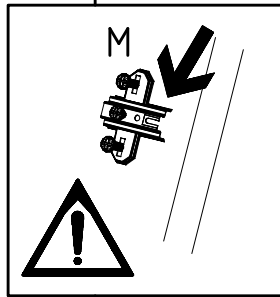

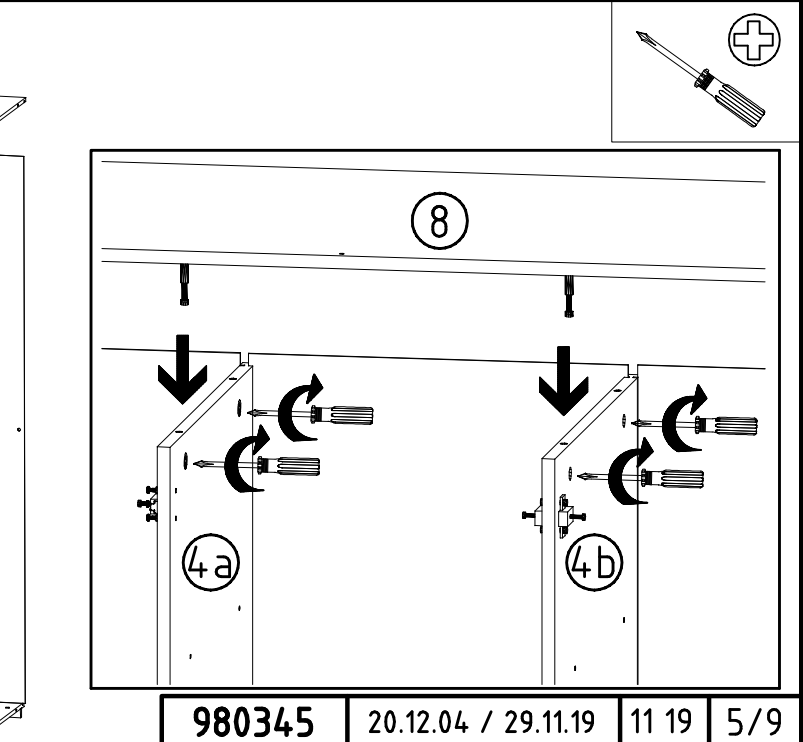
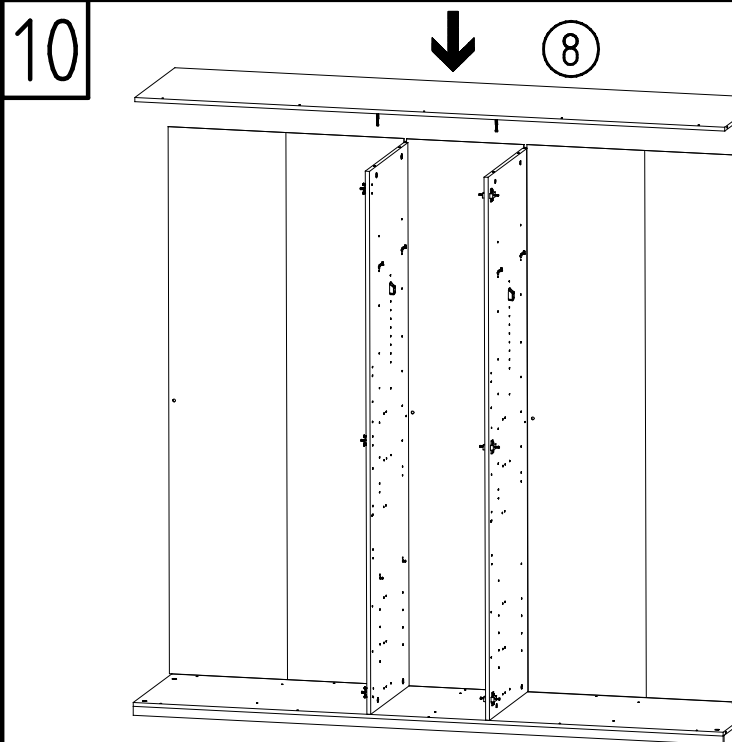
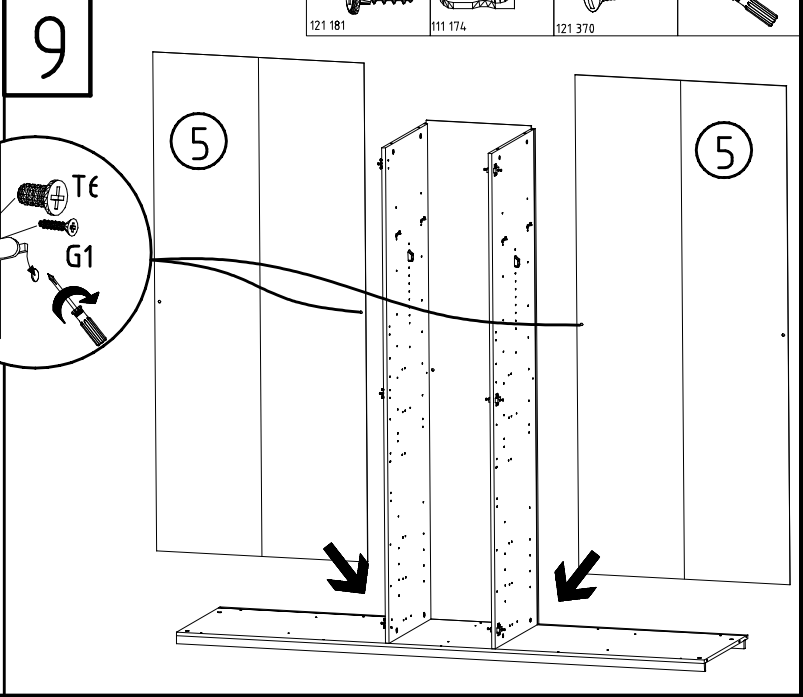
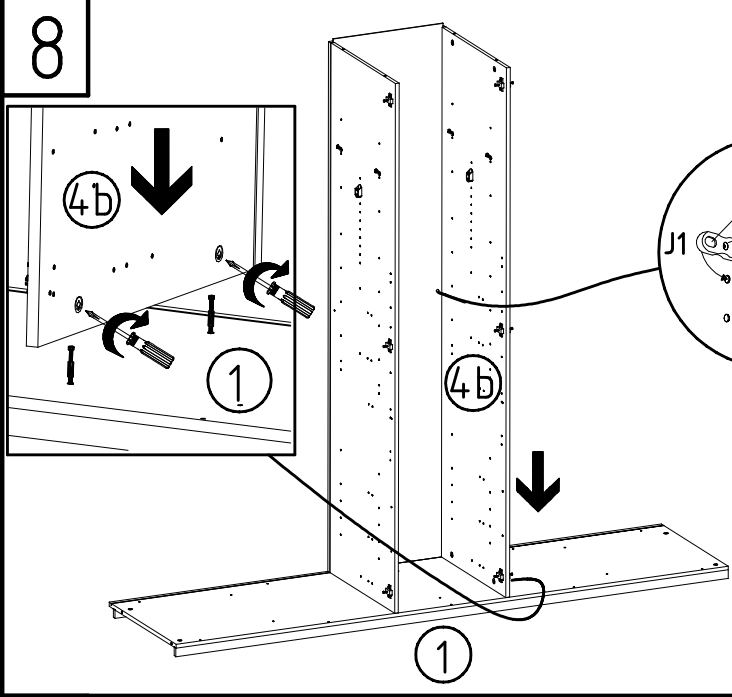
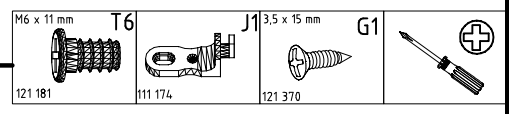
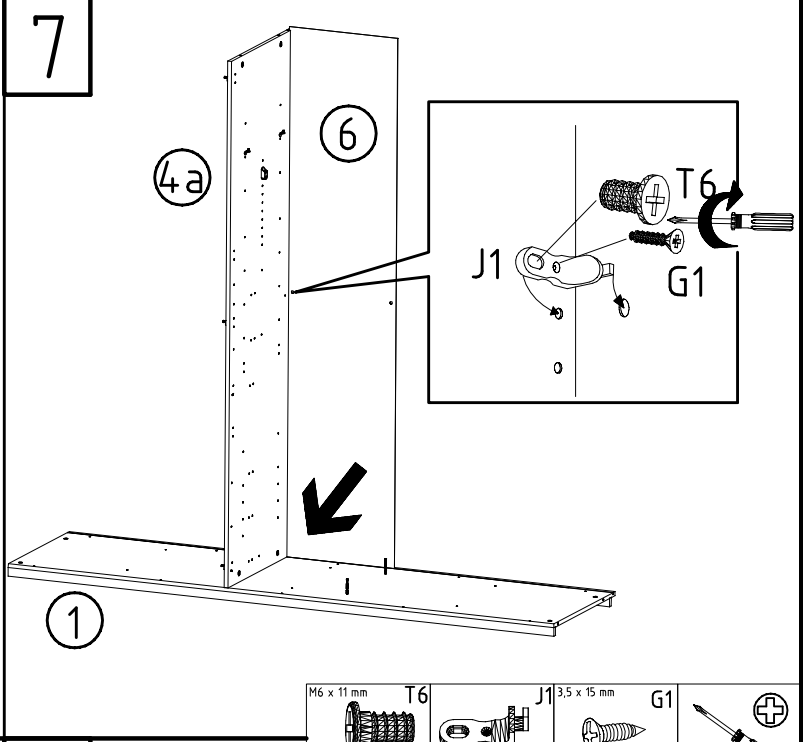
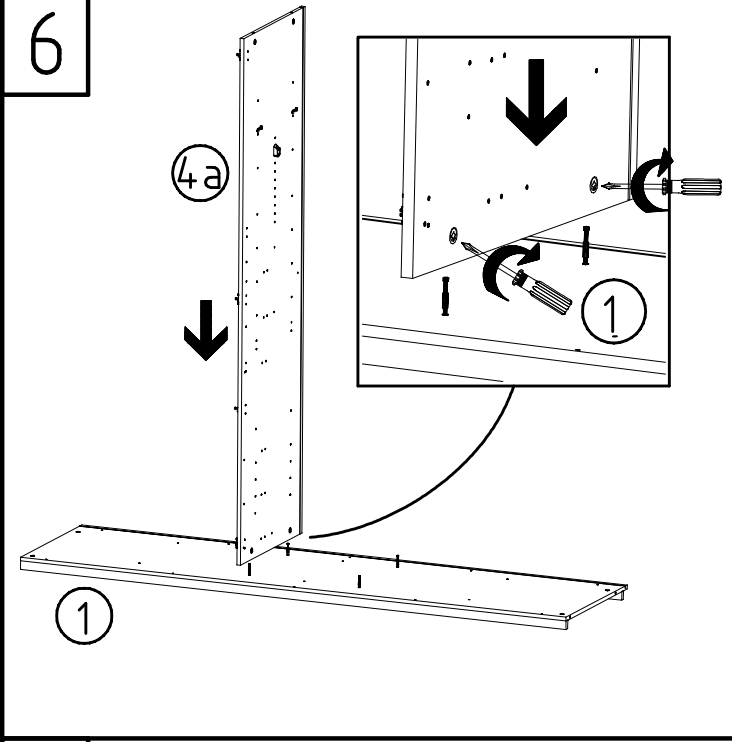

11

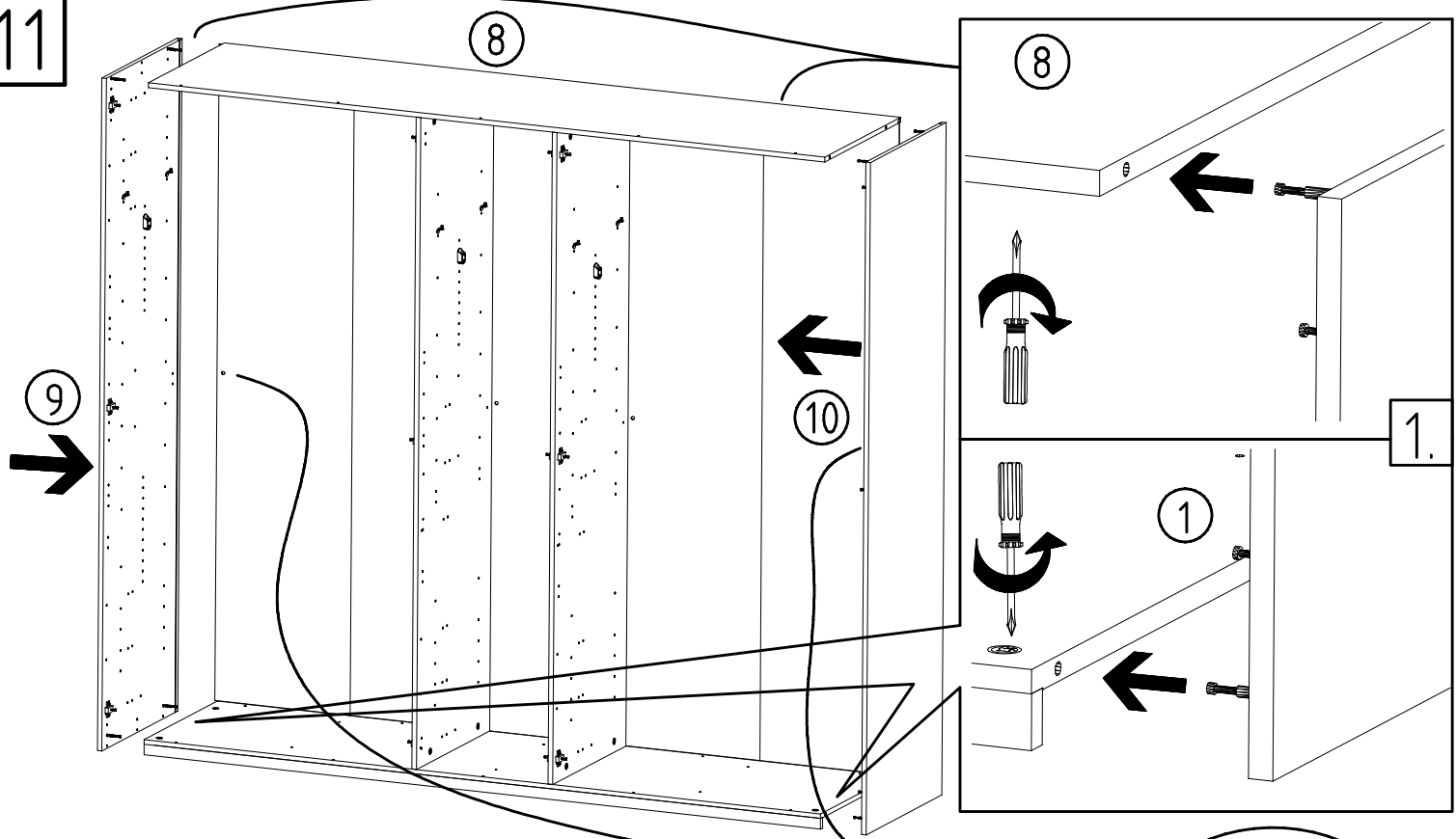

	M6 x 11 mm T6	J1 3,5 x 15 mm	G1
	121 181	111 174	121 370

12

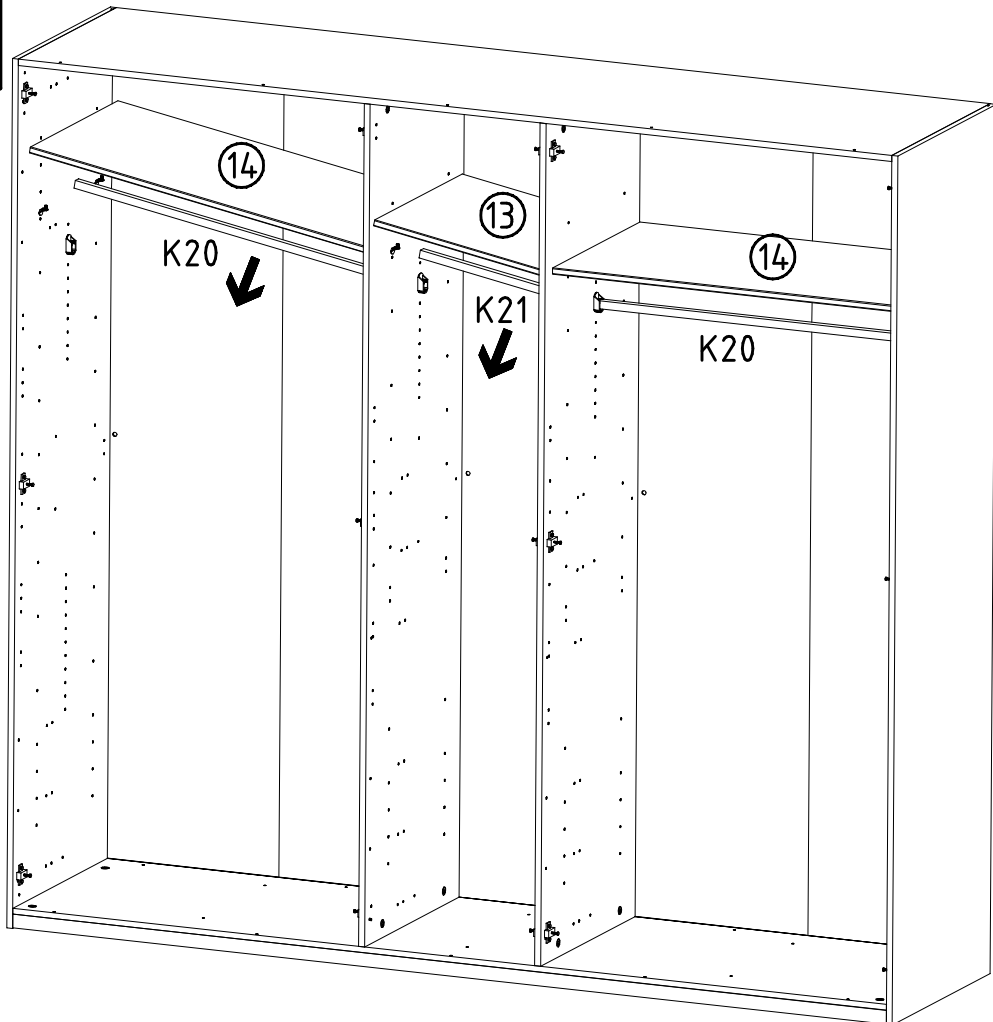

	K20
870mm	
112 402	
	K21
424mm	
112 403	

13

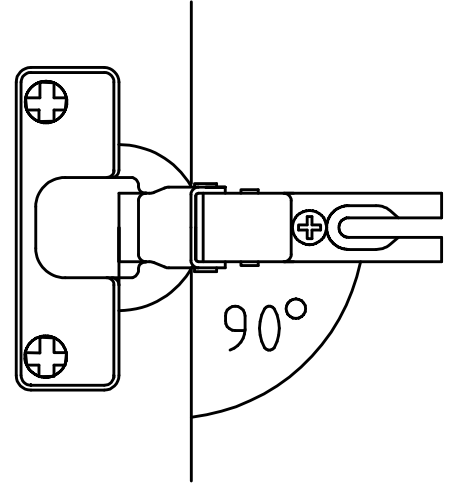
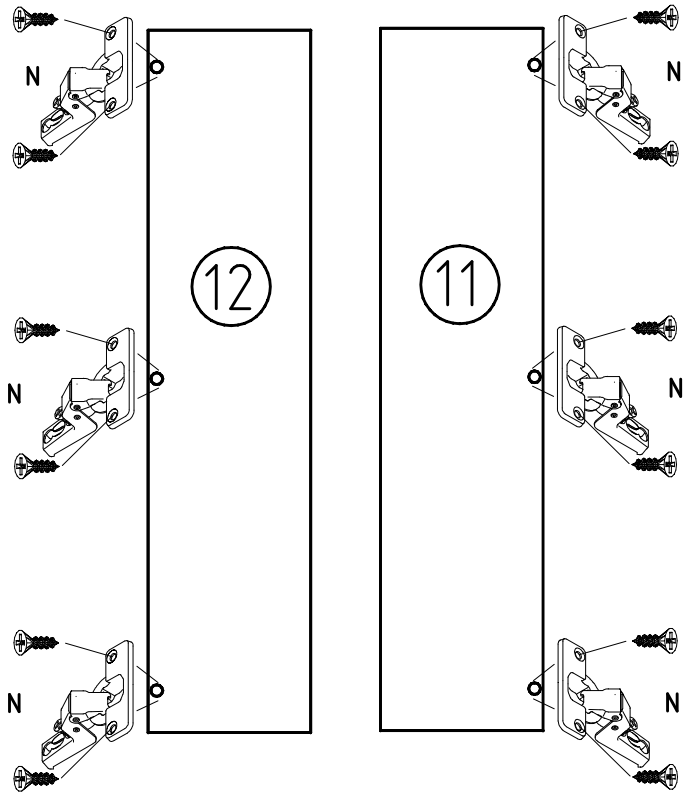
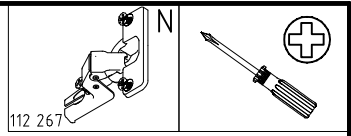

14

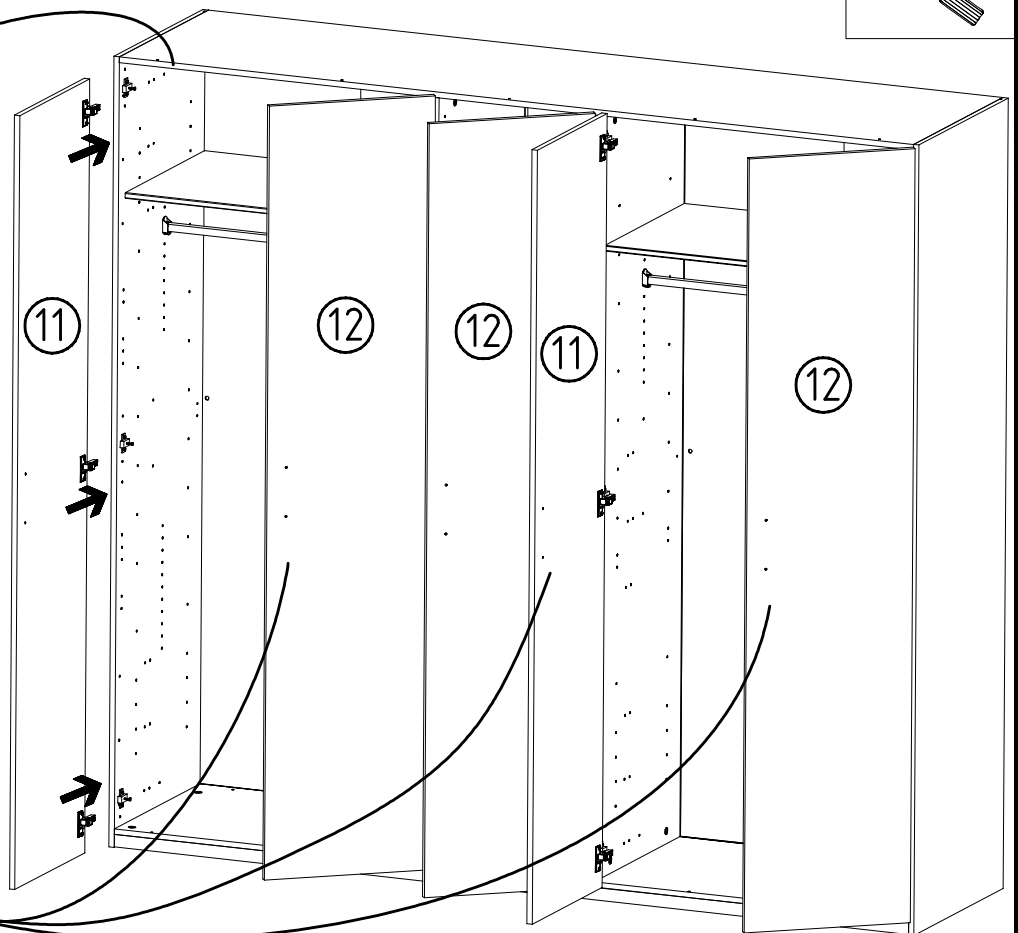
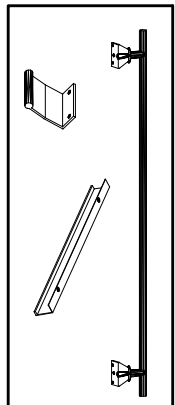
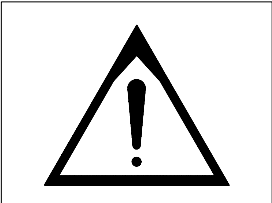
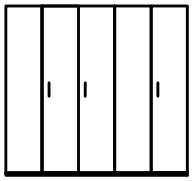
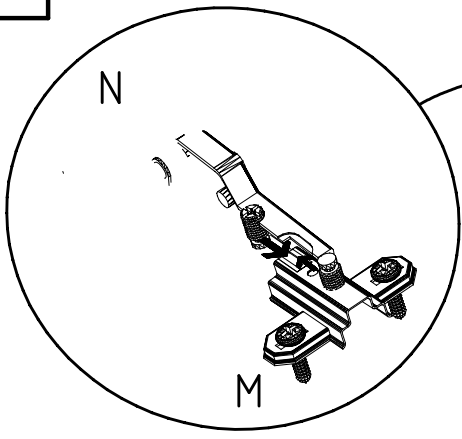
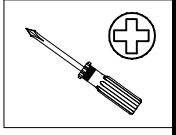

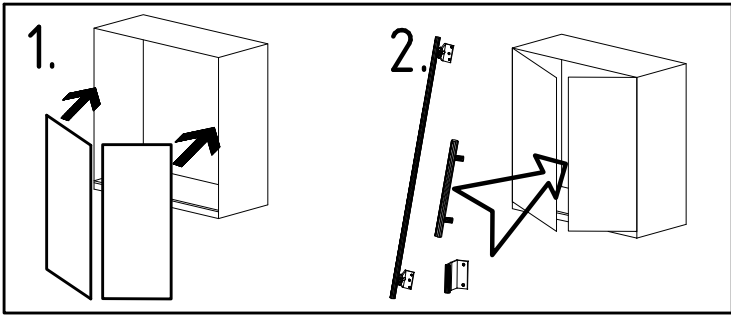
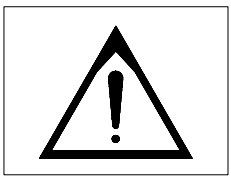

3,5 x 15 mm 121 370	G1	4,0 x 12 mm 122 625	G56
------------------------	----	------------------------	-----

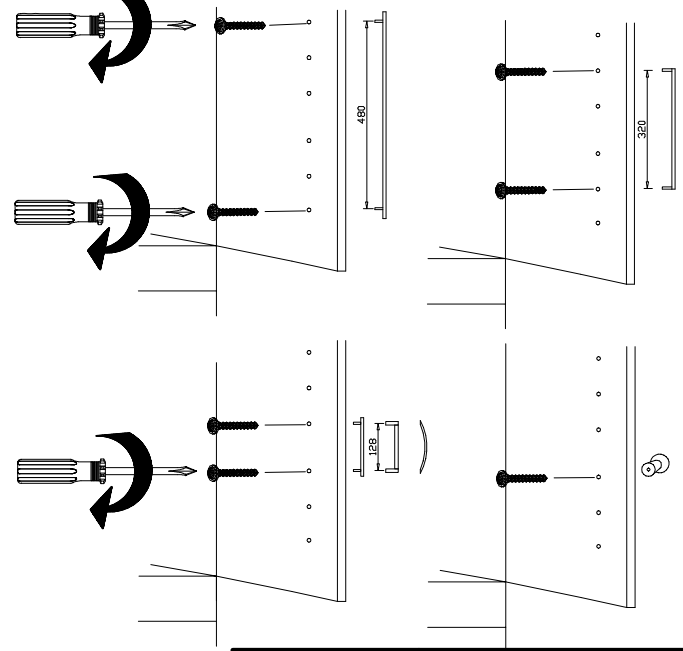
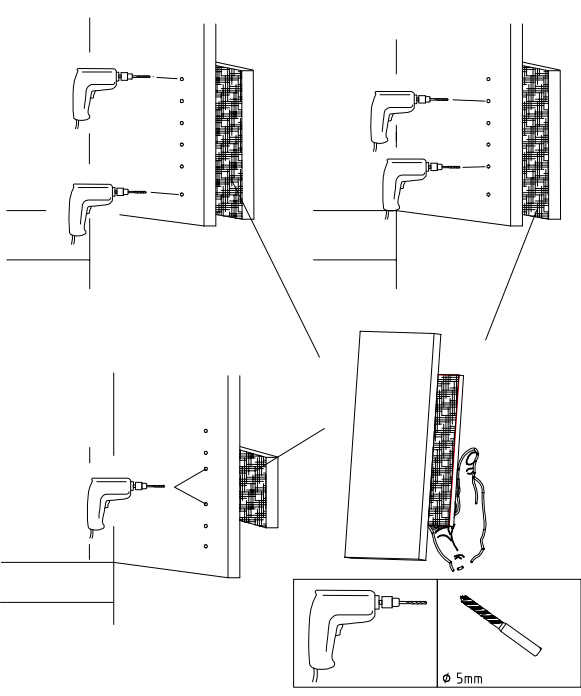
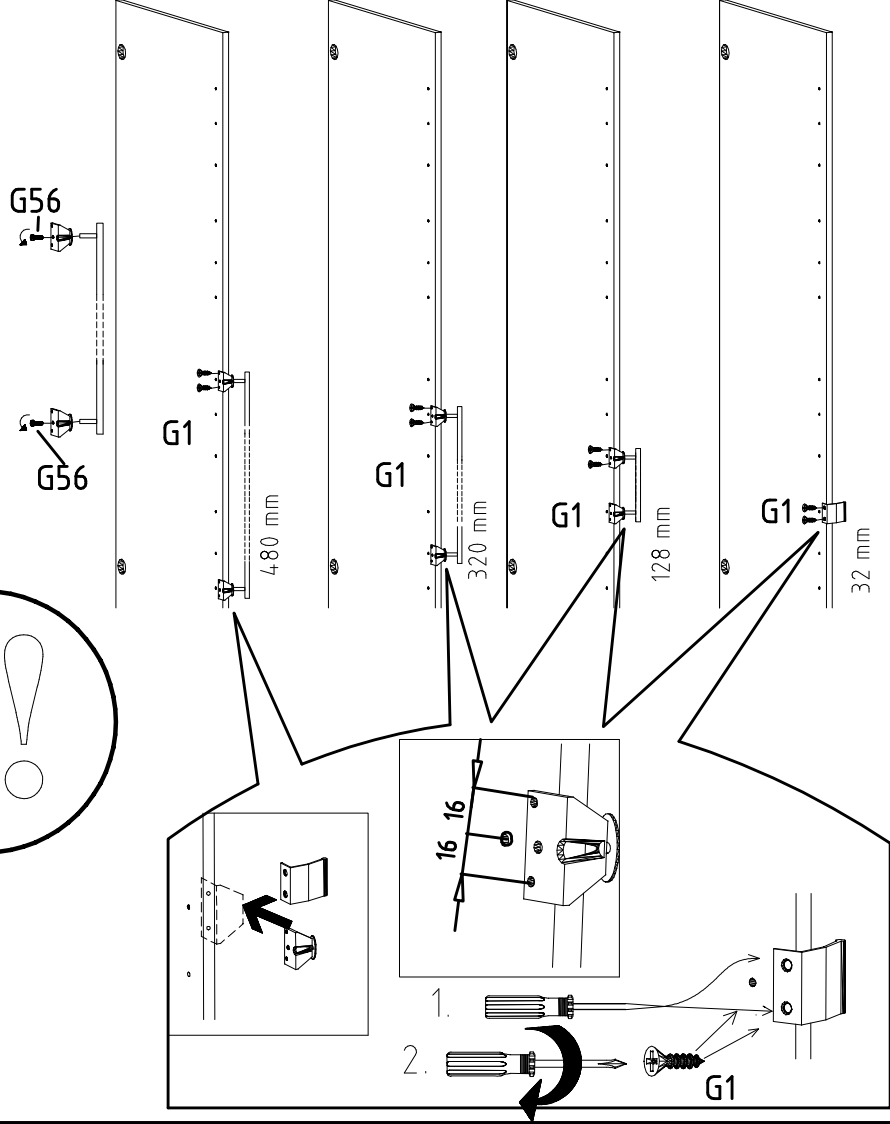
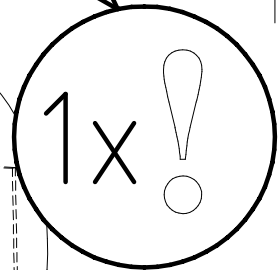
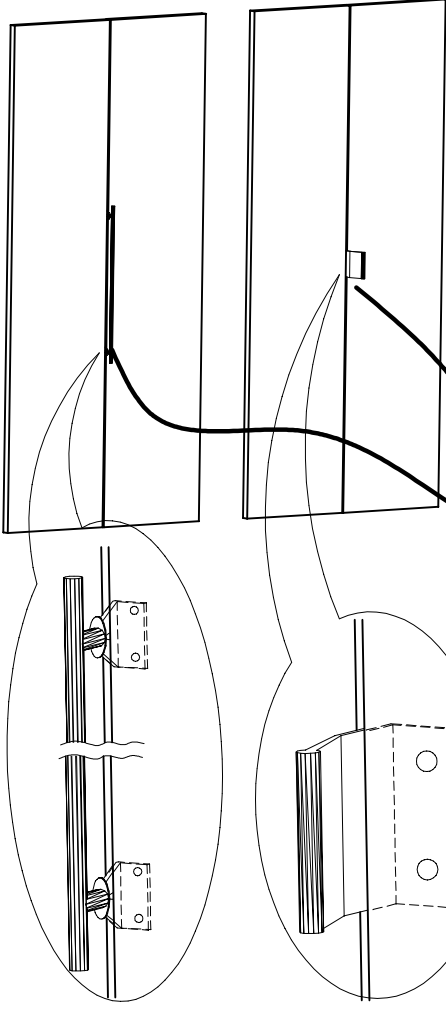

4 X 27mm
122620
4,0x22
G49
122 609



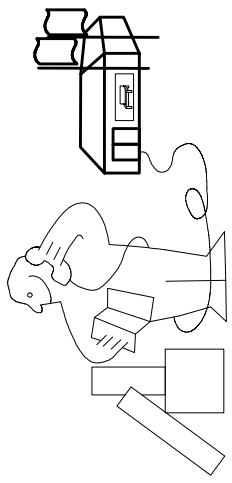
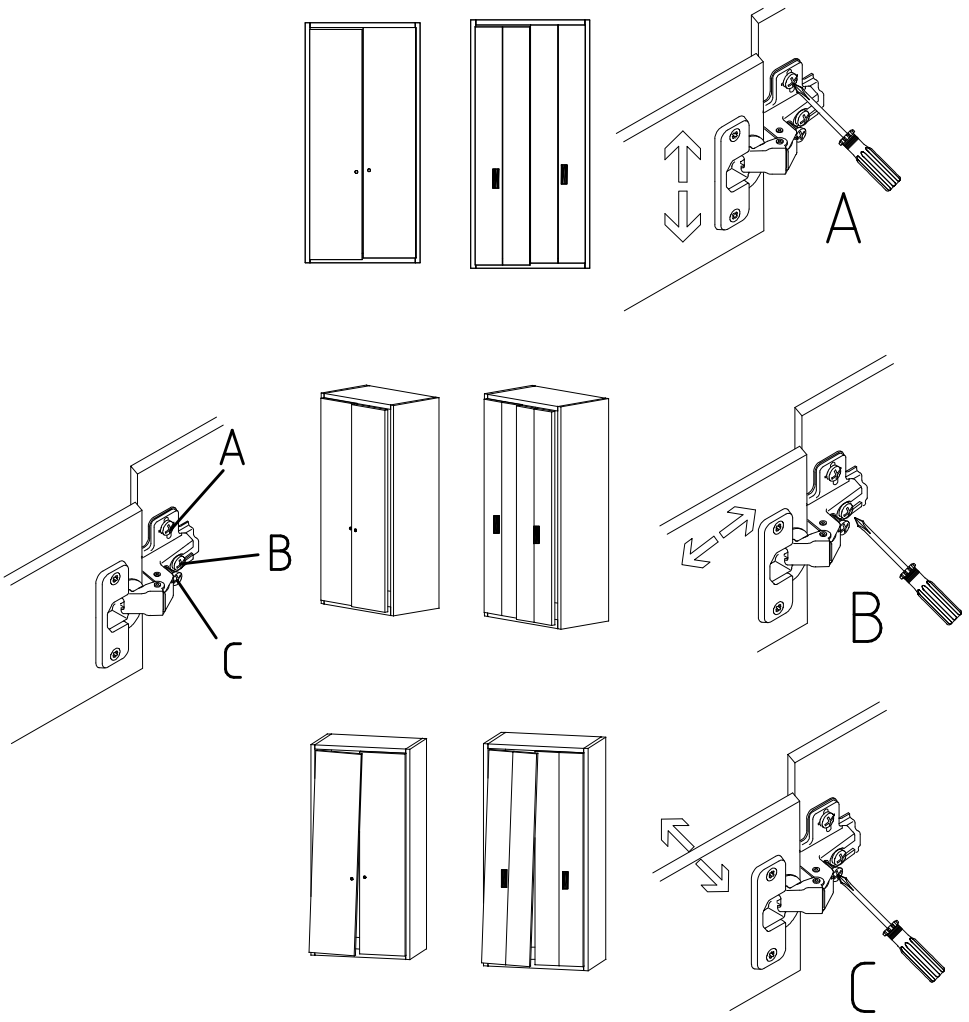

Modell/Model/Modèle

\_\_\_\_\_

\_\_\_\_\_

\_\_\_\_\_

\_\_\_\_\_

\_\_\_\_\_

\_\_\_\_\_

\_\_\_\_\_

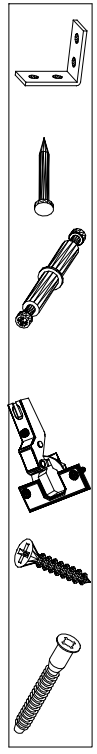
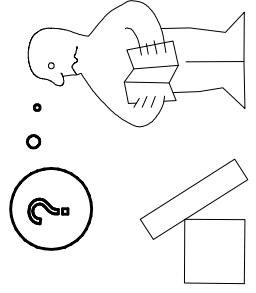
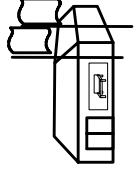
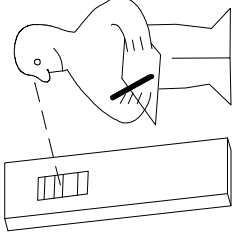

<121 370>	< G 1 >	<4x>

Änderungen die dem technischen Fortschritt geschuldet sind, behalten wir uns vor!  
 Bei nicht vorschriftsmäßiger und/ oder nicht fachmännischer Montage wird bei Personen- und/ oder Sachschäden keinerlei Haftung übernommen.  
 WIMEX Wohnbedarf/ Import Export Handels GmbH/ Postfach 1407/ 49112 Georgsmarienhütte/ Germany  
 Tel.:(+49) 05401 8598 72 Fax.:(+49) 05401 8598 33 Mail: service\_H@wimex-online.com

104P-NR. / 104P-NO.    150X-NR. / 150X-NO.    Auftrag/Order-No. / No. de Commande

**23203**    **30110XY**    104

Kunde    MAX MUSTERMANN  
Customer  
Client

Kommission / your order reference / votre reference

**3377 MINDEN**

---

Dekor / Decor    Decor / Modell / Modele

**F99**    **SAMPLE**

F99842    SCHWEBETUERENSCHRANK 250 CM H 216CM  
PLANKENEICHE NB + RAH STEEL  
PLANKENEICHE NACHBILDUNG

202320301107241476000001

Paket / Package / Paquet

**414760**

SOCKEL

Paket 1 von 8    Colli Kommission 10

HSP-SMT BOD 50 TEXT/TEX SOCKEL 32 FRESH    TV / LF 104  
SO-BOD TEXT RASTEX/ ZNBOD D18MM TX KLSTA

Montage - Anleitung    Laenge ..... 520,0    OBEREN  
KS-64    Breite ..... 568,0    OBEREN

**SOCKEL32 KLEB**

En cas de dommage, veuillez retourner le carton avec le produit. En cas de dommage, veuillez retourner le carton avec le produit.



OBEREN 5 30/19 HAUT 23.08.19 OBEREN 1 1. JABOVE OBEREN



**WIMEX Wohnbedarf**  
Import Export Handelsges mbH & Co. KG  
Werner-von-Siemens-Str. 35  
D-49124 Georgsmarienhütte - Germany

**SAMPLE**    **23.08.19**  
Modellname    Produktionsdatum  
Model    Date of manufacture

