

A	B	C (mm)			D
1	L30-001	2040	450	19	5/5
2	L30-002	2040	450	19	5/5
3	L30-003	2040	450	19	5/5
4	L30-004	2040	450	19	5/5
5	L30-005	2040	450	19	5/5
6	L30-101	2080	585	36	1/5
7	L30-102	2080	585	36	1/5
8	L30-103	2044	556	16	2/5
9	L30-104	2044	556	16	2/5
10	L30-201	2406	615	36	3/5
11	L30-301	2274	556	36	3/5
12	L30-302	902	535	22	4/5
13	L30-304	438	535	16	4/5
14	L30-305	437	535	16	4/5
15	L30-401	2274	40	16	3/5
16	L30-901-01	2054	910	2,5	1/5
17	L30-902	2054	446	2,5	1/5
18	L30-903-01	2054	910	2,5	1/5
19	dr-897	897	30	15	4/5

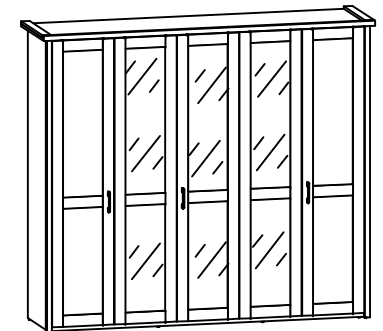

4x a101	6x a103	4x a43	6x a68	cm 0 1 2 3 4 5 6 7 8 9 10						10x b35	10x b59
3x 128 mm c406	12x Ø5x17 mm d1	4x Ø7x28 mm e22	16x Ø8x30 mm f1	6x M4x25 mm j8	8x k1	2x M6/Ø14x14 mm k392	2x M6/22 mm k393	58x l2	4x n158	4x Ø3,5x13 mm p1	
40x Ø3,5x15 mm p51	24x Ø15x12 mm #16 r1	18x Ø20x12 mm #16 r36	18x r37	24x r42	1x z1	4x s1	24x Ø16 s2	5x d20	5x Ø6,3x13 mm e2	8x Ø5x17 mm d1	



1 §2

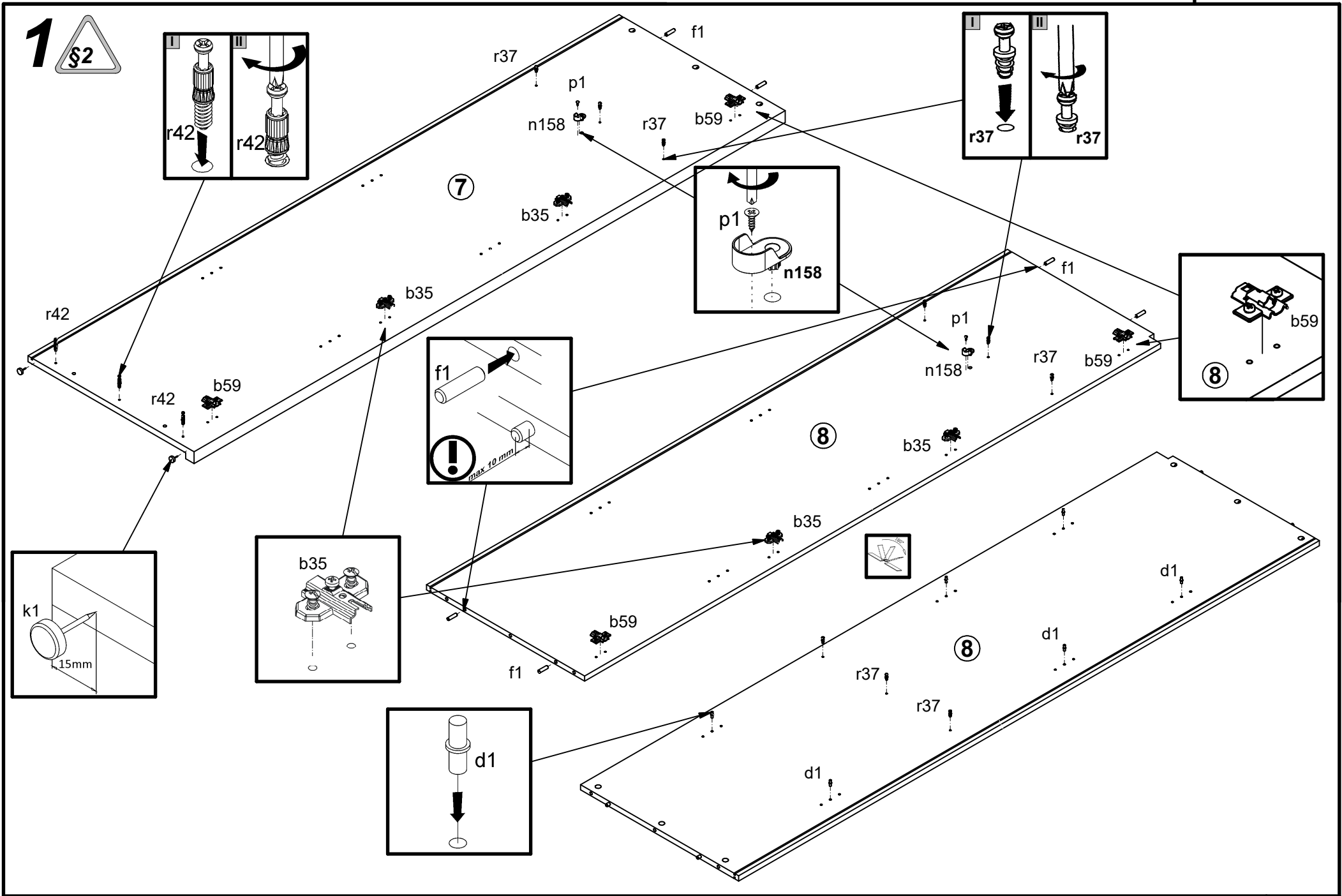
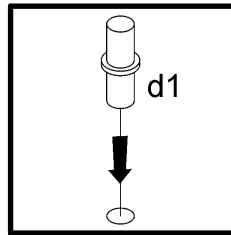
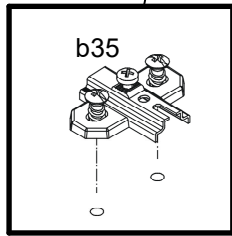
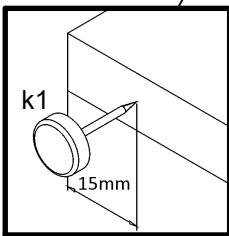
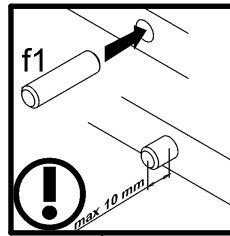
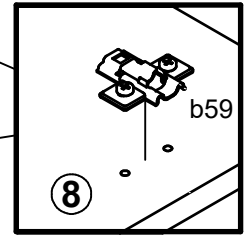
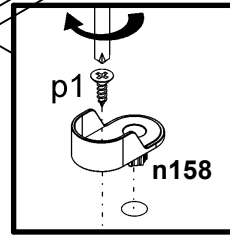
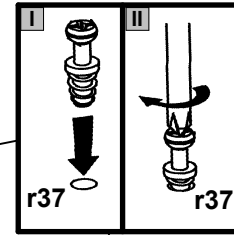
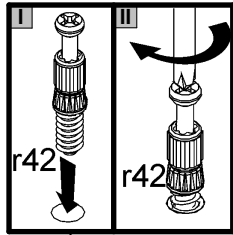

2

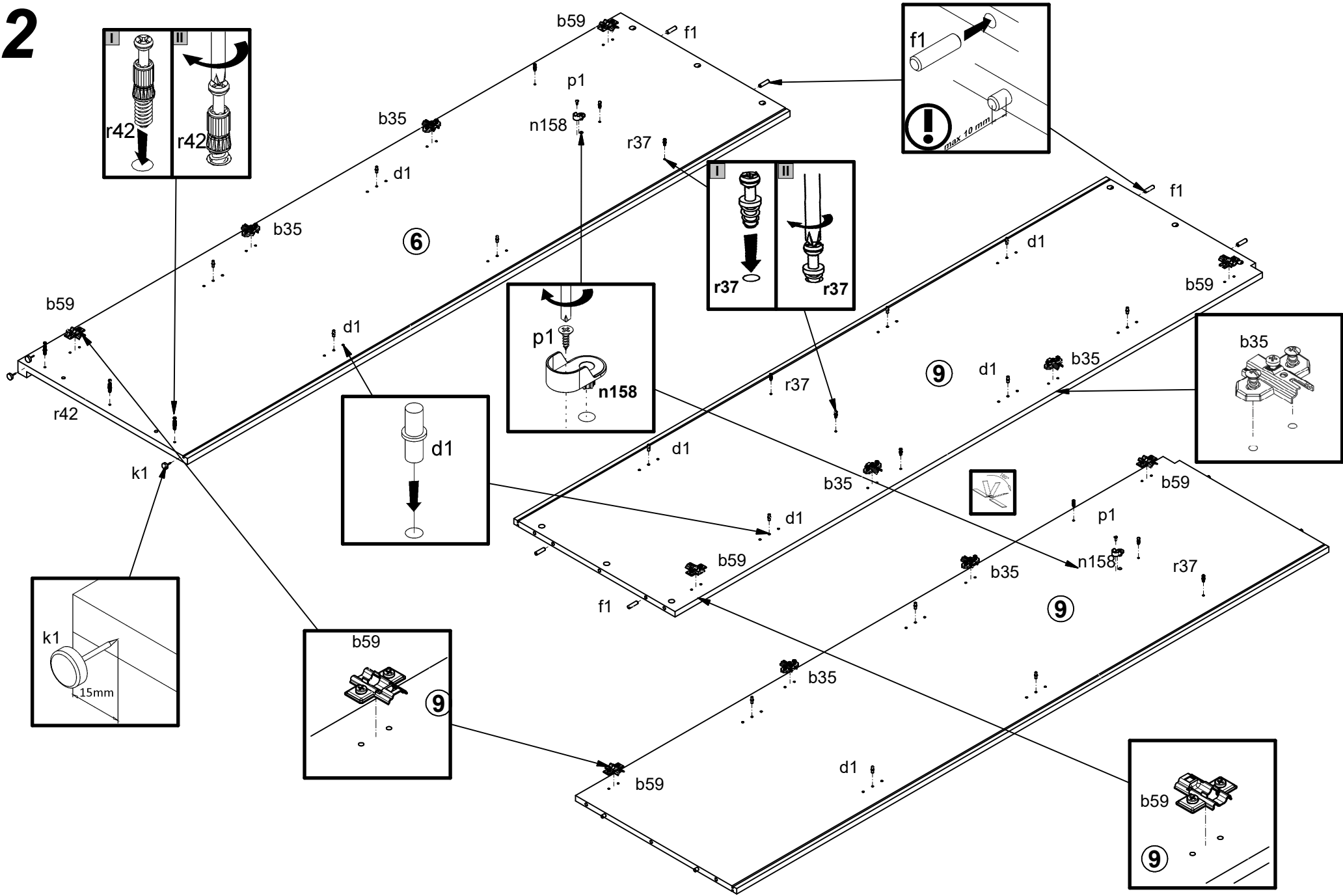

3

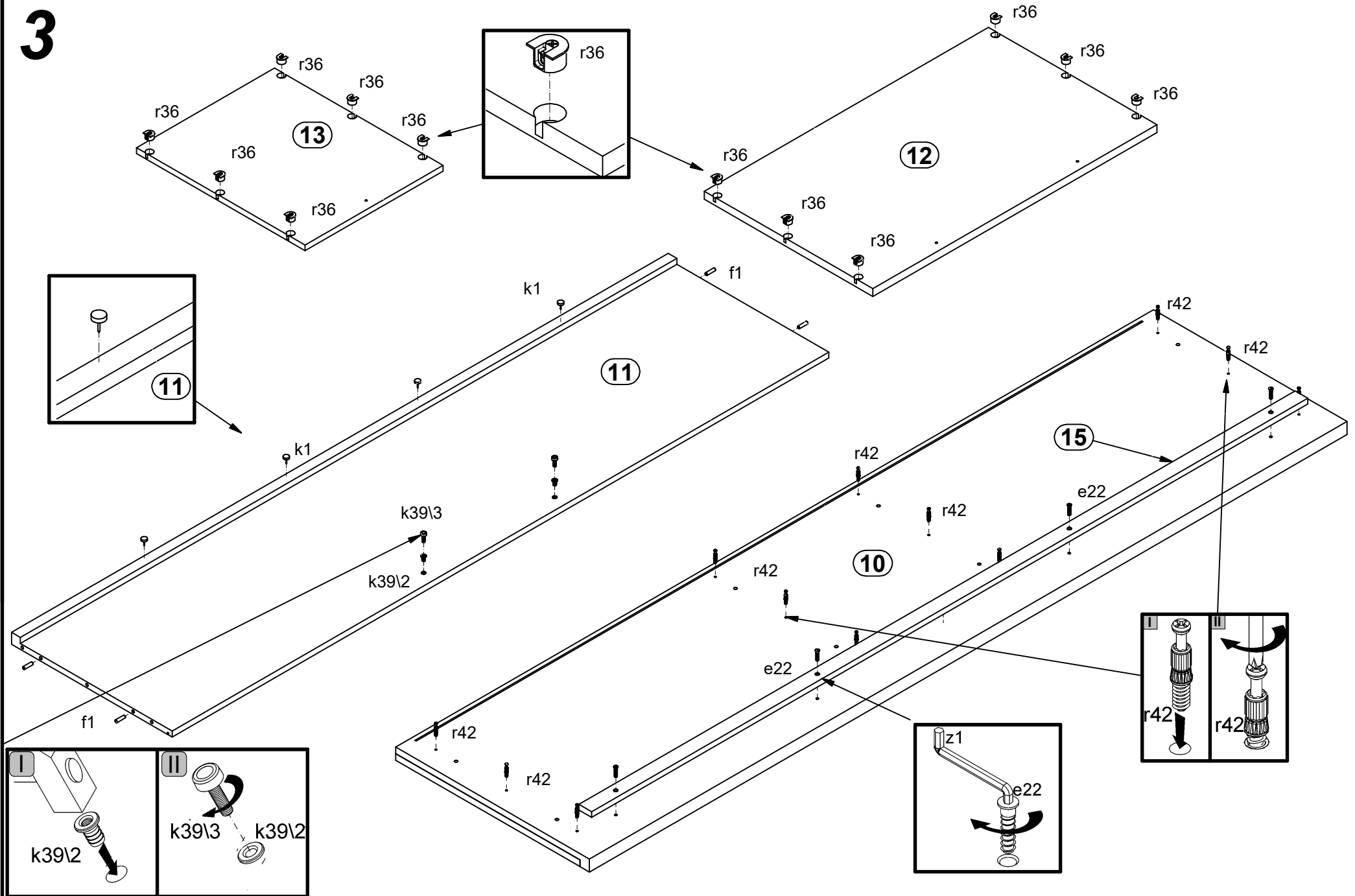

4  

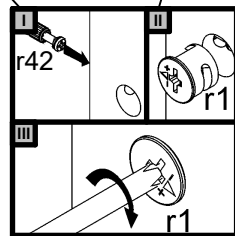
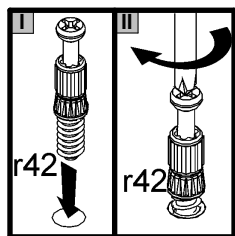
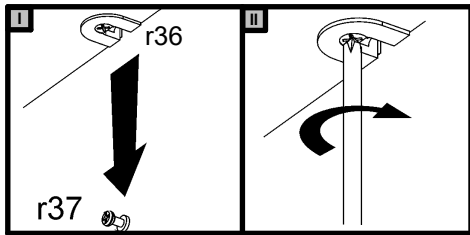
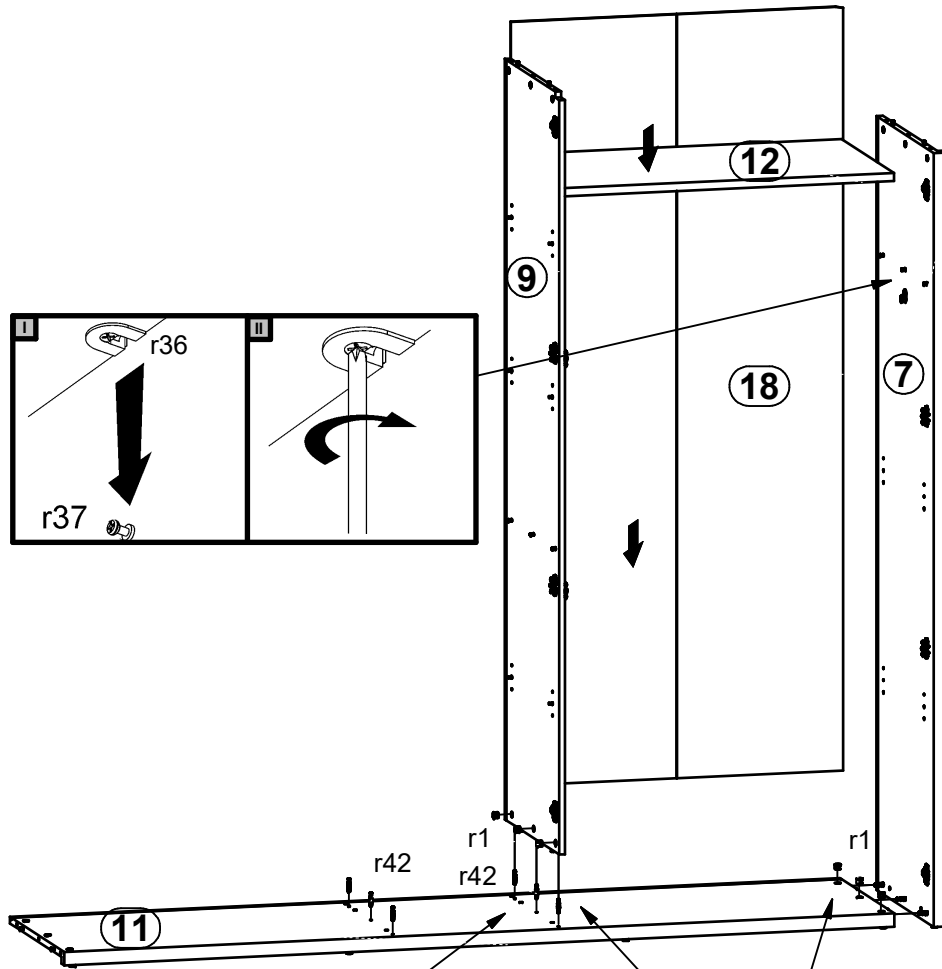

5 

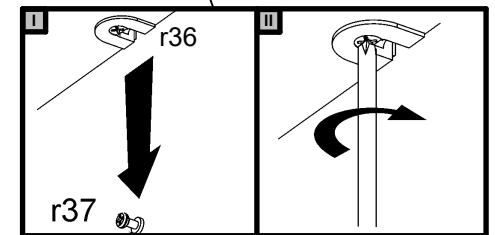
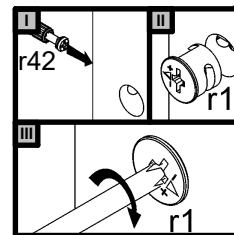
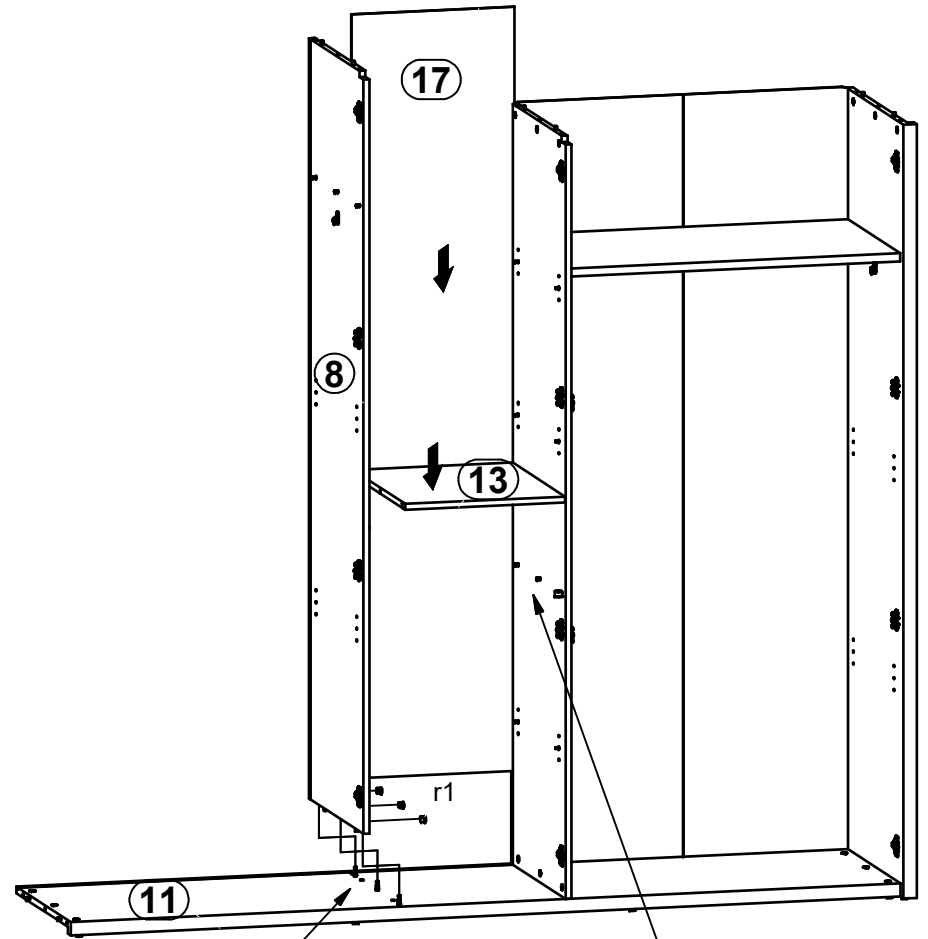

6

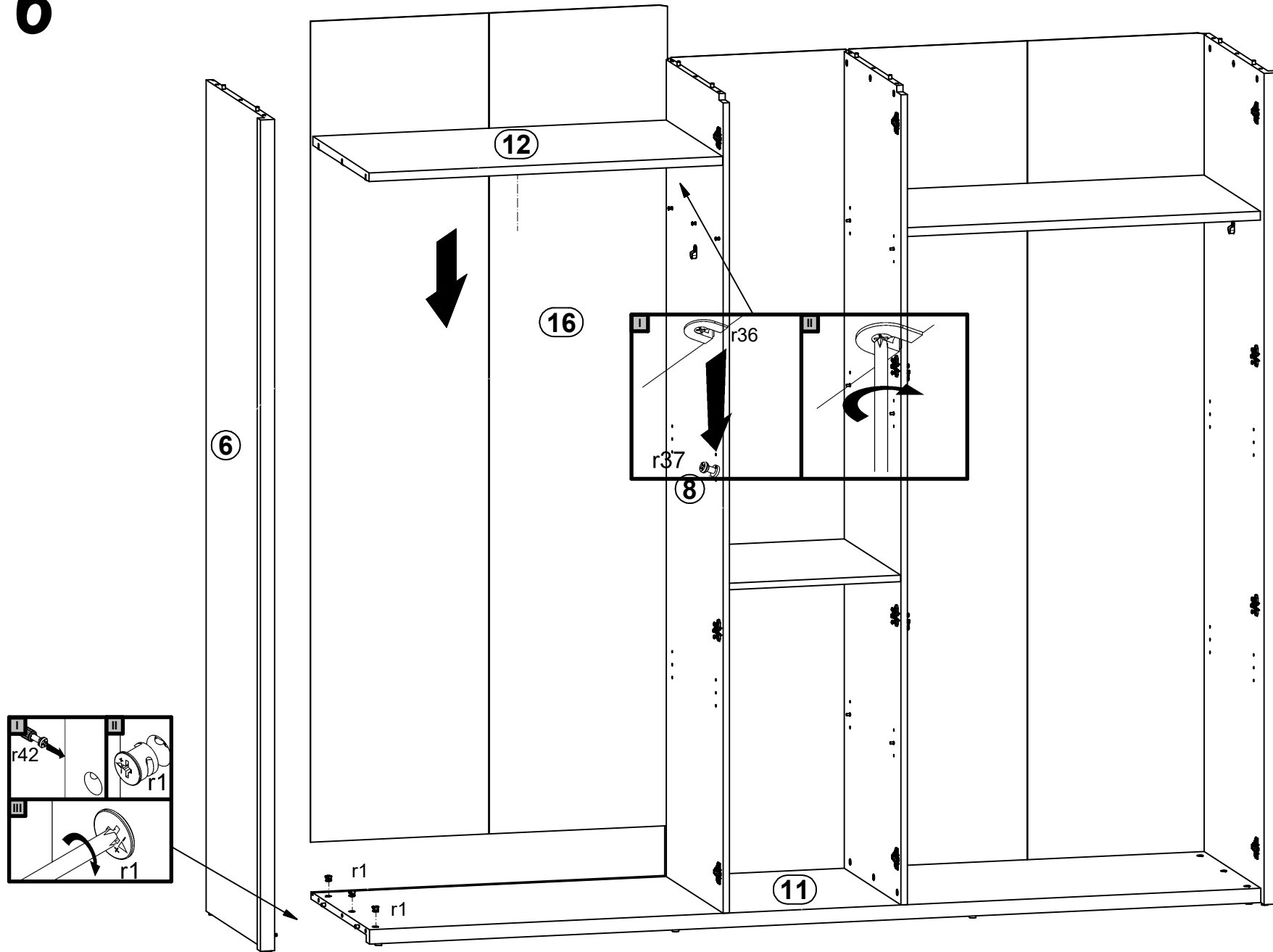

7

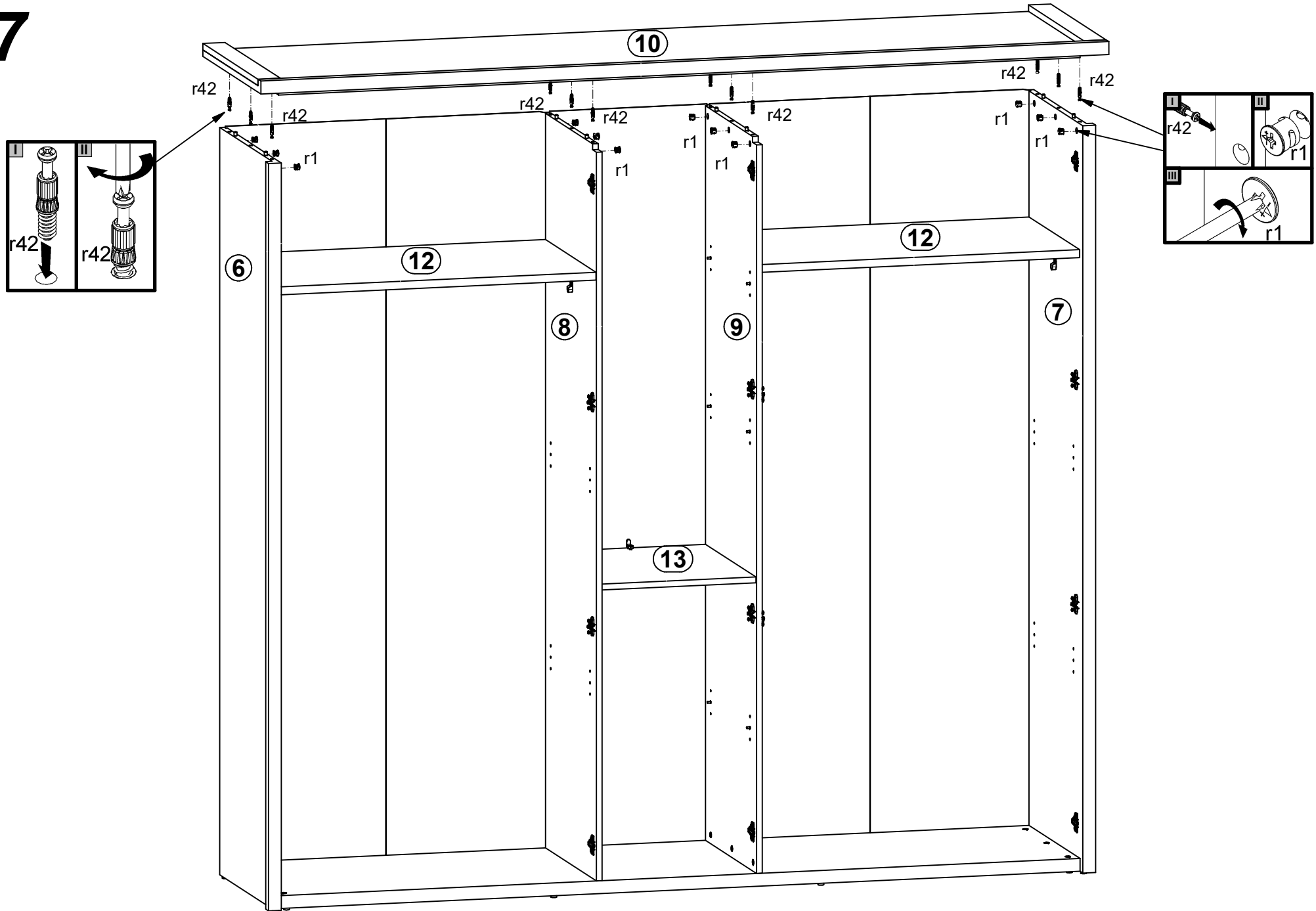

8

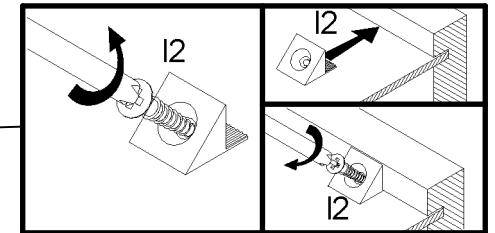
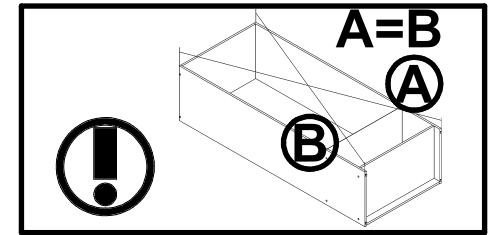
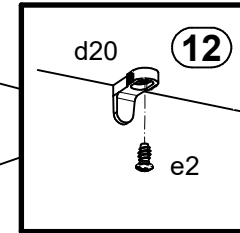
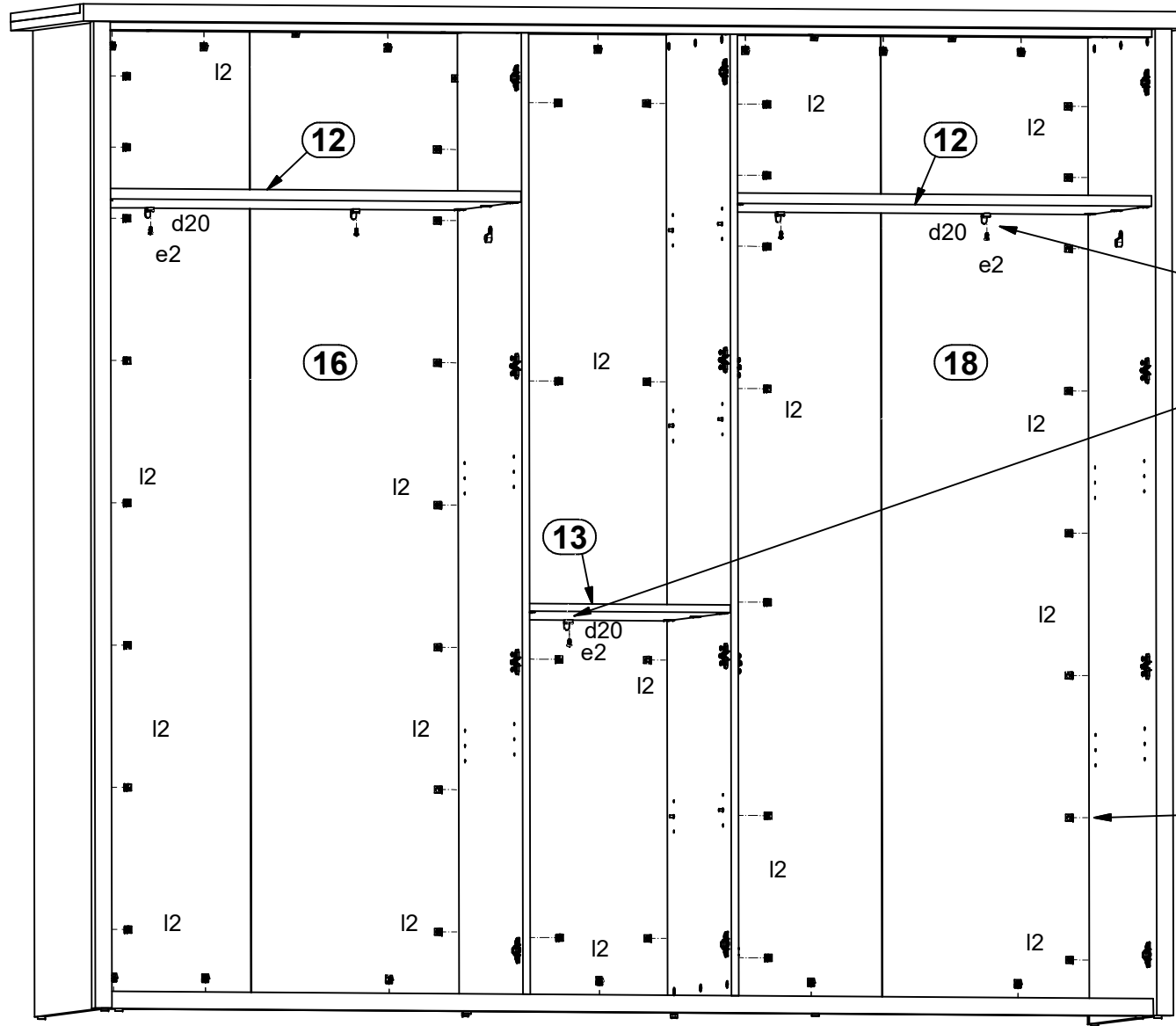

9

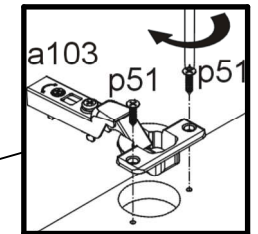
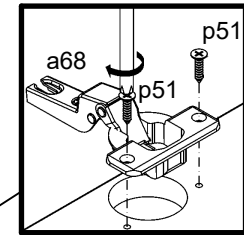
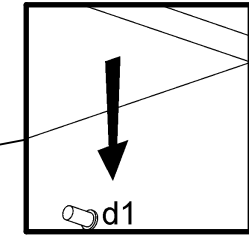
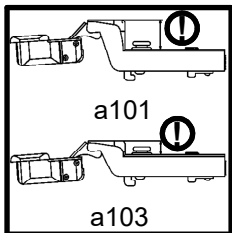
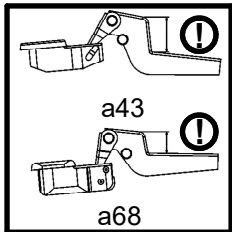
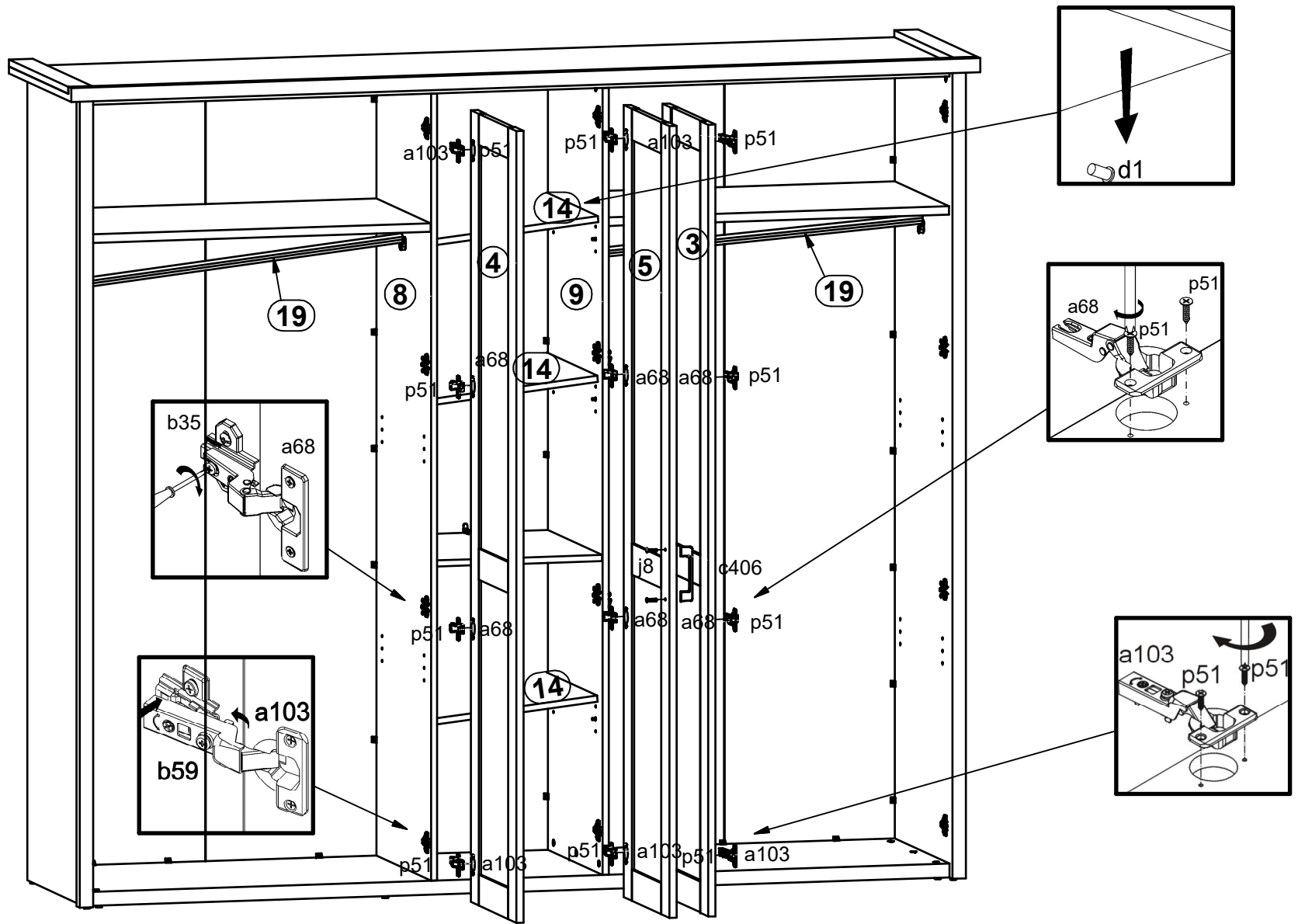

10

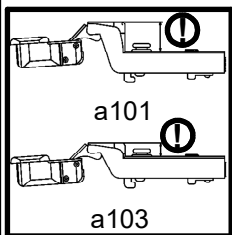
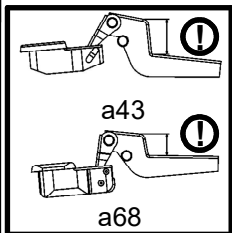
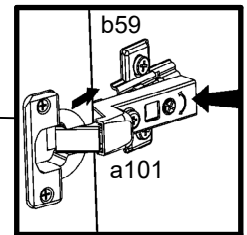
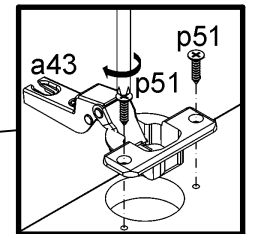
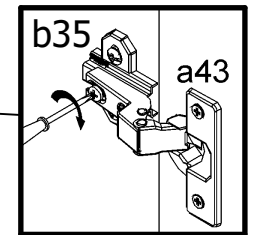
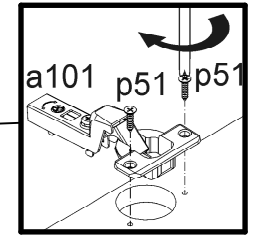
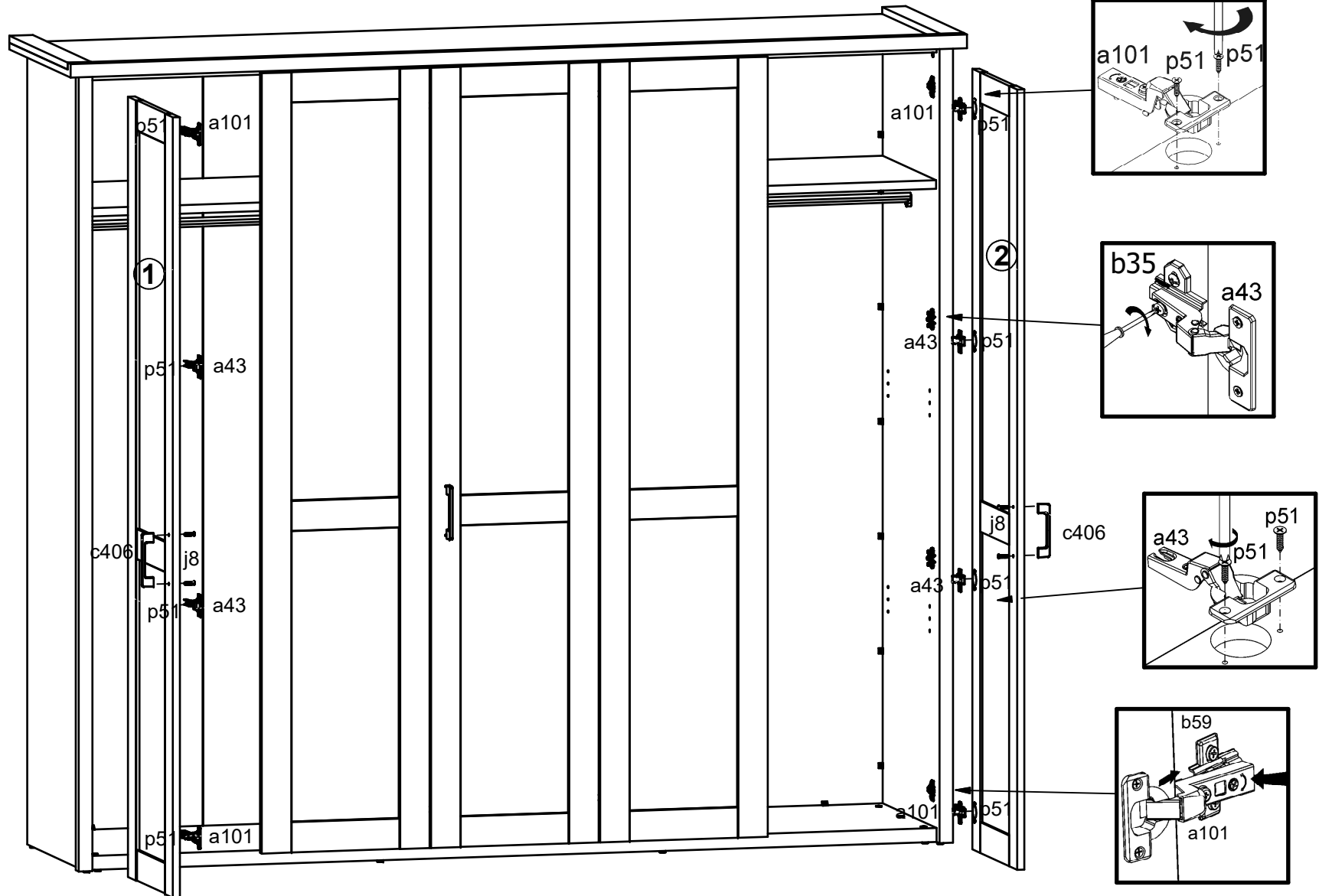

11

