

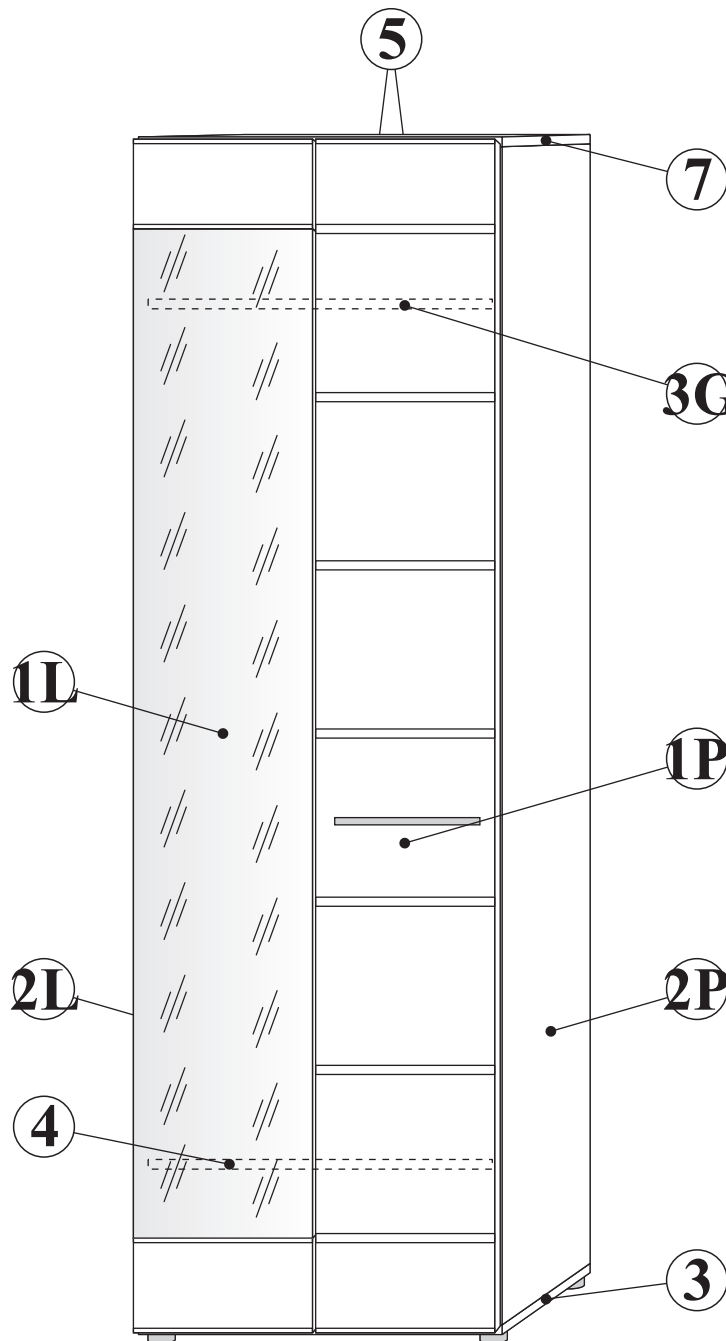

60 min.

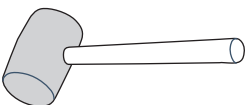

- | | |
|------------|------------------------|
| A1 | $\phi 8 \times 36$ x12 |
| C6 | L-260 x1 |
| B5 | x4 |
| UP9 | 3x16 x4 |
| B4 | x4 |
| G8 | L-1946 x1 |
| G5 | #15 x4 |
| UL | L-224 x1 |
| B11 | 7x50 x8 |
| UP6 | 4x30 x2 |
| I1 | $\phi 2$ x8 |
| D11 | 3.5x25 x4 |
| G7 | x4 |
| I11 | x4 |
| S1 | x14 |
| E1 | Kr0 x6 |
| L1 | x1 |
| D10 | 3.5x13 x14 |
| KR2 | x1 |
| E2 | H0 x6 |
| D22 | 4x40 x1 |
| EK2 | 6,3x13 x12 |
| G2 | S-4 x1 |

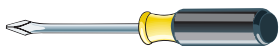
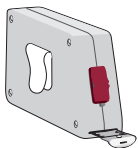
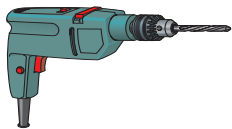
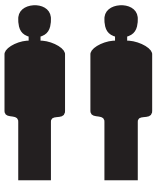
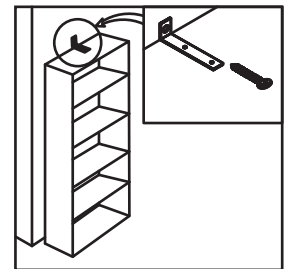
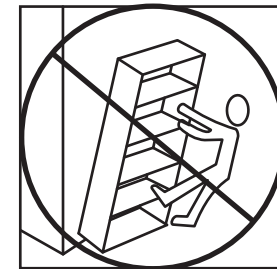
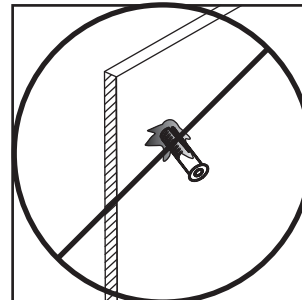
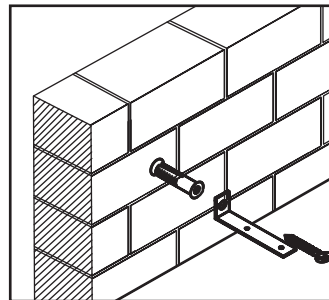
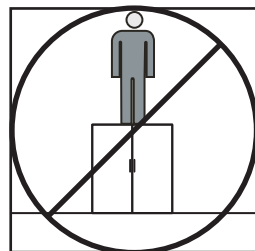
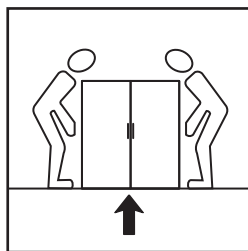
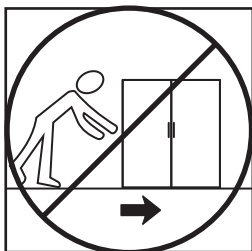
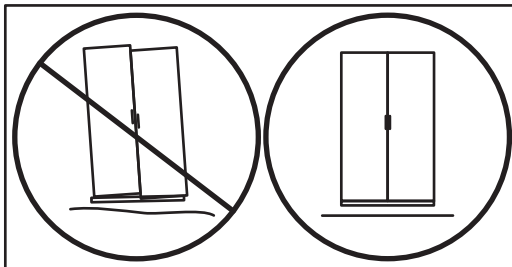
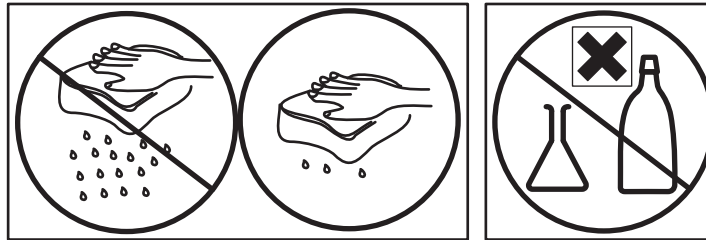
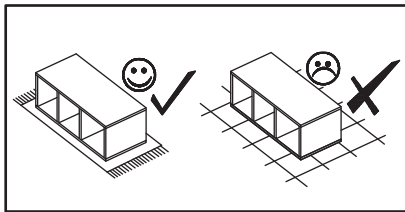
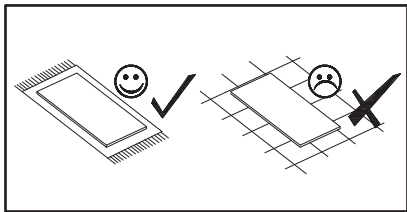
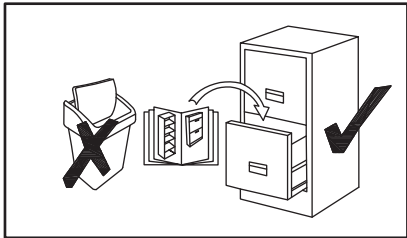
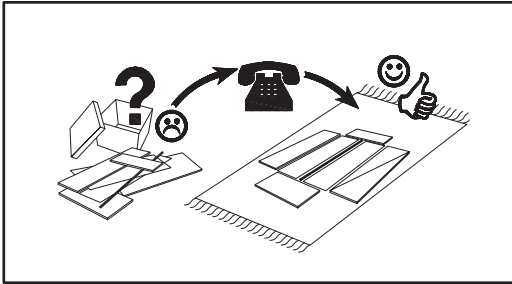

1

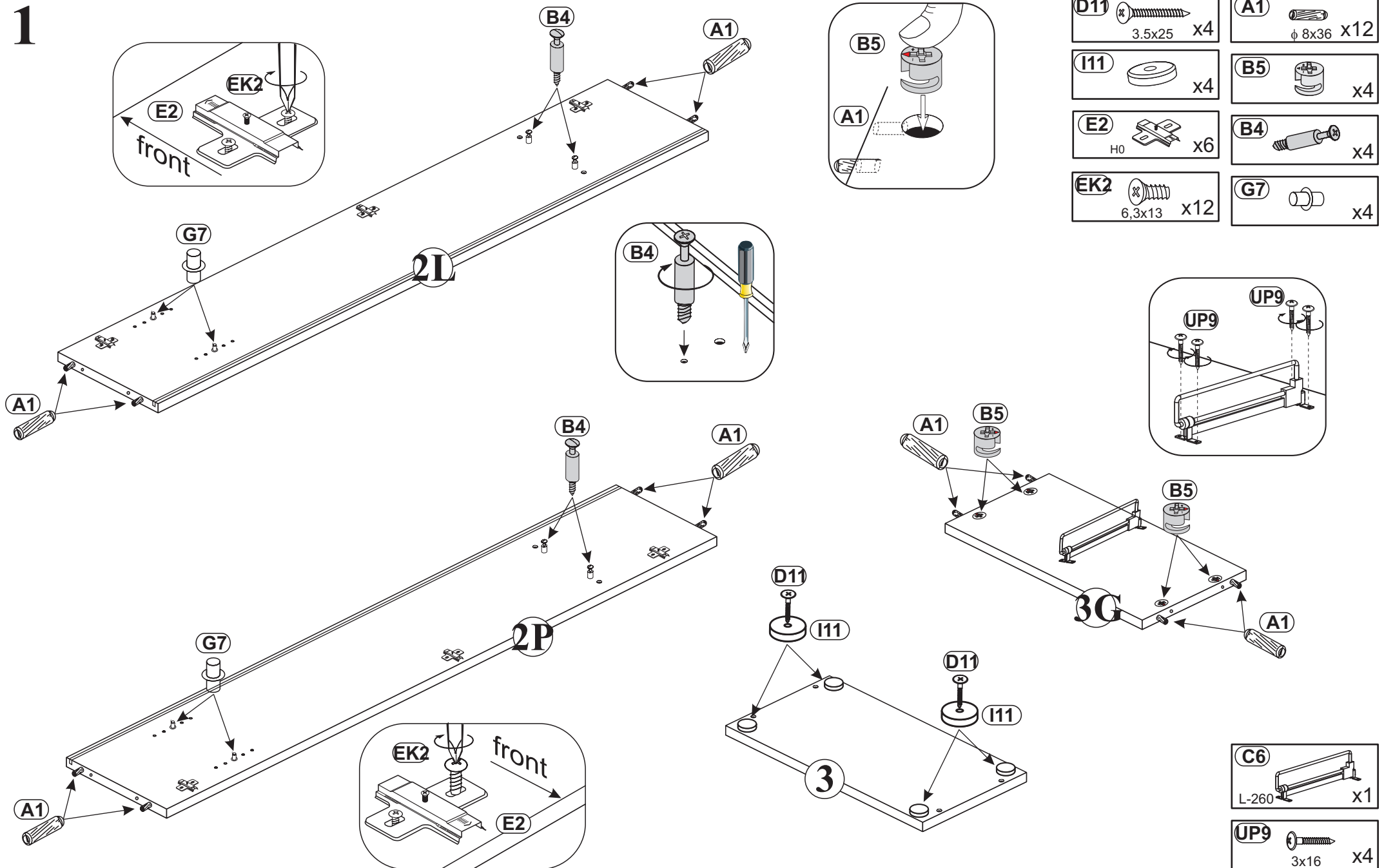

2

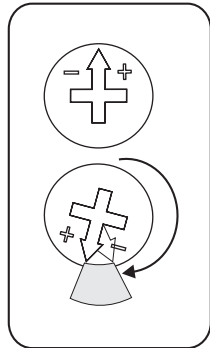
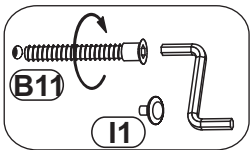
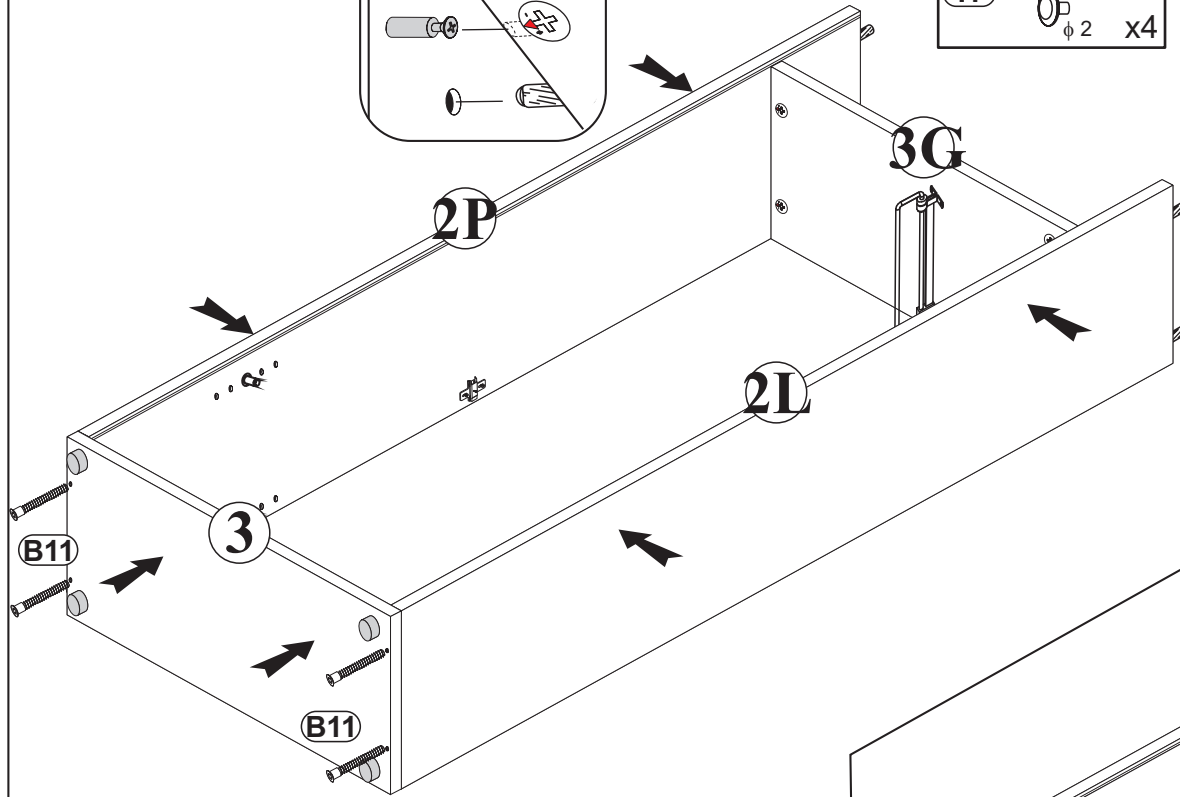
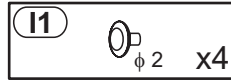
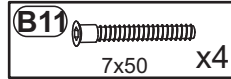
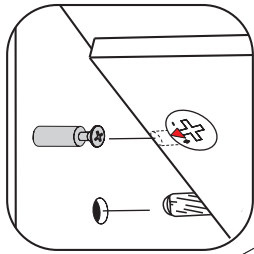

3

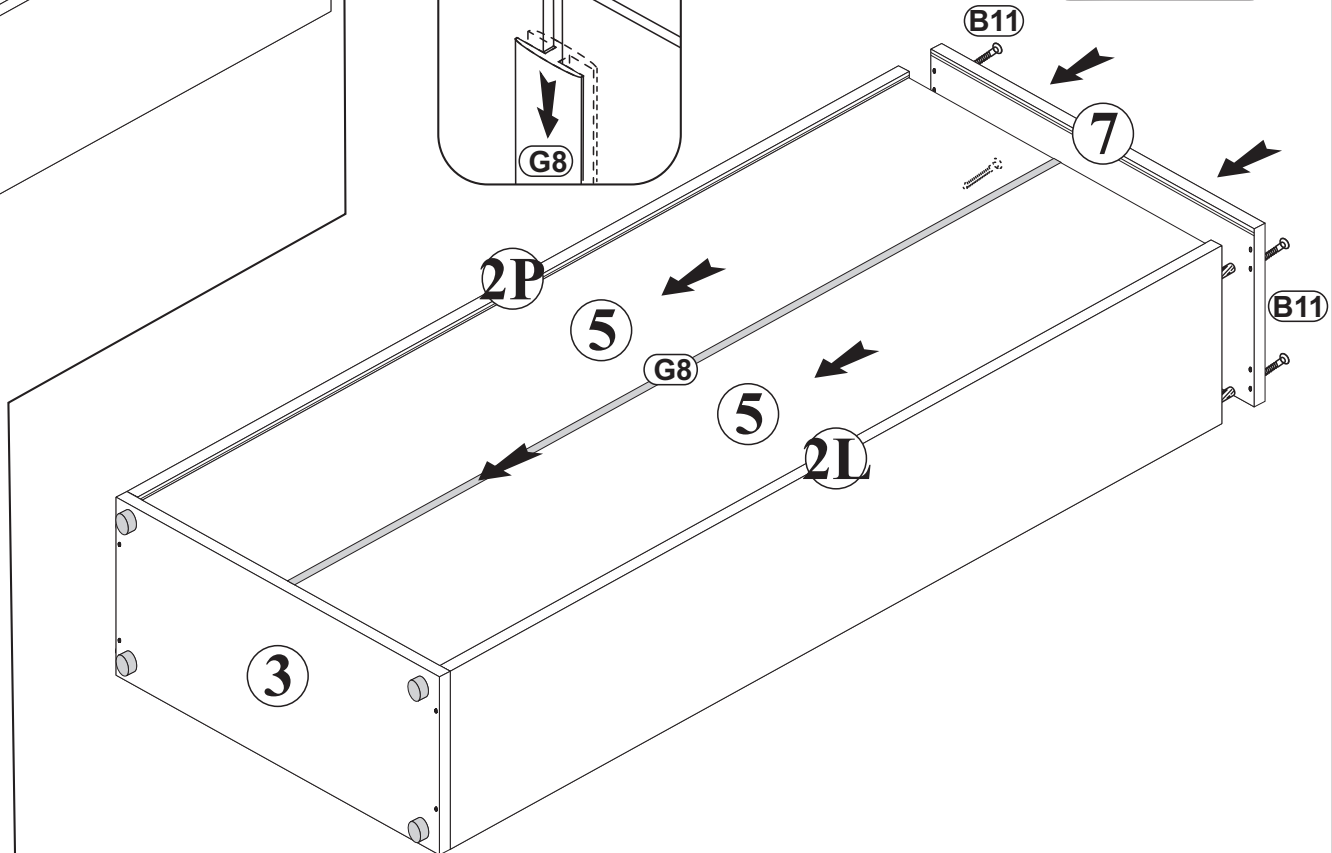
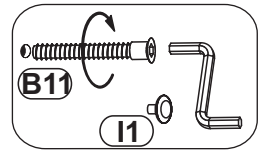
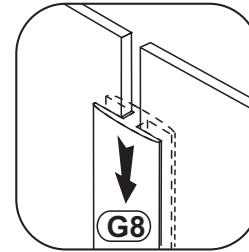
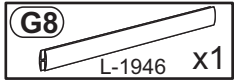
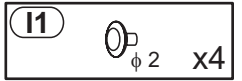
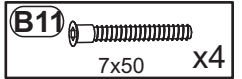

4

S1  x14

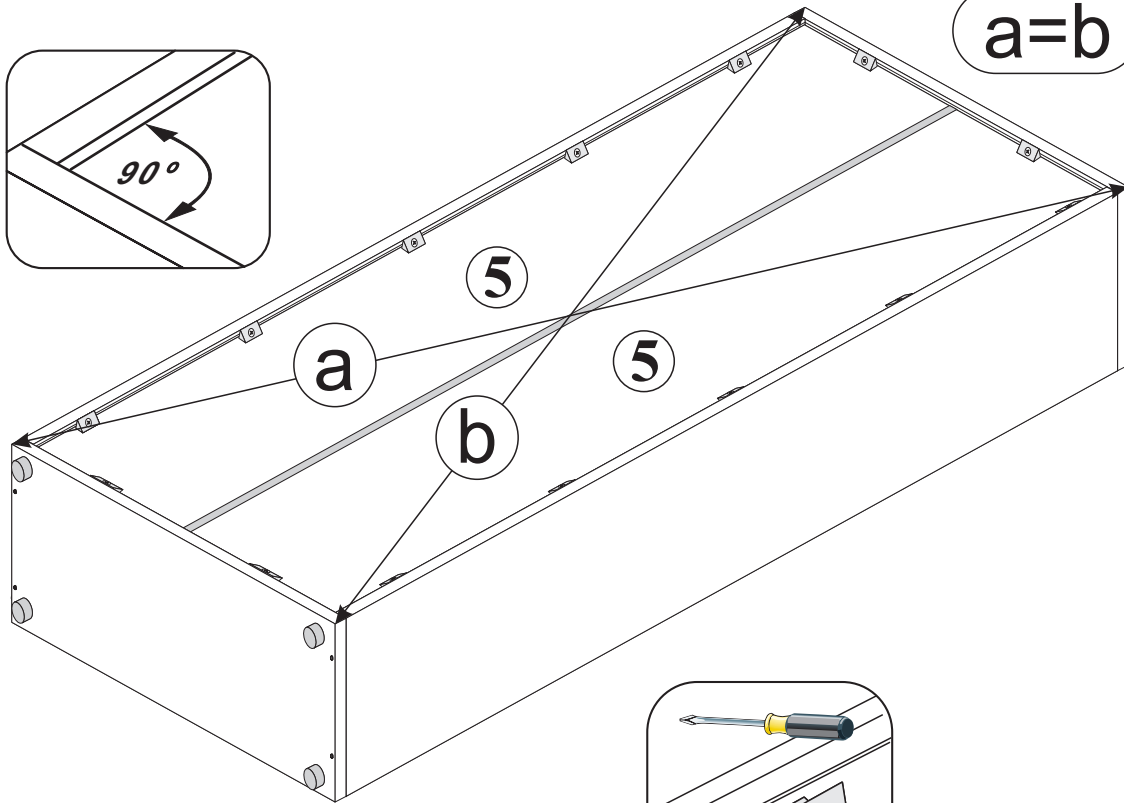
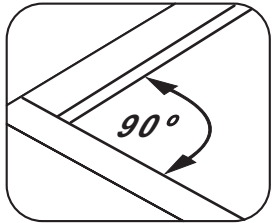

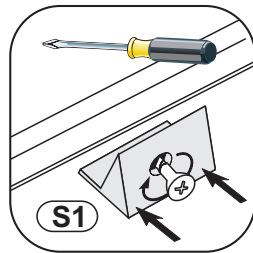

a=b



5

UL  L-224 x1

E1  Kr0 x6

UP6  4x30 x2

D10  3,5x13 x12

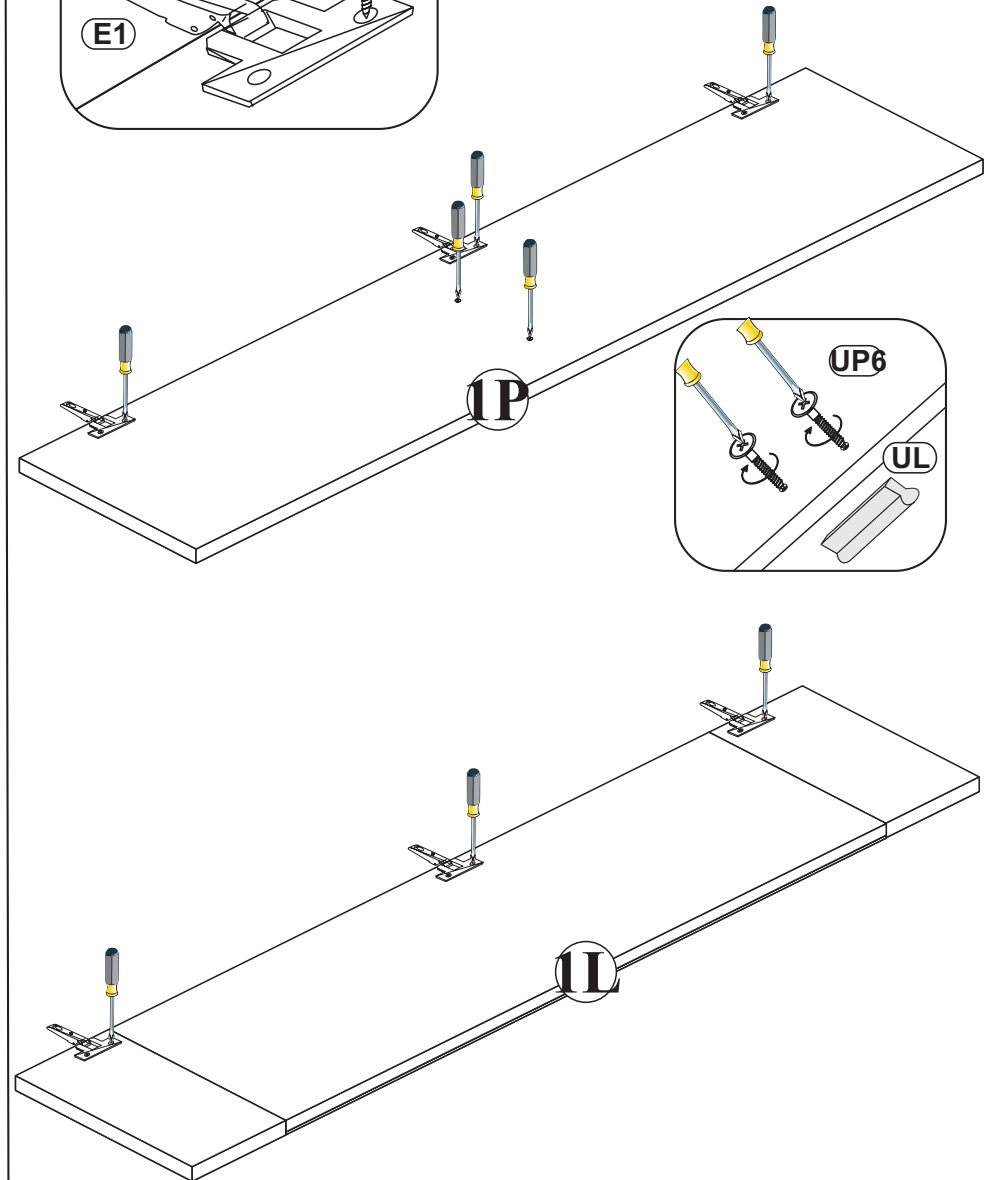
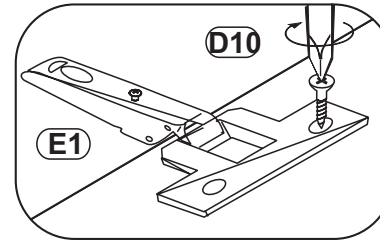

6

G5 #15 x4

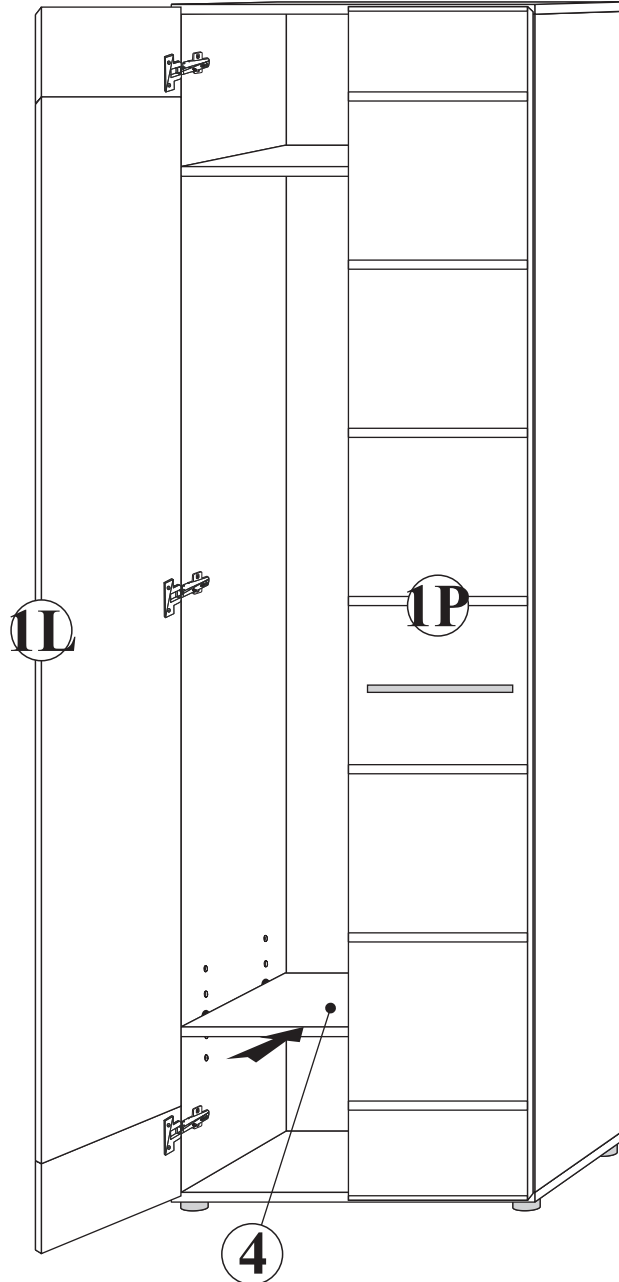
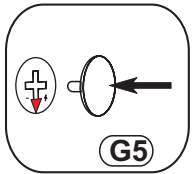
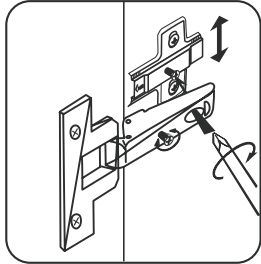

7

D22 4x40 x1

D10 3,5x13 x2

L1 x1

KR2 x1

