

Sabine

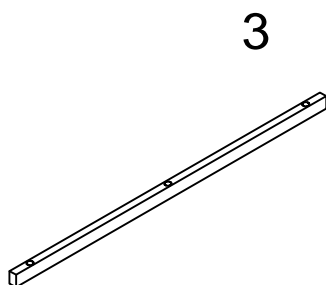
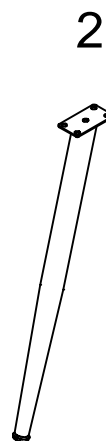
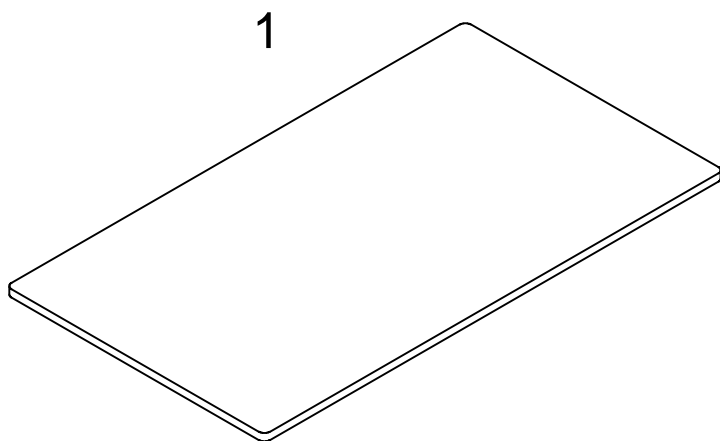
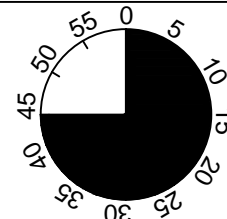
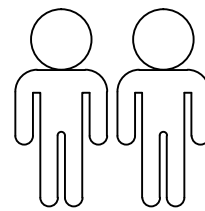
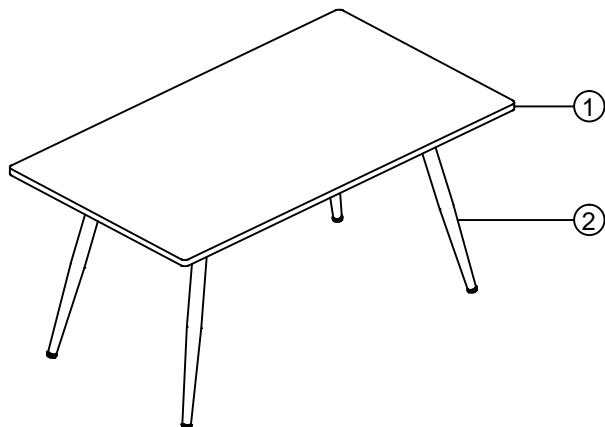

1	1X	1/2
2	4X	2/2
3	2X	2/2

A	M6X35 6x	B	M8x16 16x	C	Ø18xØ8x1.5 16x	D	Ø18xØ6x2.5 2x	E	M8x12 16x	F	M6x12 6x
G	5MM 1x	H	6MM 1x	I	8MM 1x						

I.

1

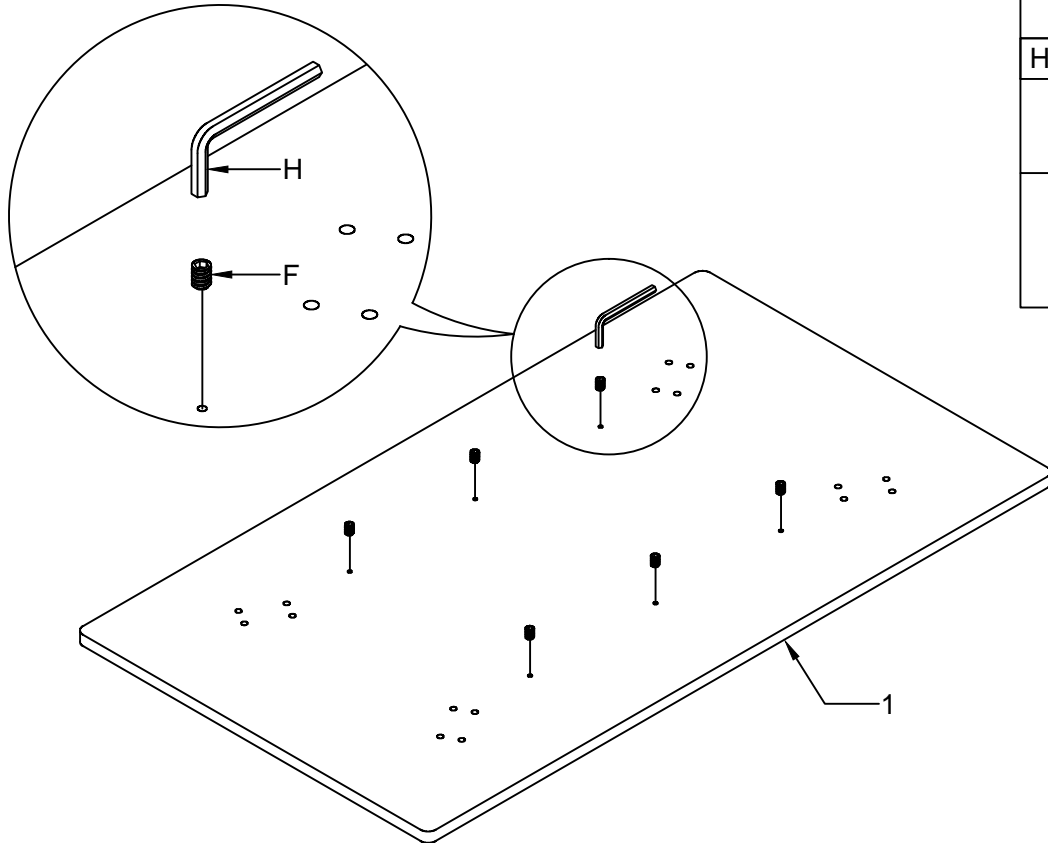

F	M6x12
	6x
H	6MM
	1x

2

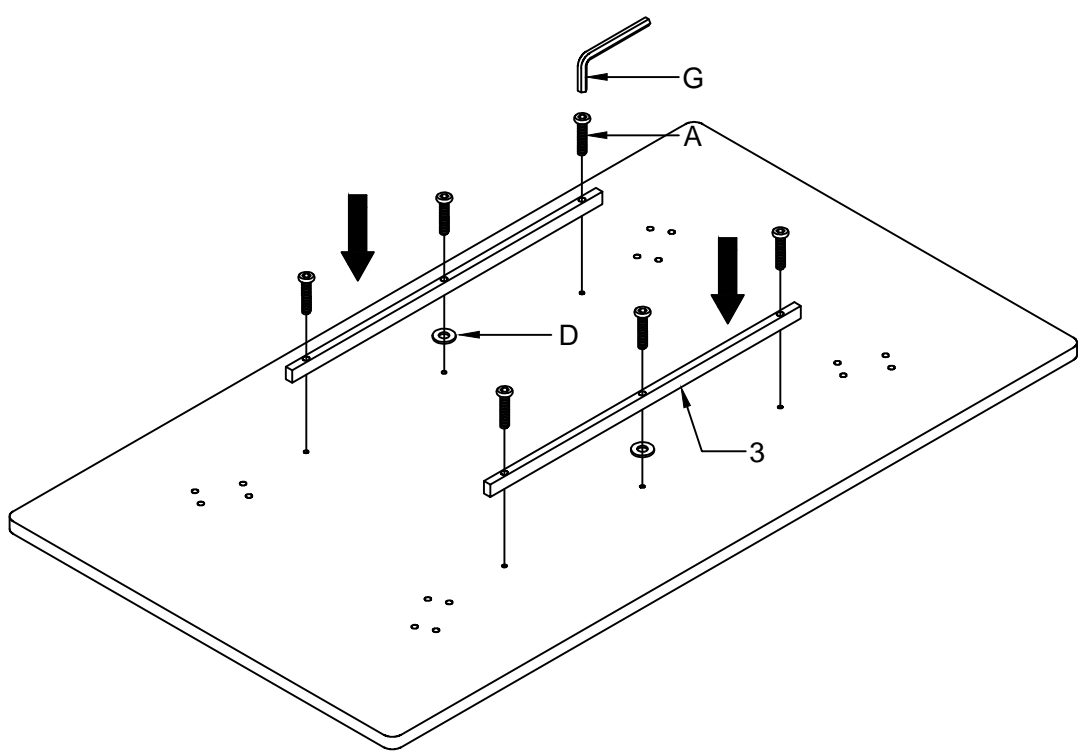



D	Ø18xØ6x2.5	A	M6x35
	2x		6x
		G	5MM
			1x

II.

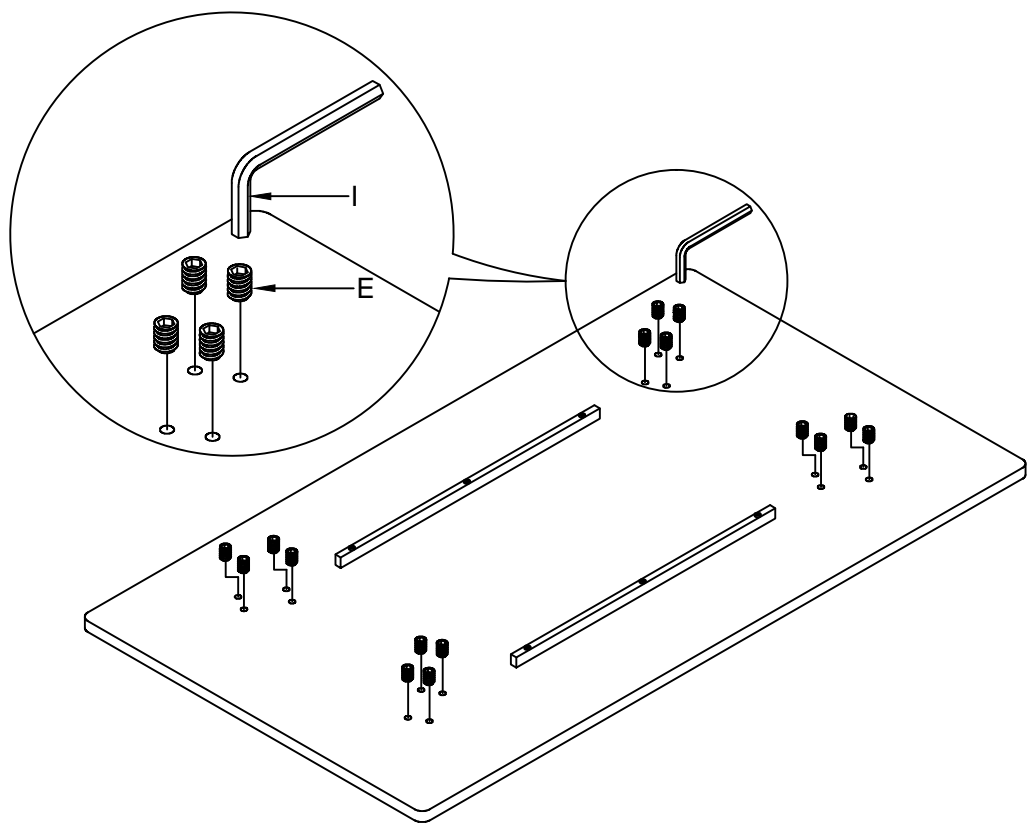

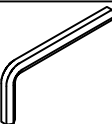
3

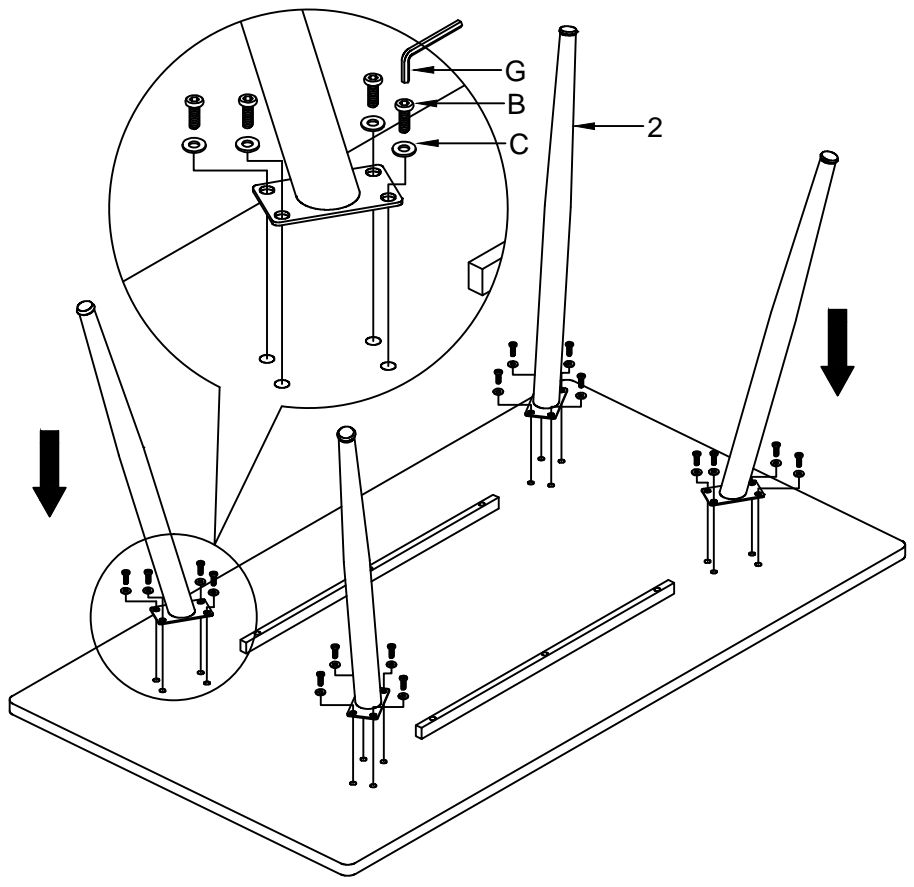

E	M8x12
	16x
I	8MM
	1x
	

4

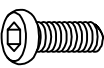

B	M8x16
	16x
C	Ø18xØ8x1.5
	16x
G	5MM
	1x
