

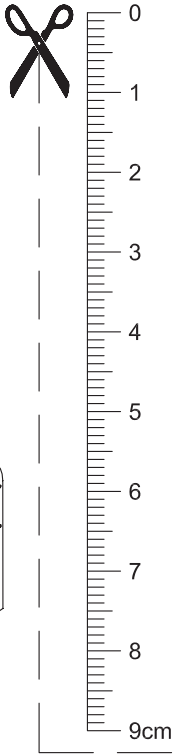









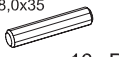
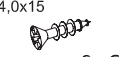

**Montageanleitung**  
 Instructions de montage  
 Istruzioni di montaggio  
 Assembly instructions  
 Instrucciones de montaje

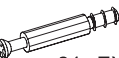
**PEDRO 4**

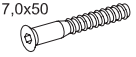

Beschläge / Ferrures /  
 Guarnizioni /  
 Fittings / Herrajes

-  1x SW4
-  8,0x35  
16x RD
-  4,0x15  
8x SP
-  4x BKR
-  24x EXB
-  6x NG
-  4,0x35  
24x LKS
-  7,0x50  
8x VBS
-  8x ADK
-  4x BG
-  24x EX
-  4,0x30  
8x GS

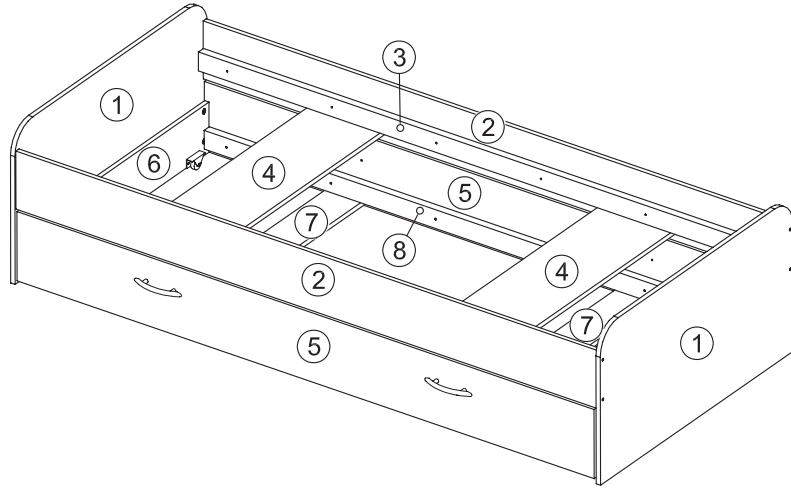

Art.-Nr. 800-004

Sie benötigen: Le servono:  
 Vous avez: You need:  
 besoin de: Necesita:

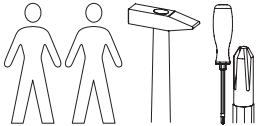

2 Pers.



**Achtung:** Bei mangelhafter Montage besteht Gefahr für die Sicherheit. Wir empfehlen die Montage nur durch fachkundiges Personal.

**Atención:** En caso de montaje incorrecto, existe peligro para la seguridad. Le recomendamos que el montaje lo efectúe únicamente personal especializado.



**Attention:** En cas de montage incorrect, il y a risque pour la sécurité. Nous recommandons de ne faire effectuer le montage que par du personnel qualifié.

**Warning:** Deficient assembly causes safety risks. We recommend having the assembly done only by qualified personnel.

**Attenzione:** Nel caso di montaggio non adeguato c'è pericolo di sicurezza. Consigliamo di far eseguire il montaggio esclusivamente da parte di personale esperto.





Teile / Pieces / Pezzi / Article / Piezas

		2x (8)		
		2x (3)		
		2x (5)		
		2x (2)		
	2x (6)			
	2x (7)			
	2x (4)			
			2x (1)	

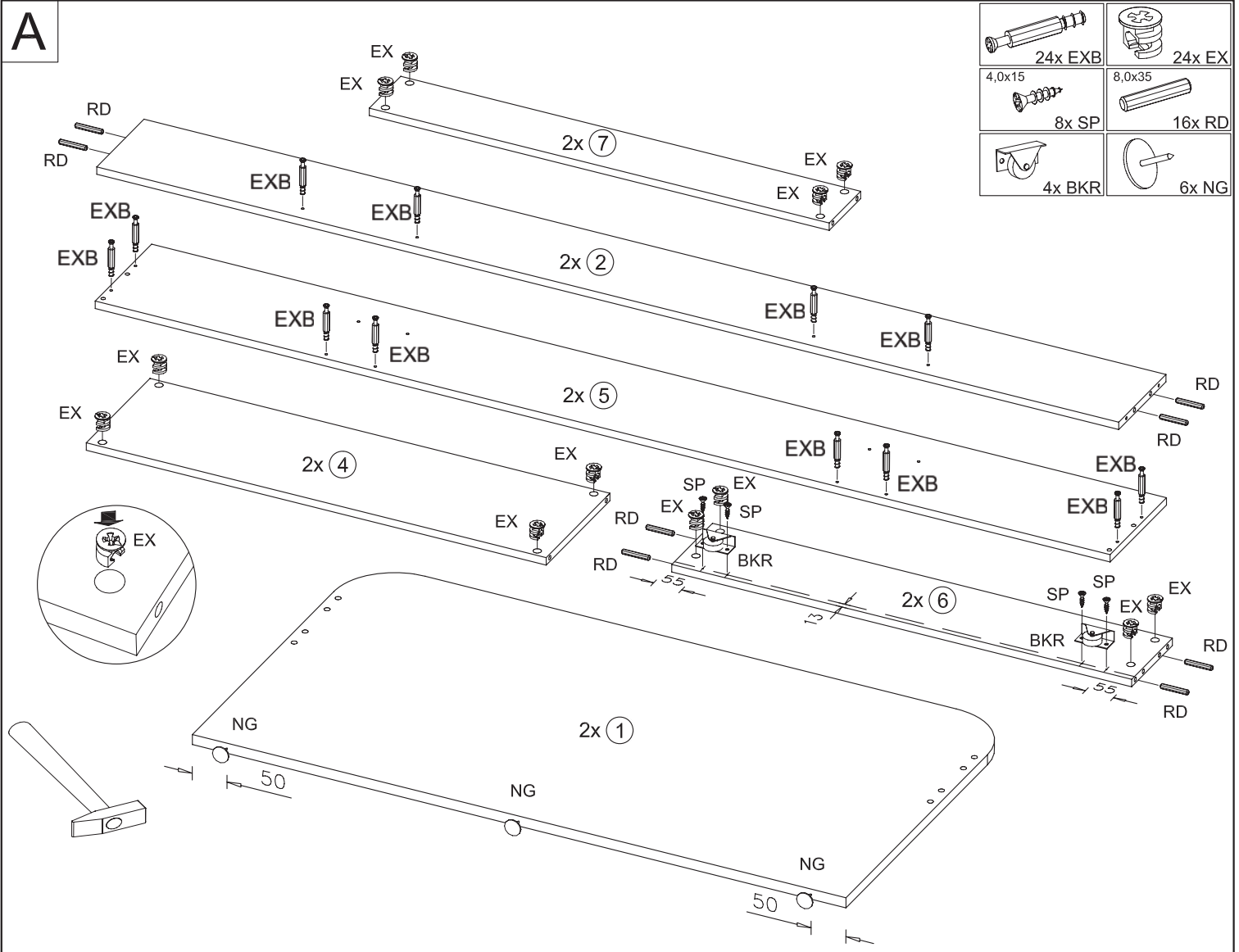

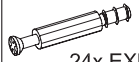
## A

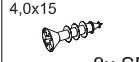
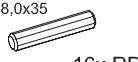

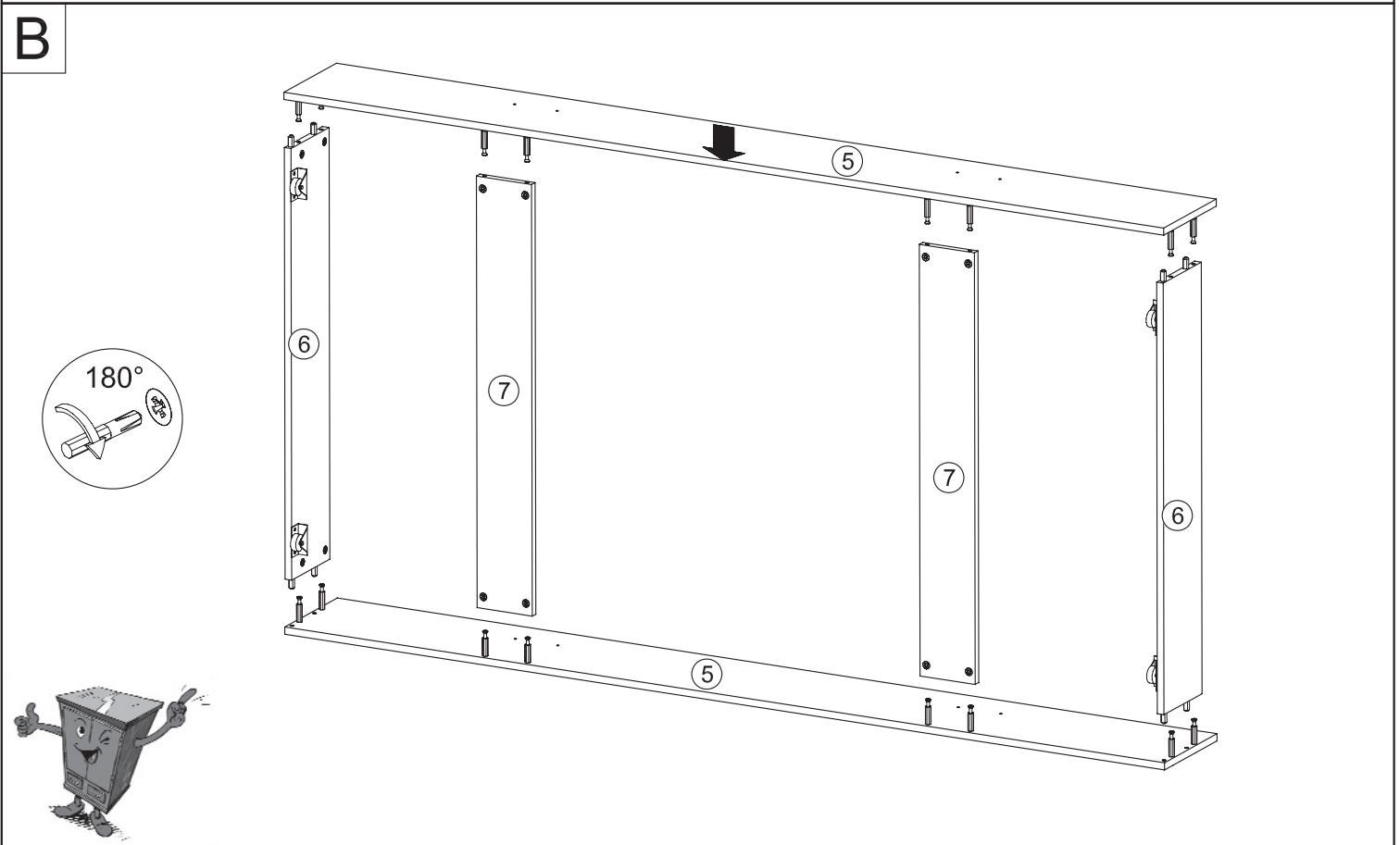

	
24x EXB	24x EX
	
4,0x15	8,0x35
8x SP	16x RD
	
4x BKR	6x NG

## B

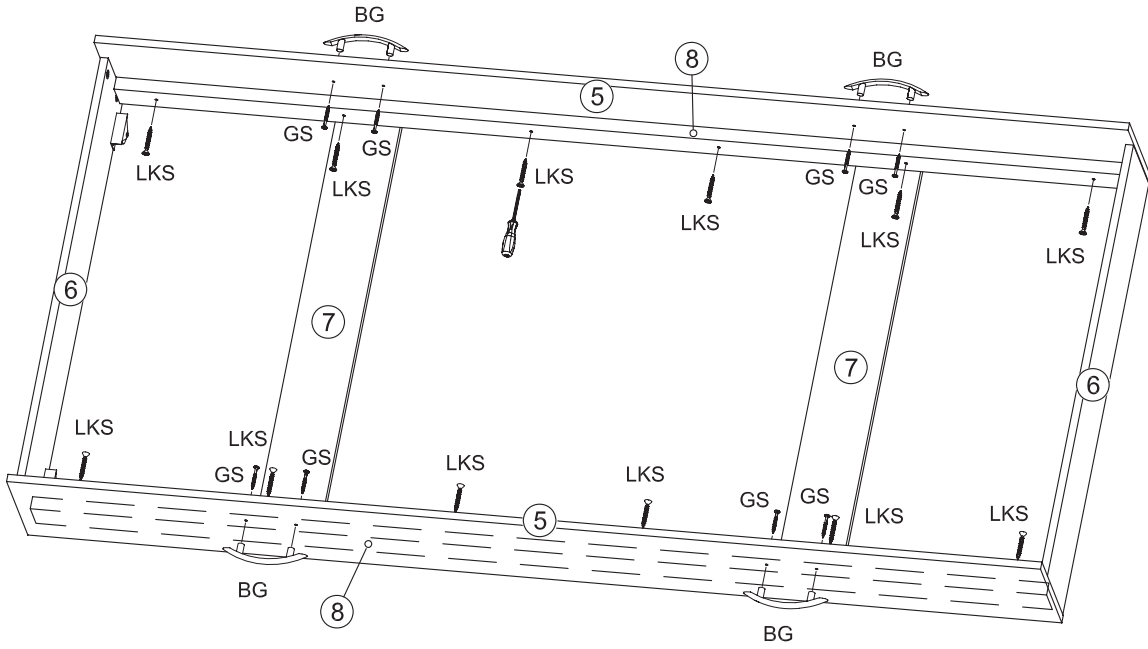

**C**

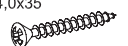

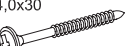
- 4,0x35  
 12x LKS
-  4x BG
- 4,0x30  
 8x GS

**D**

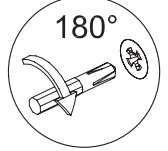
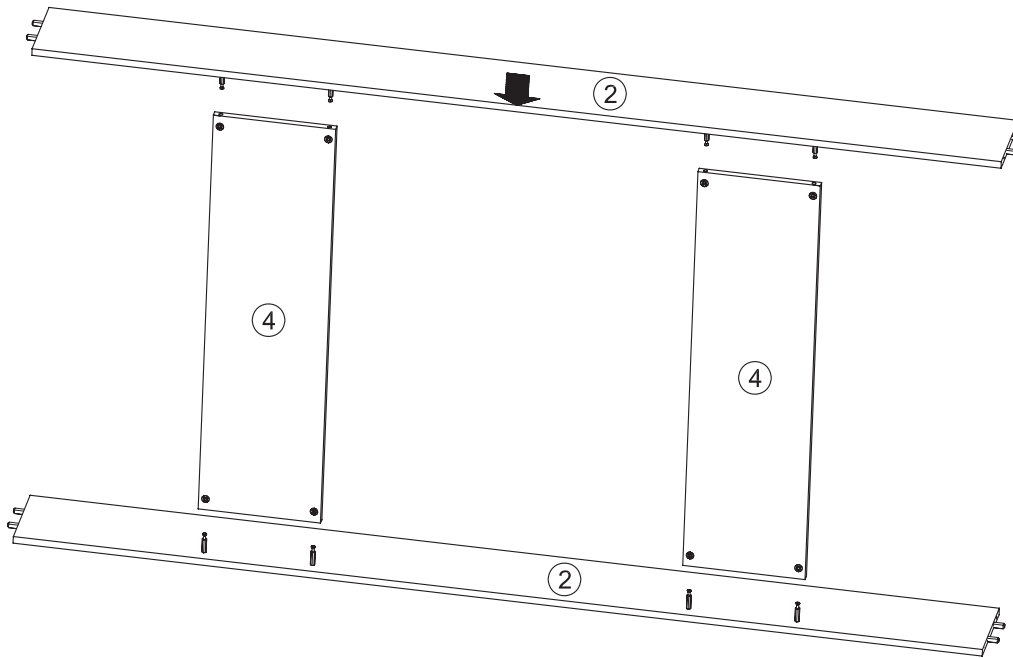

**E**

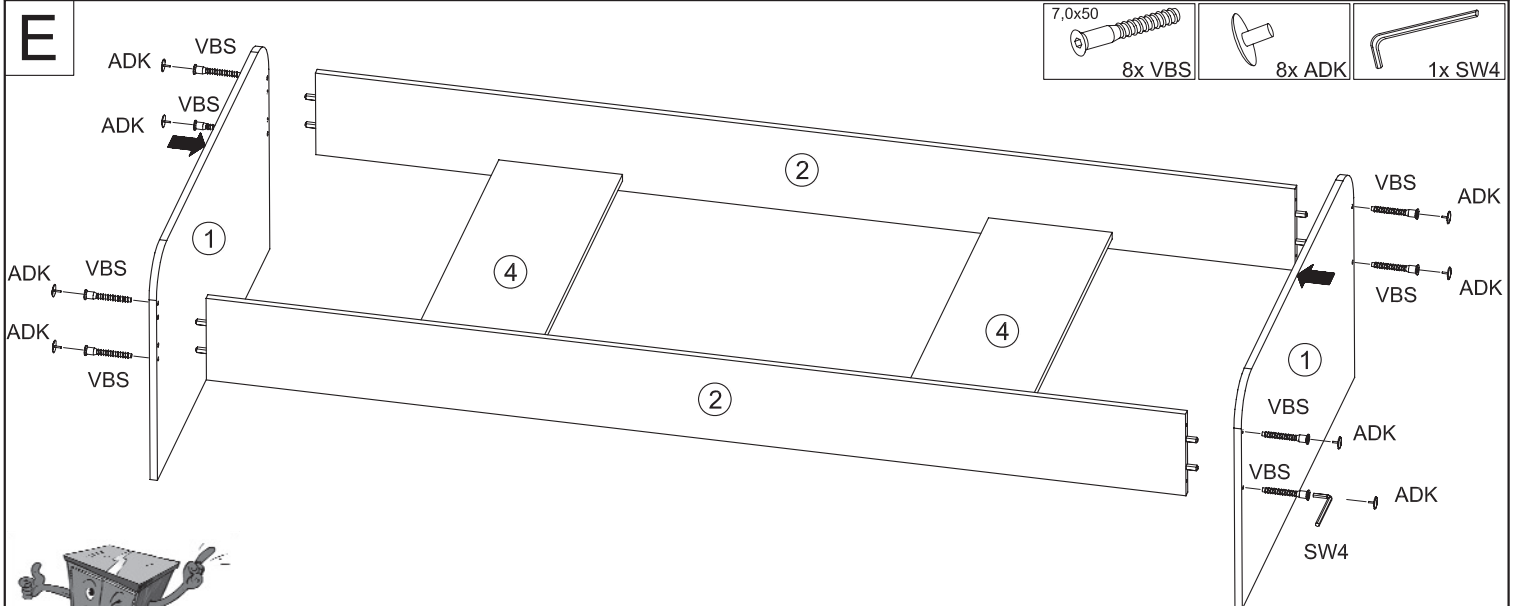

- 7,0x50  
 8x VBS
-  8x ADK
-  1x SW4



F

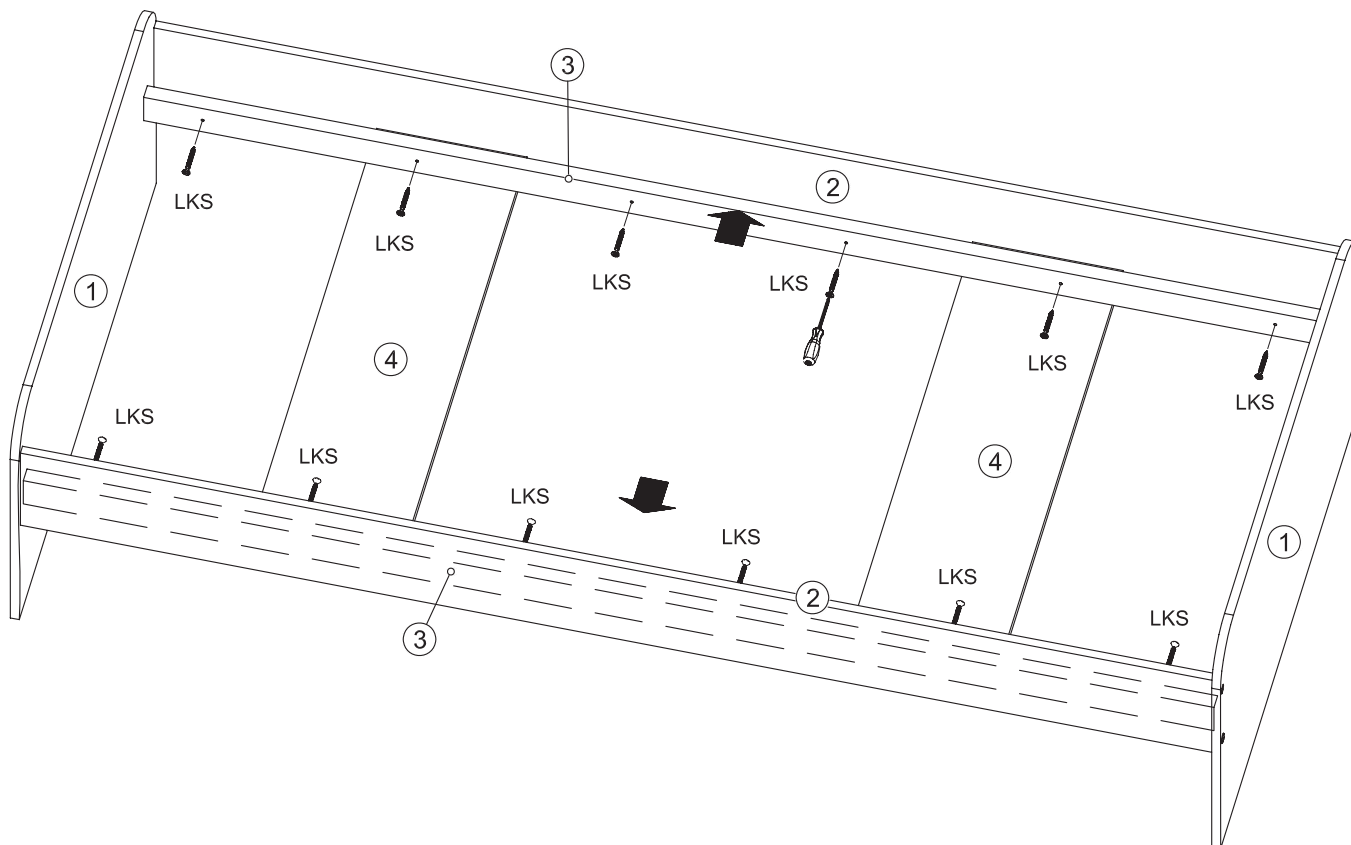
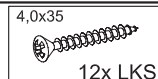

G

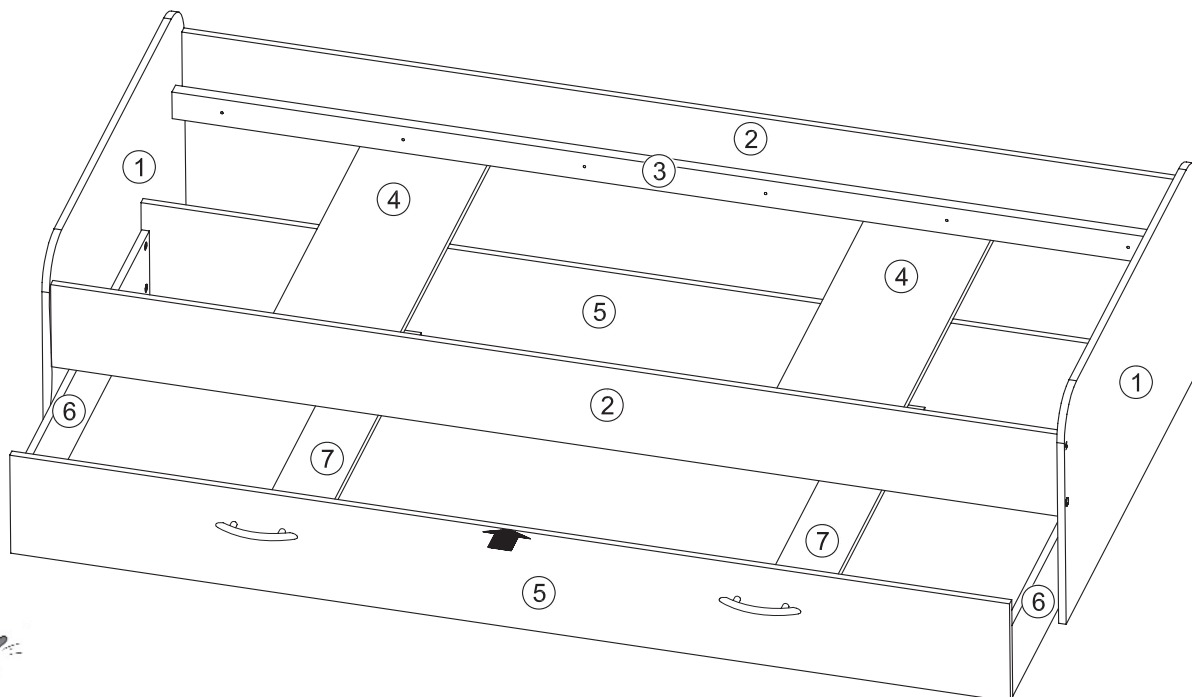

**Pflegehinweis / Cleaning information / Istruzione di cura / Indications d'entretien / Indicaciones de mantenimiento**

Bitte nur mit einem Staubtuch oder einem feuchten Lappen reinigen. Keine scheuernden Putzmittel verwenden!

Per favore pulire solo con un panno per rimuovere polvere o con uno straccio umido. Non usare detergenti abrasivi!

Limpiar sólo con un trapo para el polvo o con un trapo húmedo. No utilizar productos de limpieza abrasivos!

Please do only clean with a duster or a damp cloth. Do not use any scouring agents!

Ne nettoyer qu'avec un chiffon à poussière ou un chiffon humide. Ne pas utiliser de produit à récurer!