

# Tabea

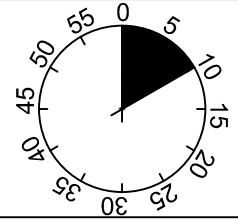

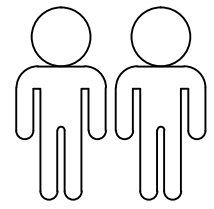
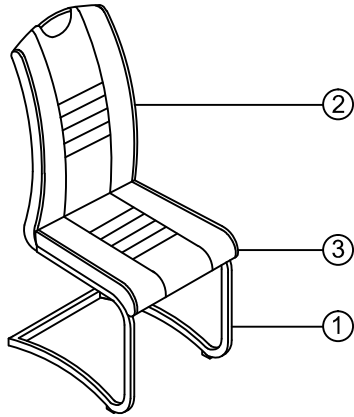

1

2

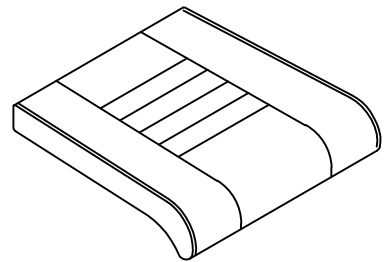
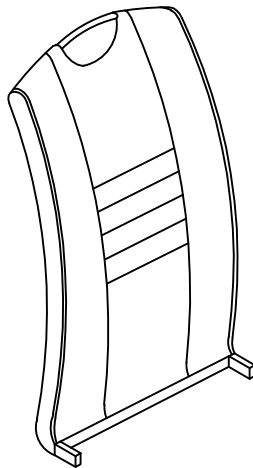
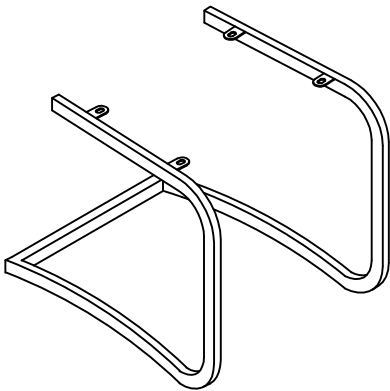
3



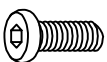

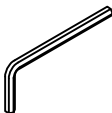

1	1x
2	1x
3	1x

A	M6X20	B	M6X12	C	Ø18xØ6x1.5	D	4MM		
									
4x		4x		4x		1x			

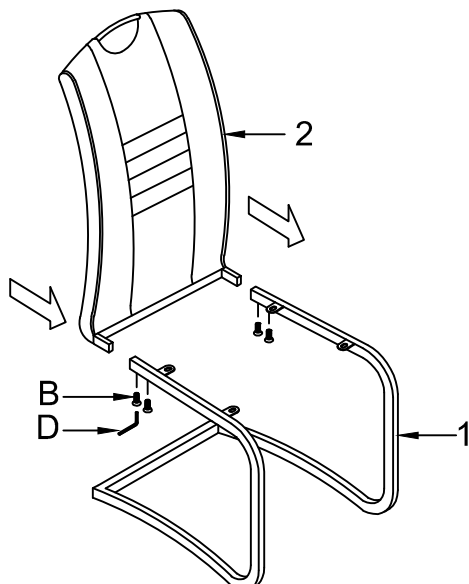
I.





1

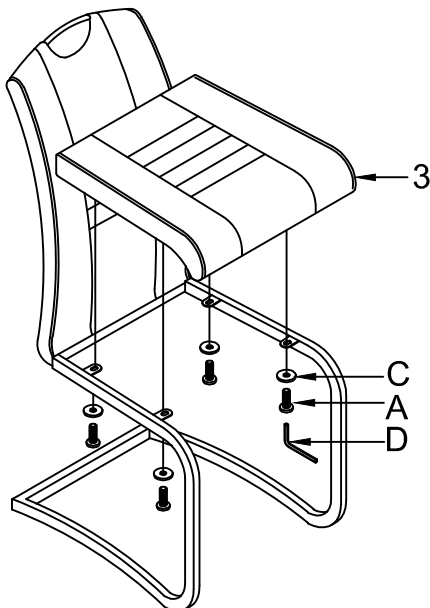

B		M6x12
		4x
D		4MM
		1x
		

2



A		M6X20
		4x
C		Ø18xØ6x1.5
		4x
D		4MM
		1x
		

3

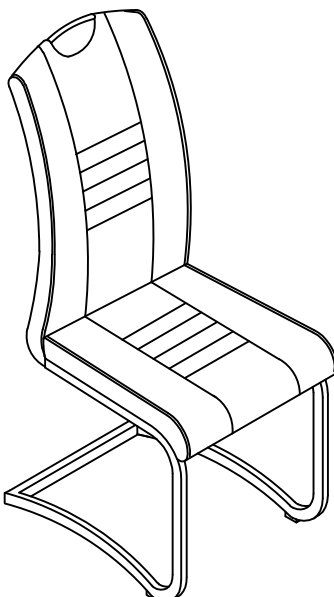

D		4MM
		1x
