

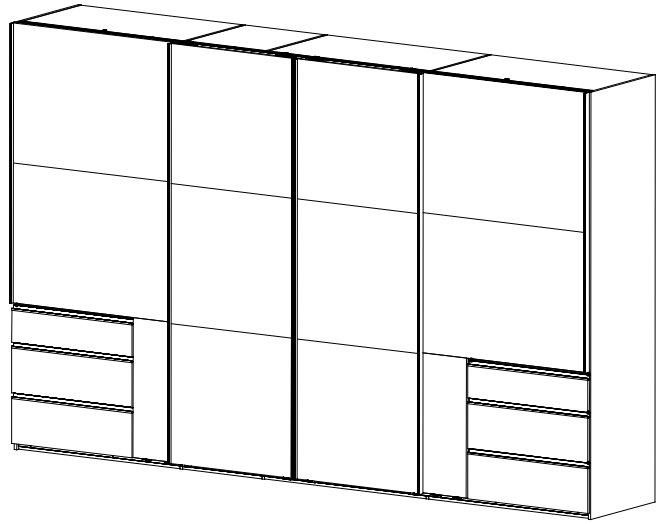

980714

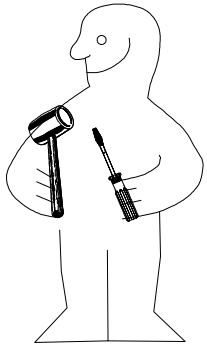

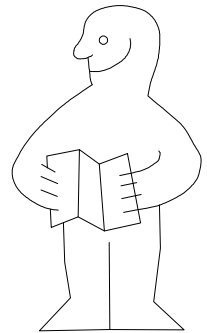

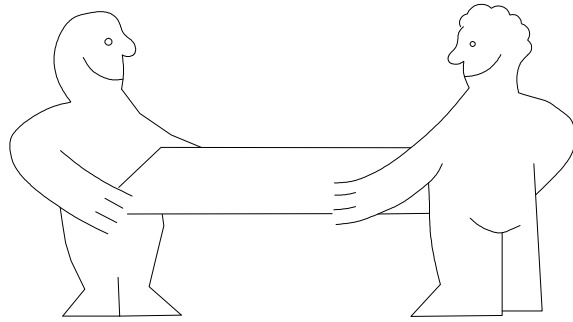
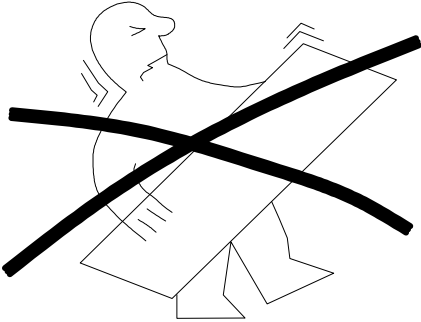

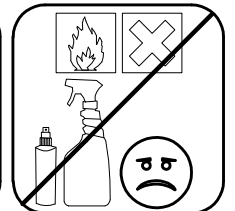
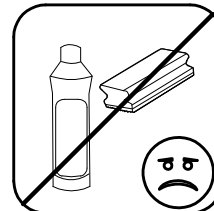
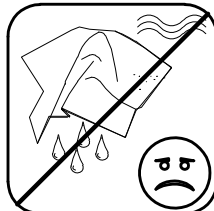
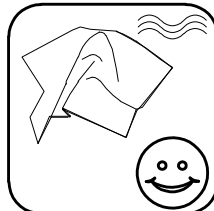
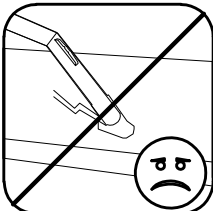
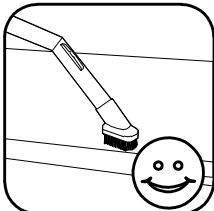
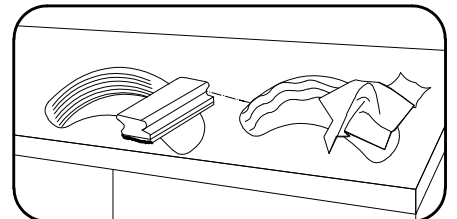
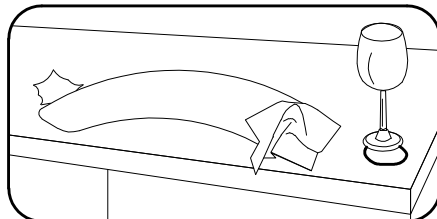
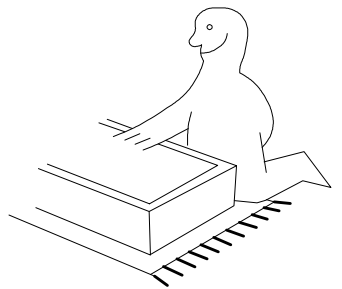
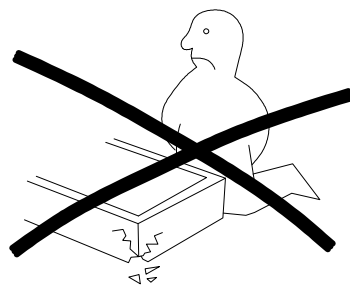
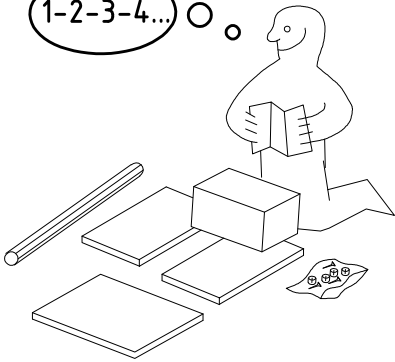

HSP 350 4trg Sy ASK

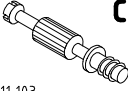









1-2-3-4... ○

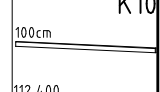
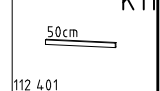







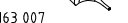





 111 xxx	A1	32x
 111 103	C	8x
	F3	12x
 111 229	F	8x

 111 300	S0	19x
 111 xxx φ12 3,5 x 15 mm	V12	19x
 121 370	G1	54x
 111 252	VB23	8x

 117 002	K2	8x
	SBV	40x
 100cm	K10	3x
 50cm	K11	1x
 112 400	K11	3x
 112 401	K11	1x

 111 611	J2	11x
 6,3 x 10,5 mm	T1	40x
 112 055	L8	24x
 111 607	Z	4x
 163 007	Z	4x

 112 220/1	Q45	6x
 M6 x 10	T3	12x
 112 616	G25	14x
 121 119	G21	24x
 121 113	D	4x
 353 018 φ8 x 30	D	4x

 111 052	o10	1x
 4 X 13mm	SP13	4x
 121 122	D8	12x
 111 152 φ18 x 8 x 4	F5	12x
 111 xxx φ5 x 15 x M4	MS 14	12x
 121 010 M4 x 14	MS 14	12x

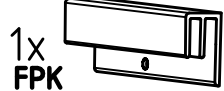

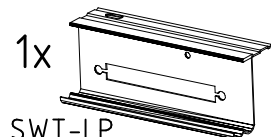

1x FPK  
1453/1940/2430/2920/3408







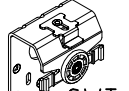



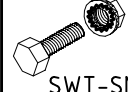



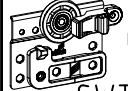
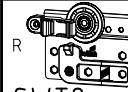

1x SWT-LP  
1453/1940/2430/2920 SY  
/3410 SY



914652800

 3,5 x 15 mm 121 370	G1	2x
	SWT 1	4x
	SWT 2	2x

	SWT-ST	2x
 M4 x 13 mm	SWT-SM5	2x
 121 xxx	GH13	8x
 M4 x 10 mm	G43	8x
 121 xxx	SWH 6	4x
	SWH 7	4x
	SWT 8	1x
	SWT 9	1x

	SWH-SKL	1x
	SWH-SKR	1x
 3,5 x 22 mm	G24	10x
 121 004	G14	2x
 121 375	SP13	146x
 121 122	T2	34x
 111 030	H5	10x
 114 183	KP8	4x
 352 302	KP8	4x

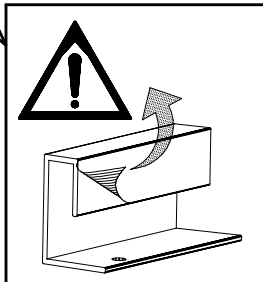
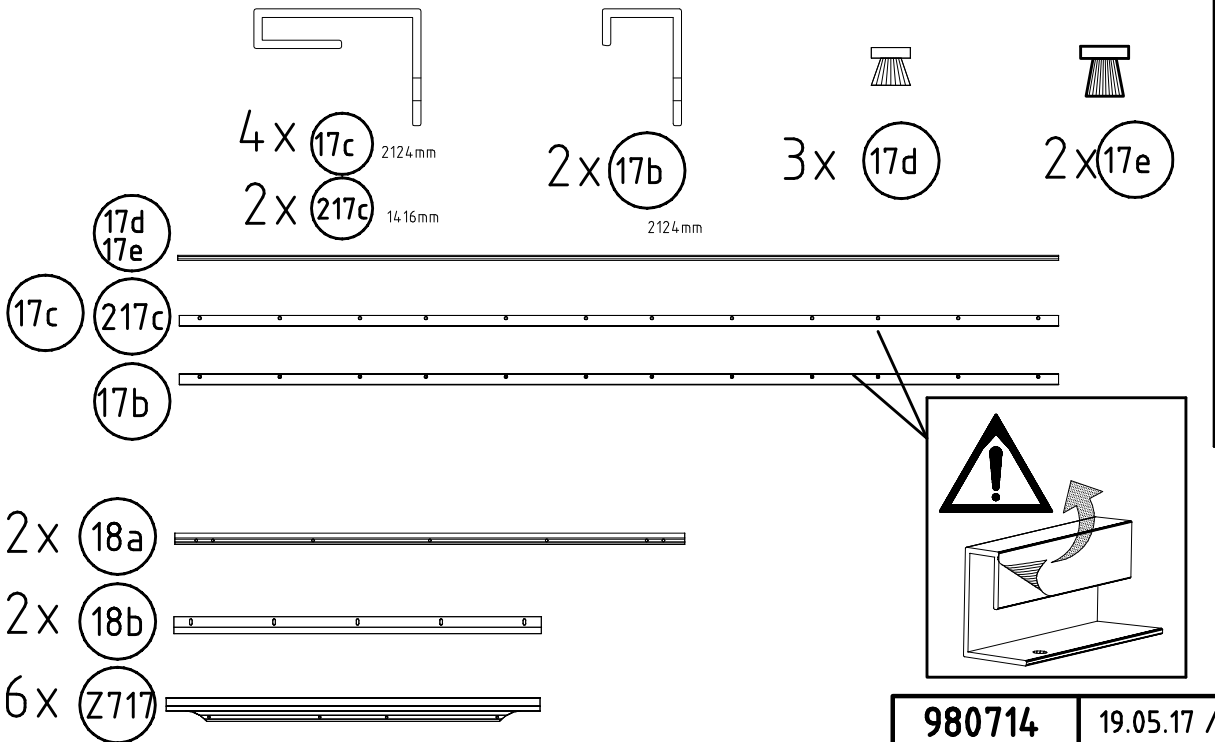
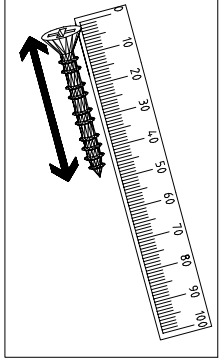
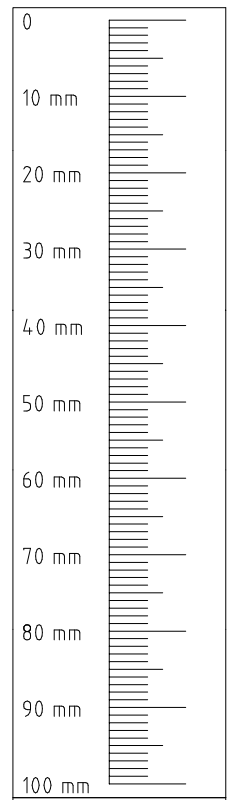
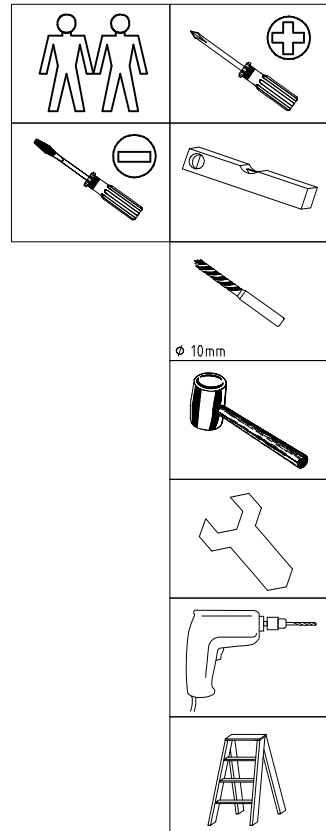

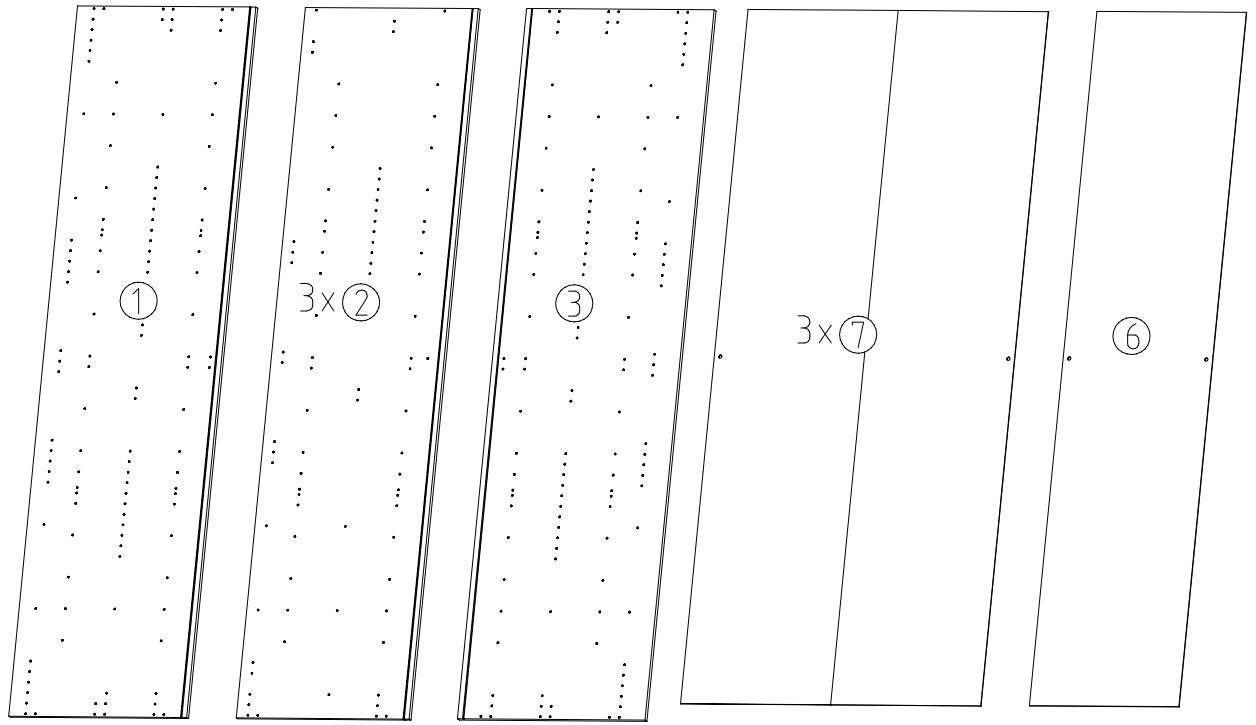

2160x577x15

2160x560x15

2160x577x15

2111x973x2,5

2111x484x2,5

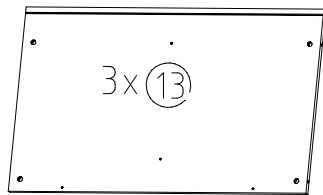

964x560x15

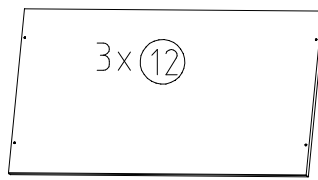

964x500x18

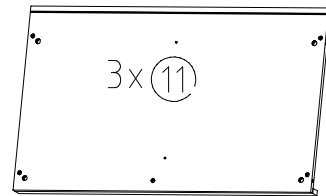

964x560x47

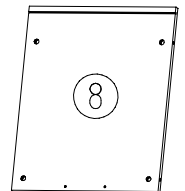

475x560x15

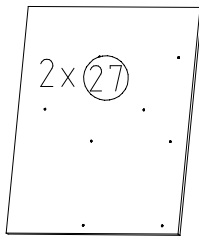

689x557x15

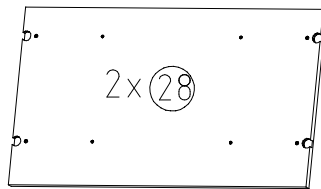

964x540x22

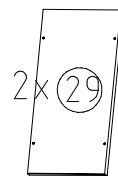

250x500x18

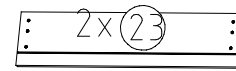

717x163x15

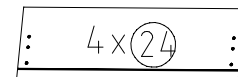

717x227x15

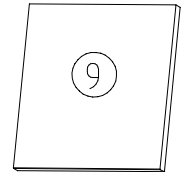

475x500x18

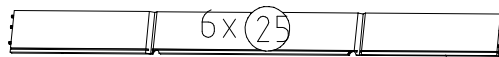

450/675/450x126x12

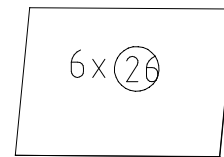

661x449x2,5

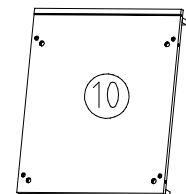

475x560x47

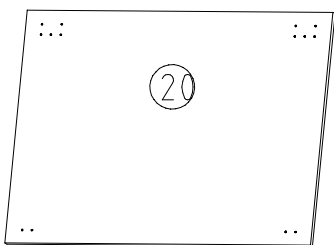

4x 990x708x15

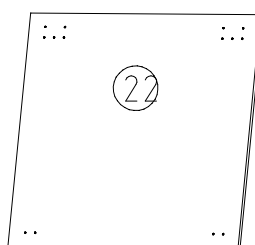

6x745x708x15



2x268x708x15

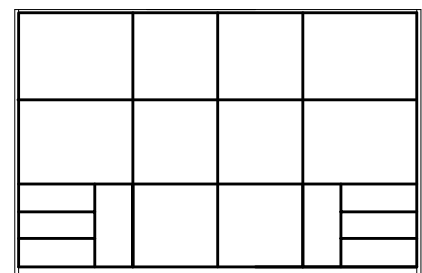

L M M R

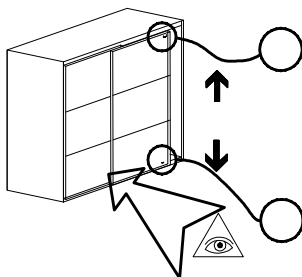

1

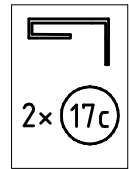
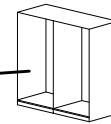
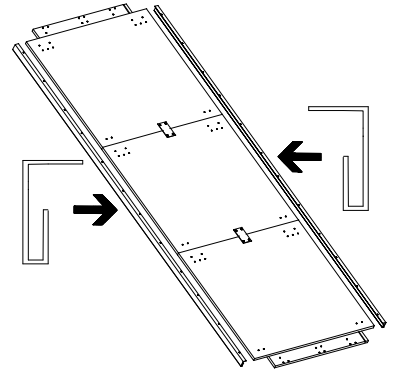
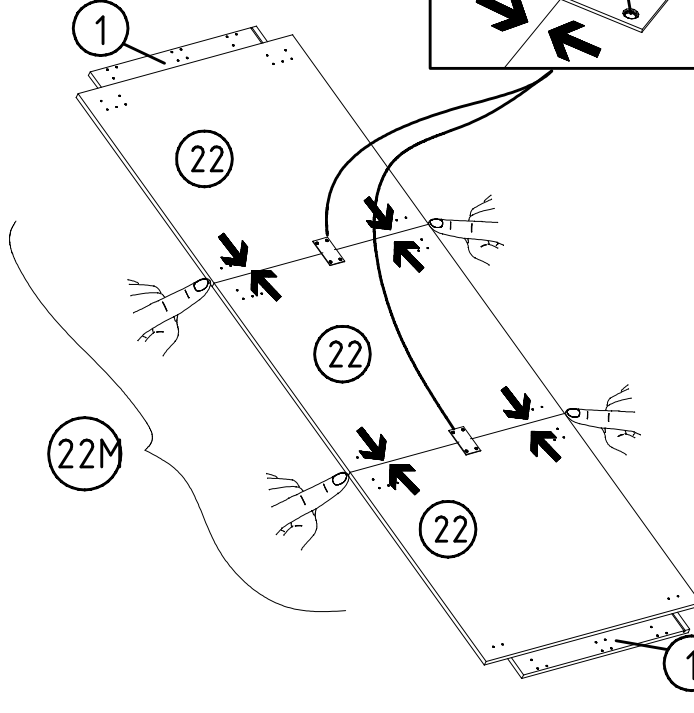
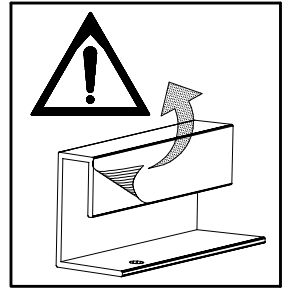
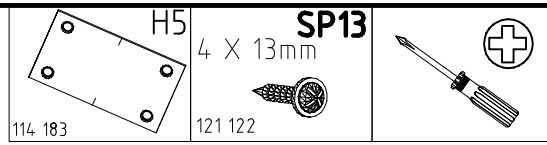
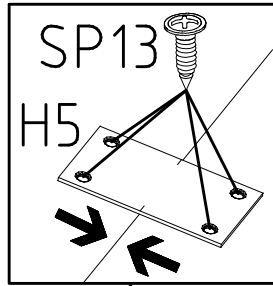
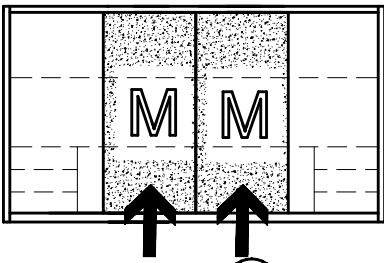

2

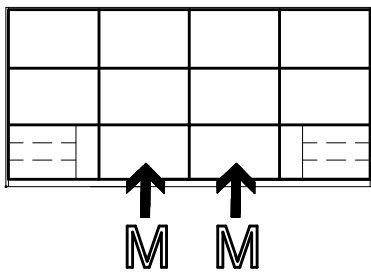
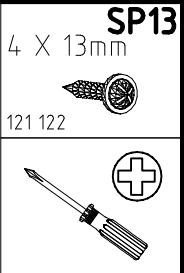
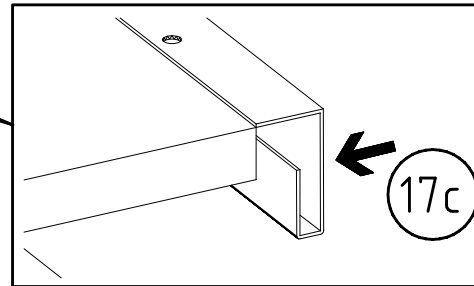
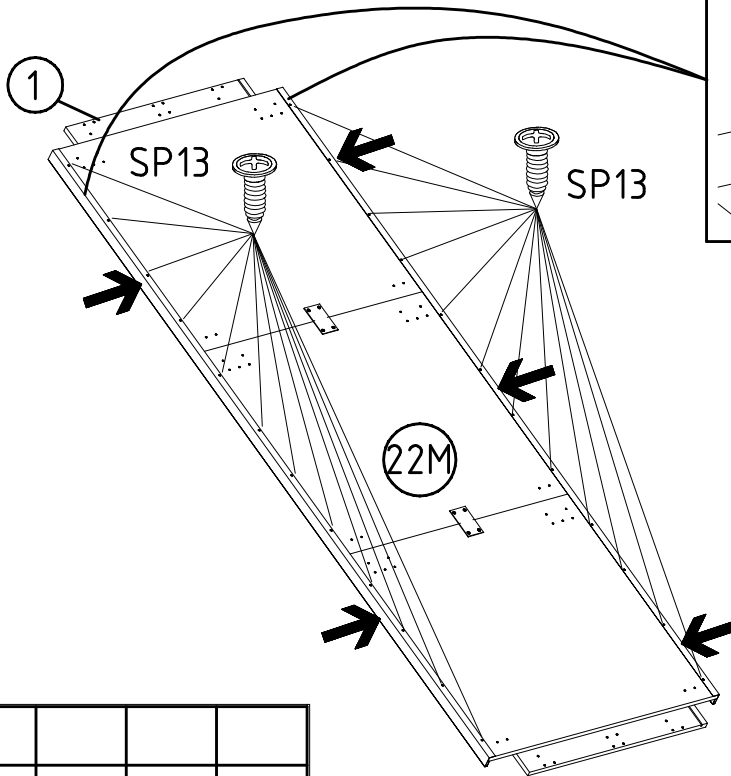

3

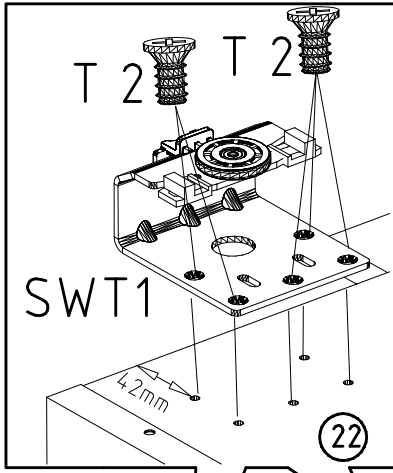
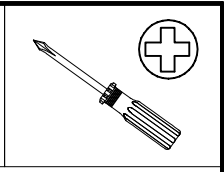
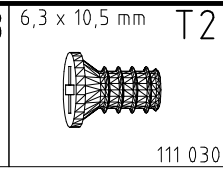
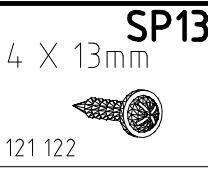
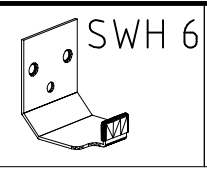
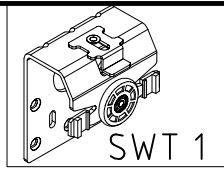

SWT1

T 2 T 2

42mm

22

1

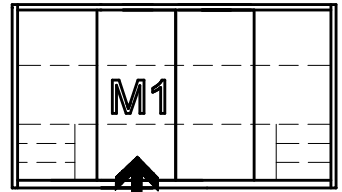
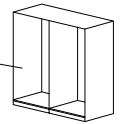

M1

22/M1

22/M2

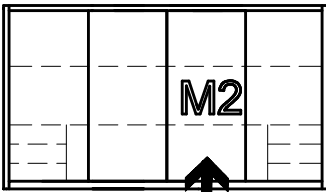

M2

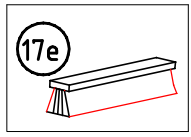

17e

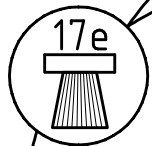

17e

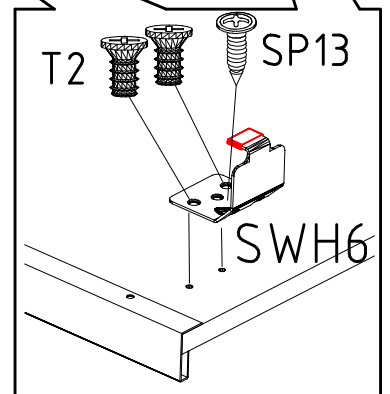

T 2

T 2

T 2

SP13

SWH6

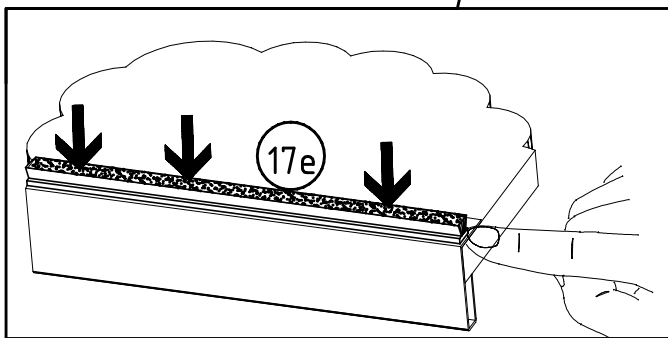
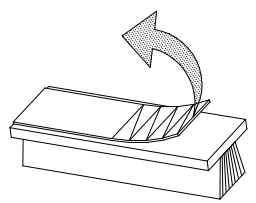

17e

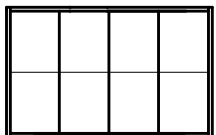

17d

17e

17e

17d

4

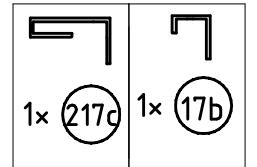
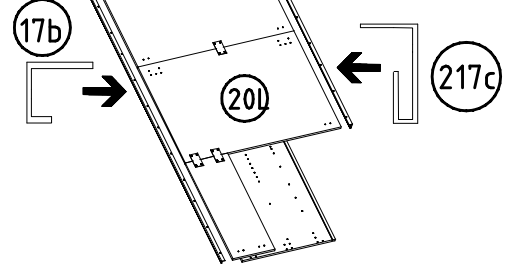
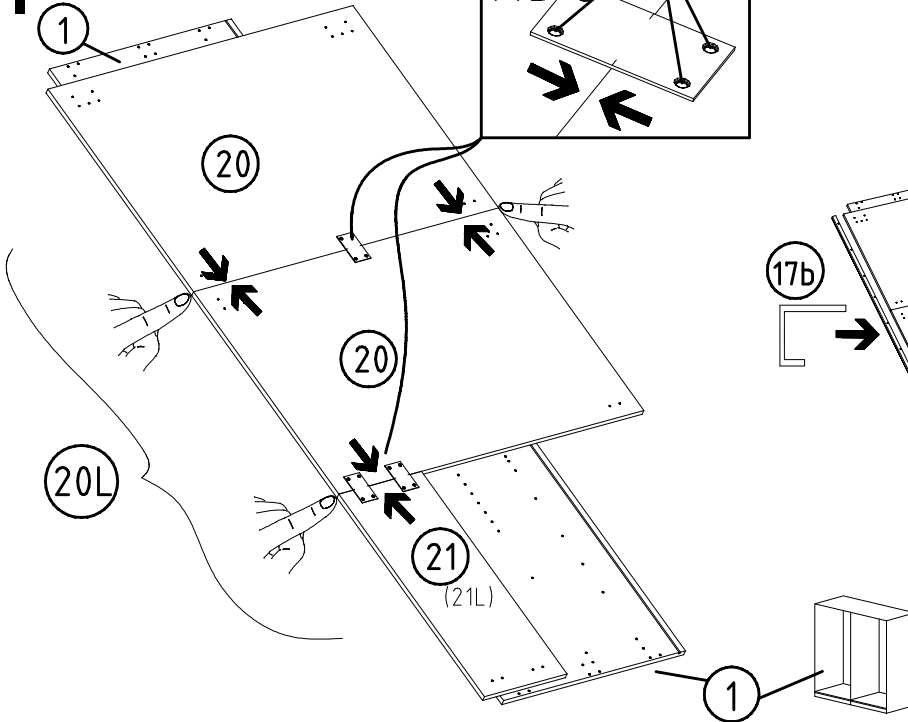
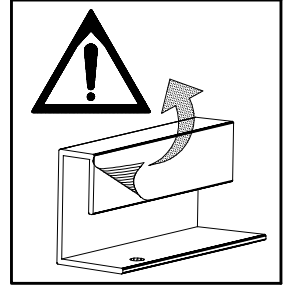
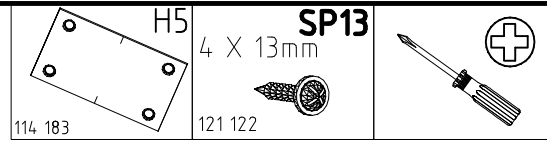
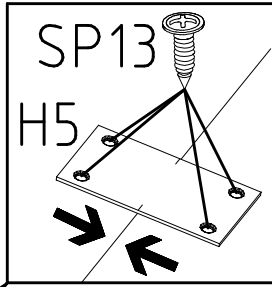
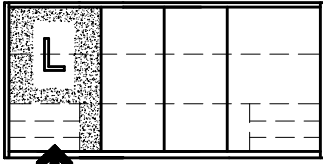

5

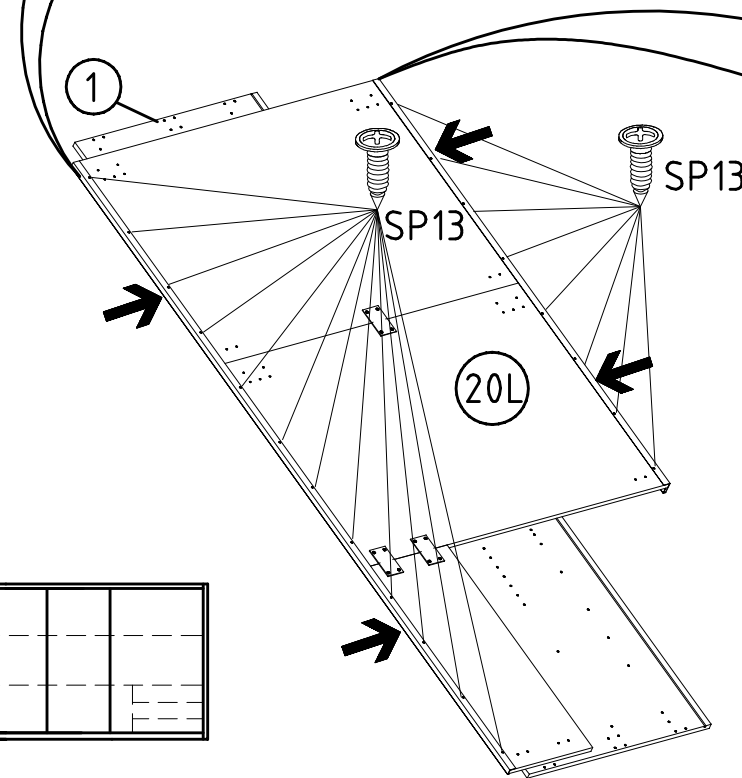
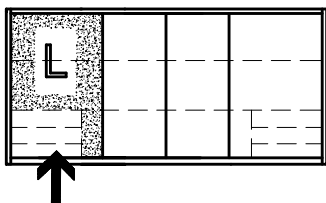
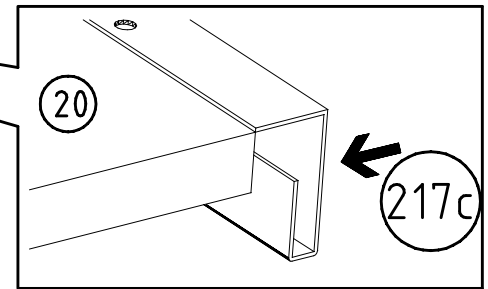
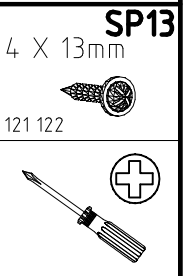
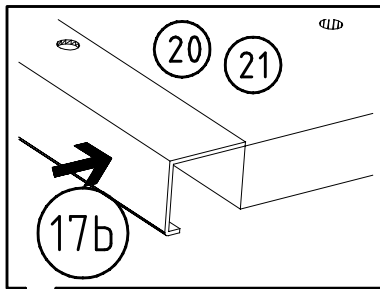

6

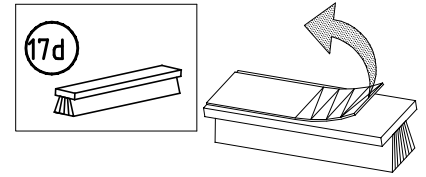
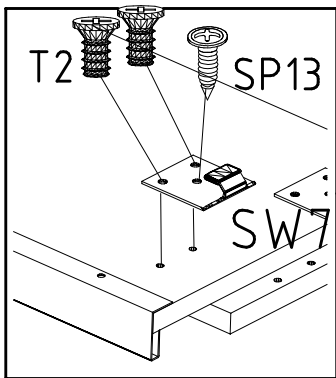
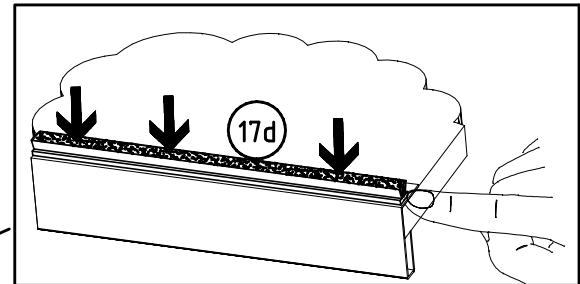
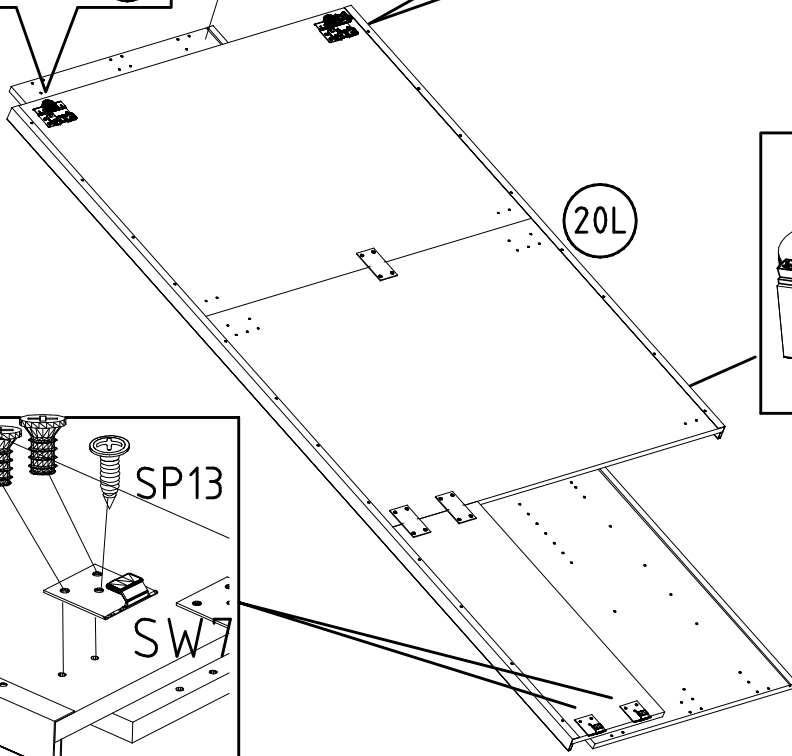
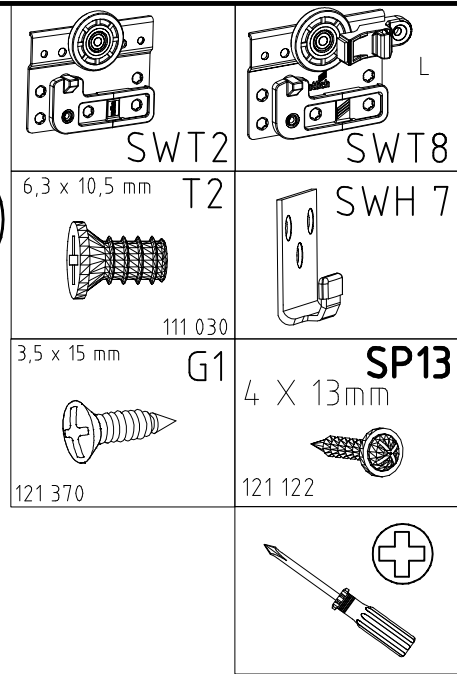
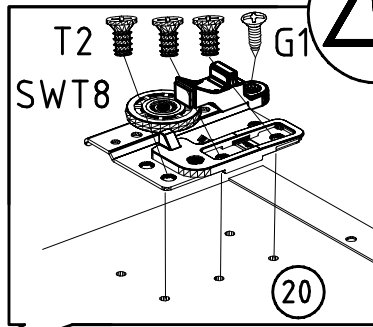
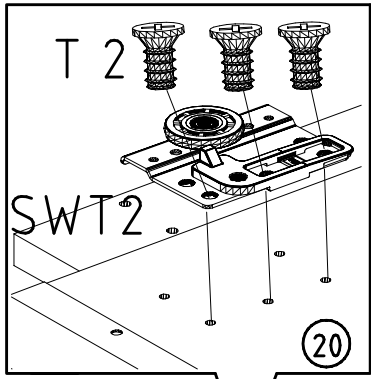
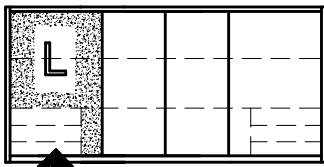

7

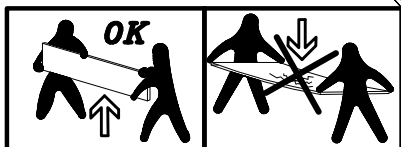
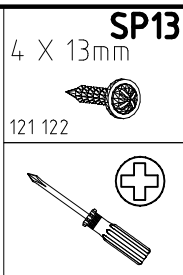
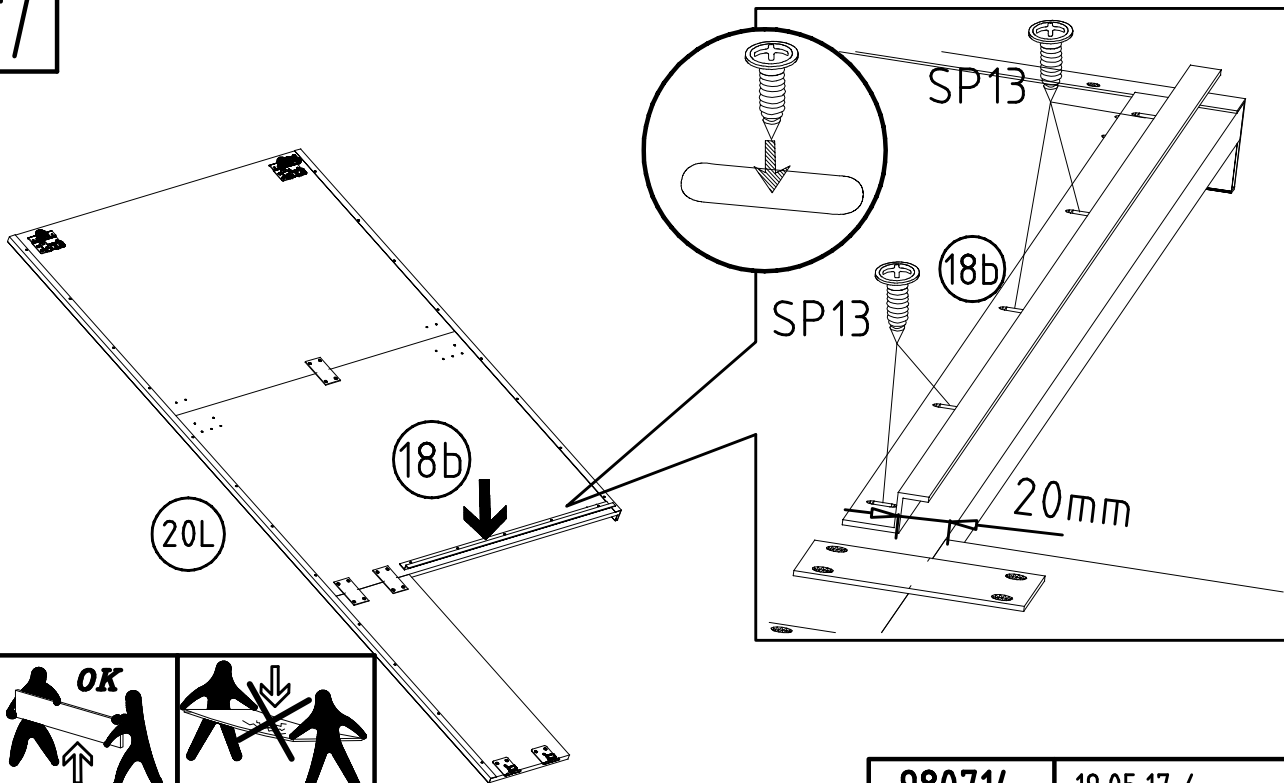

8

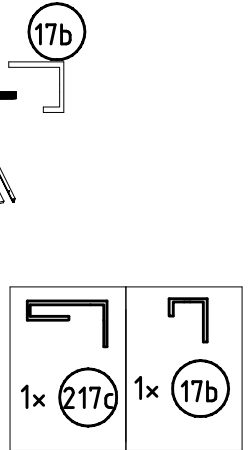
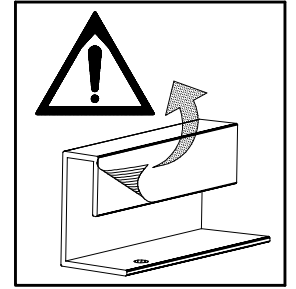
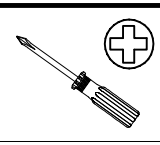
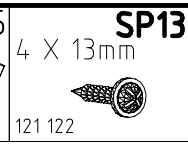
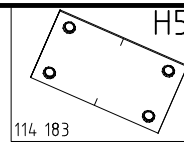
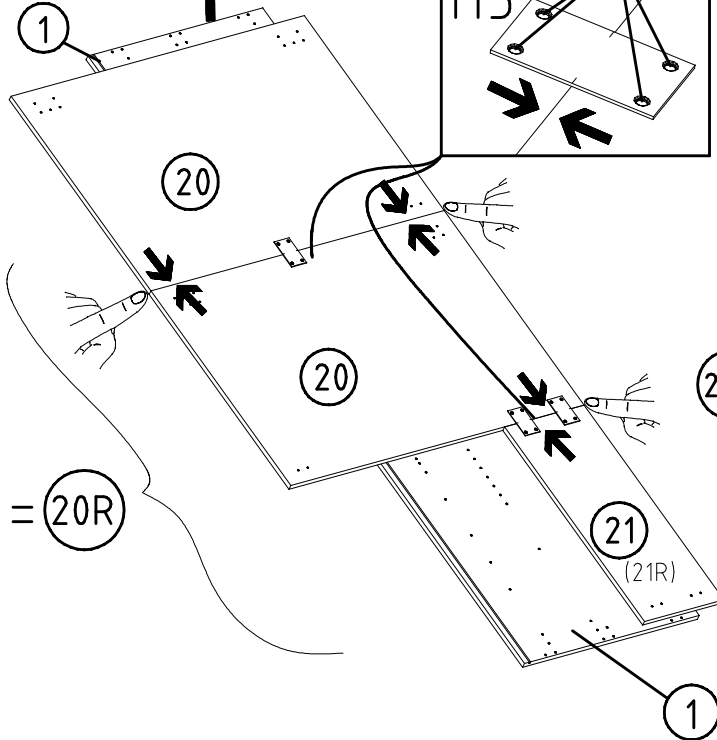
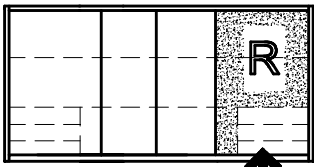

9

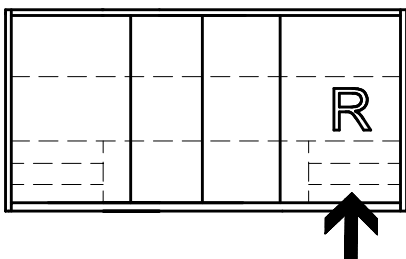
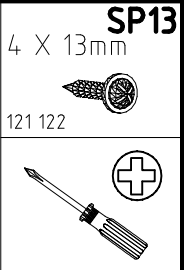
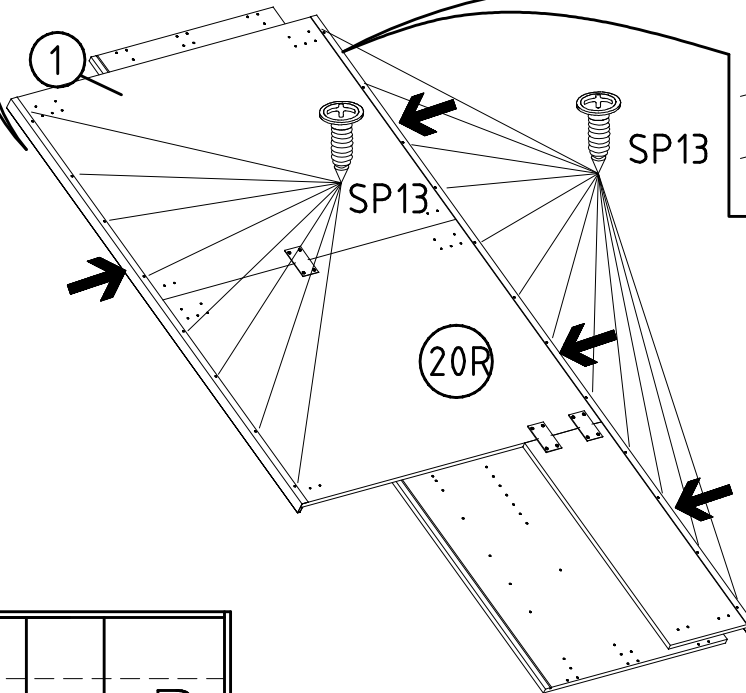
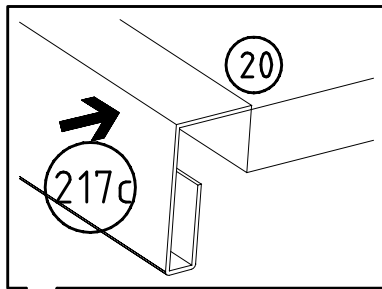



10

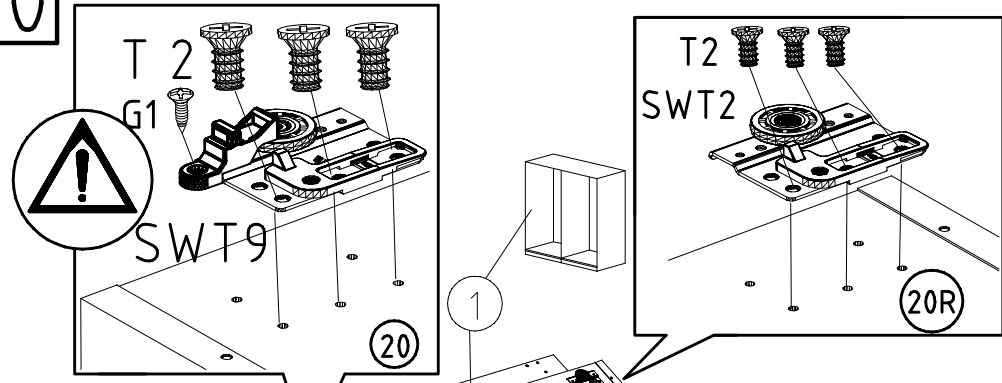

SWT2	SWT9
6,3 x 10,5 mm	T2
111 030	SWH 7
3,5 x 15 mm	G1
	4 X 13mm
121 370	
	121 122

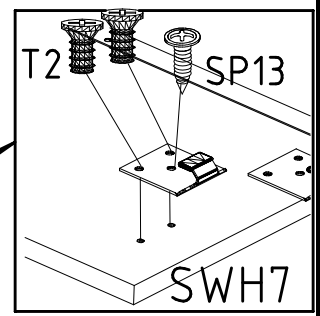
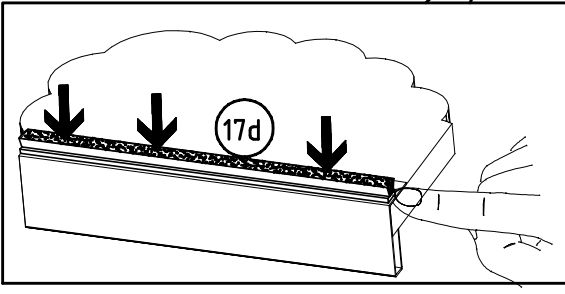
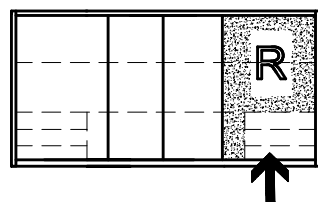
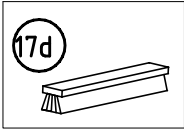
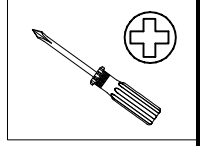

11

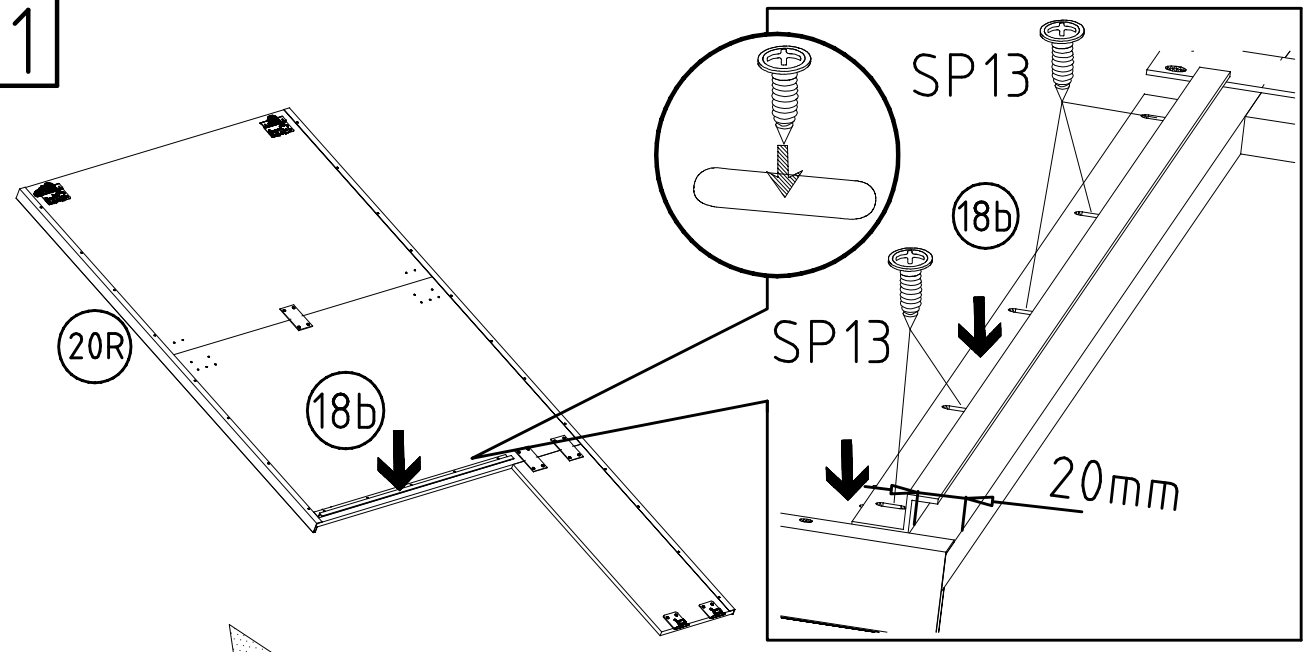

4 X 13mm
121 122

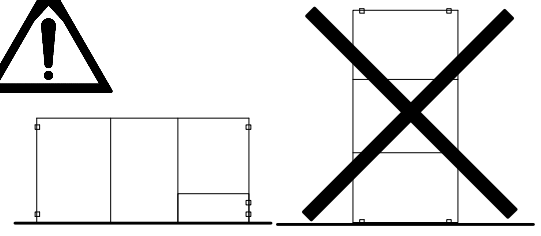
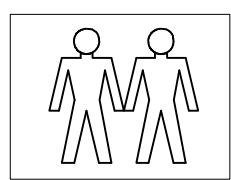
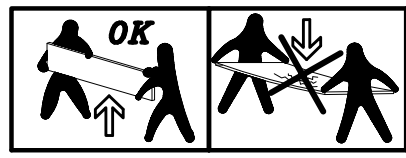
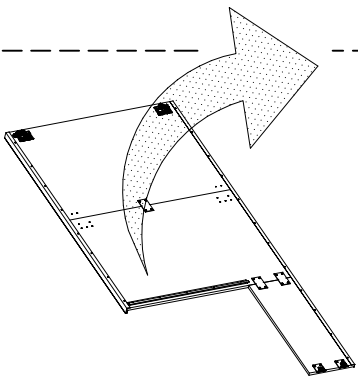

12

3,5 x 15 mm

G1

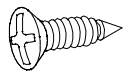

121 370

S0

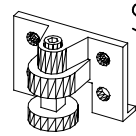

111 300

A1

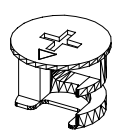

111 xxx

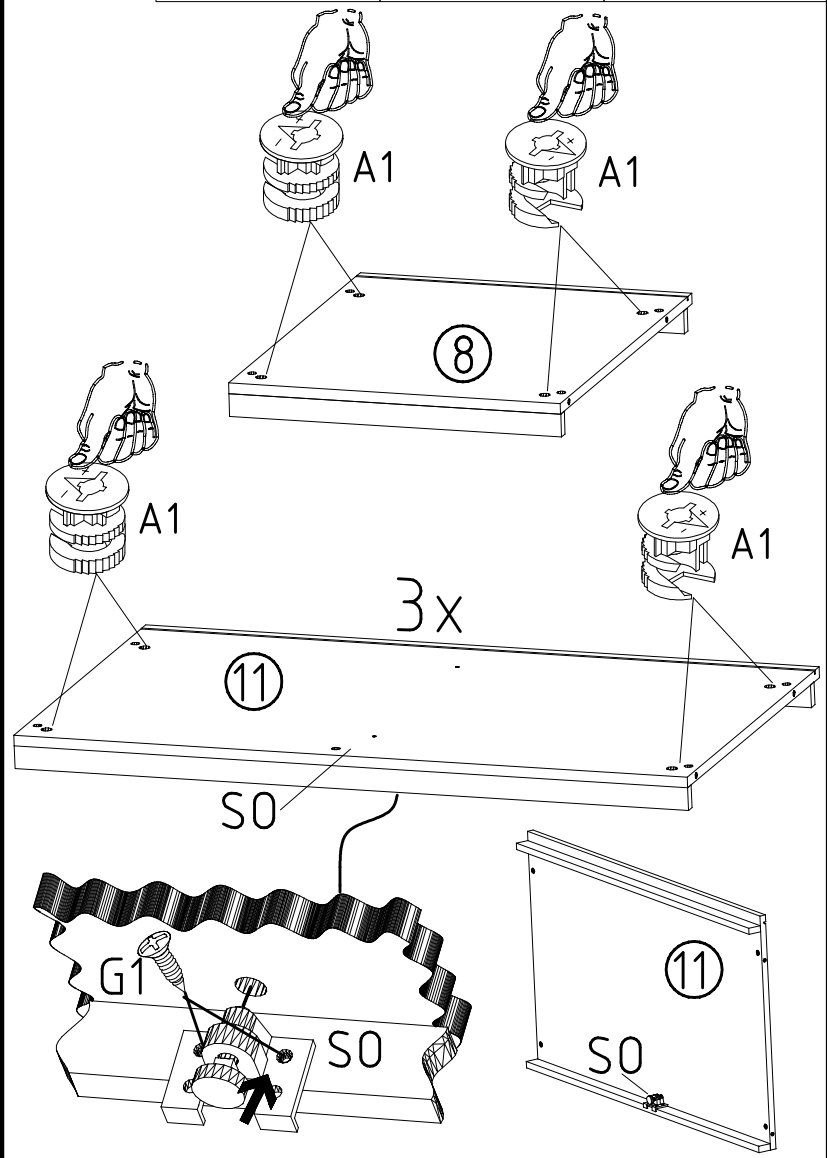

13

A1

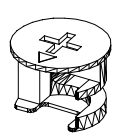

111 xxx

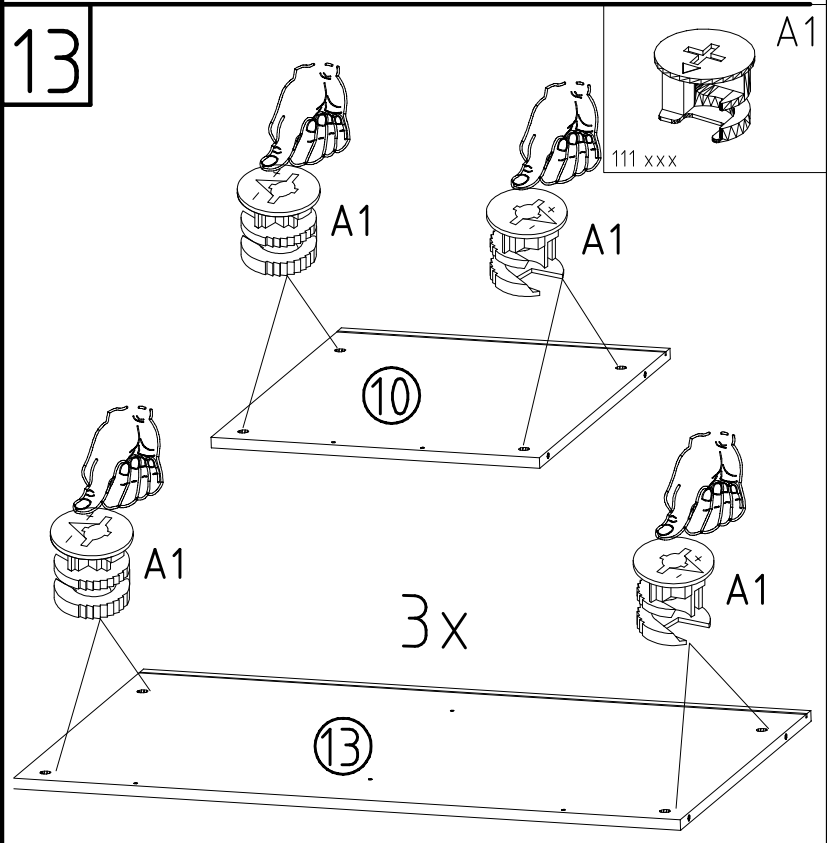

14

F3

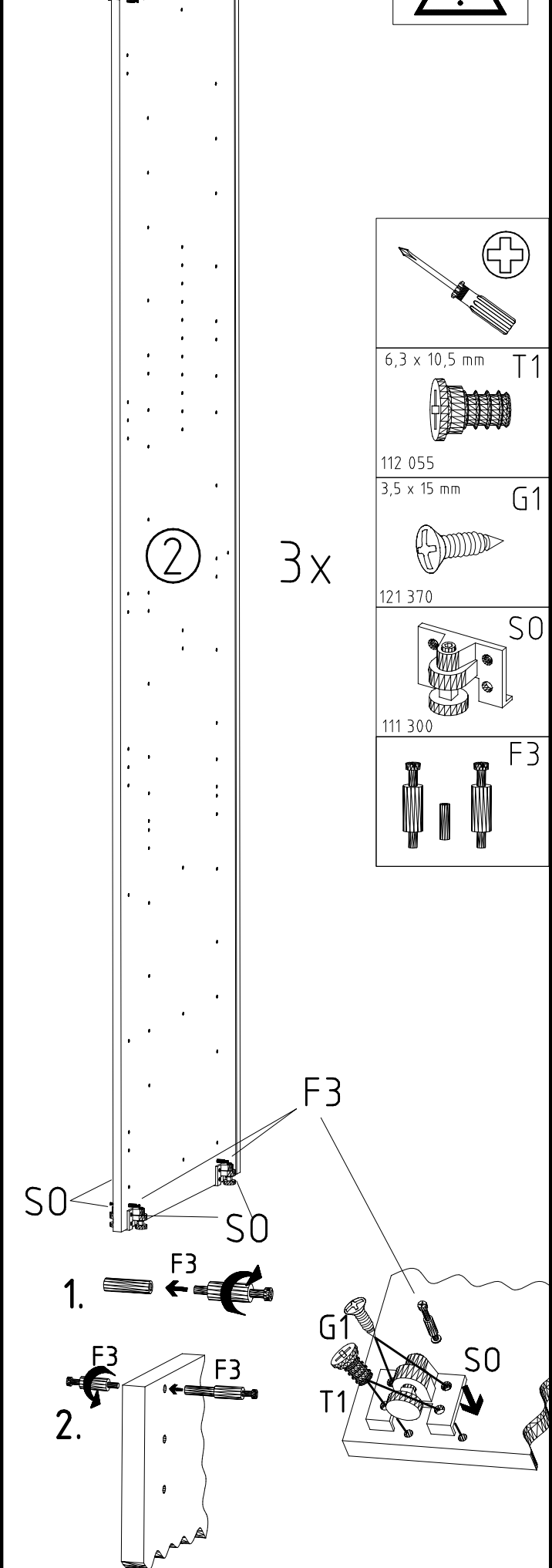

Parts list for step 14:

- Screwdriver (indicated by a plus sign icon)
- 6,3 x 10,5 mm T1
- 112 055
- 3,5 x 15 mm G1
- 121 370
- Bracket S0 (111 300)
- Bracket F3

980714

19.05.17 / -

05 17 | 10/26

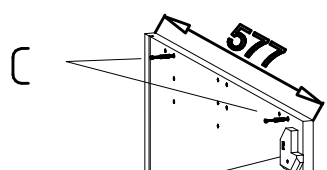
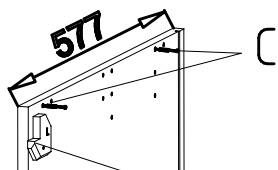
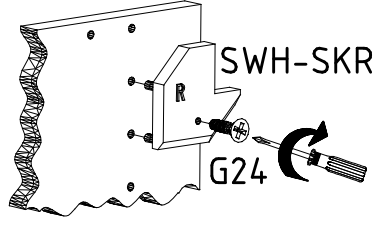
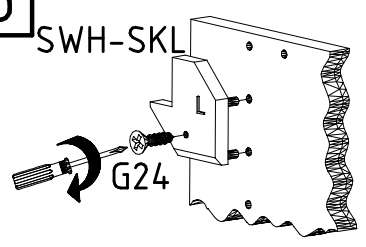

SWH-SKL  
+G24

SWH-SKR  
+G24

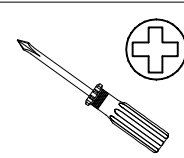

SWH-SKL

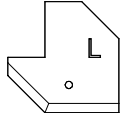

SWH-SKR

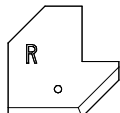

3,5 x 22 mm G24

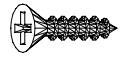

121 004

6,3 x 10,5 mm T1

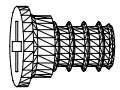

112 055

3,5 x 15 mm G1

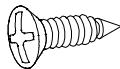

121 370

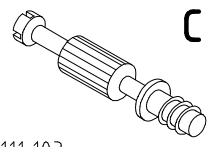

111 103

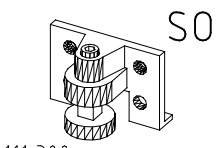

111 300

1

3

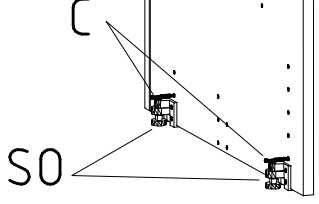
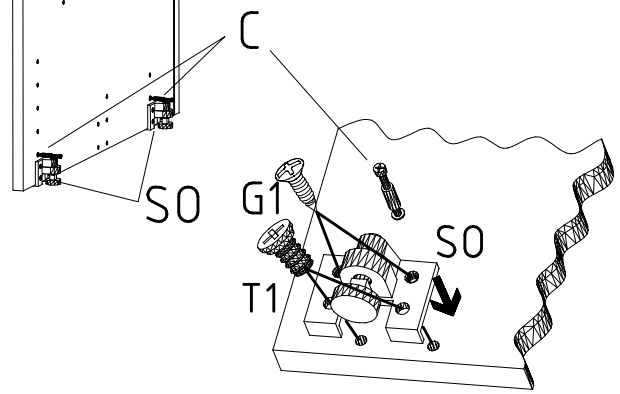

16

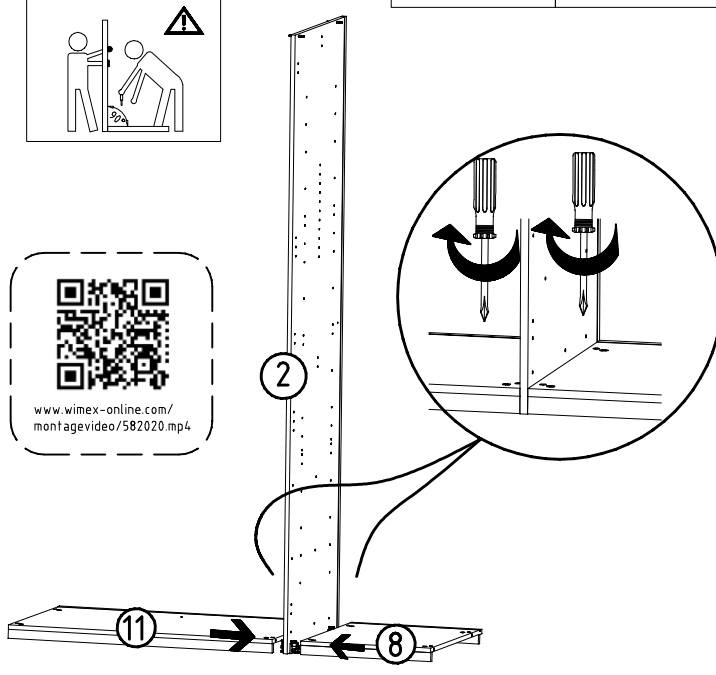
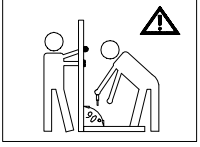
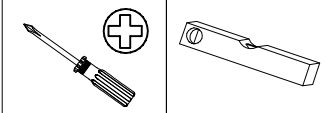

17

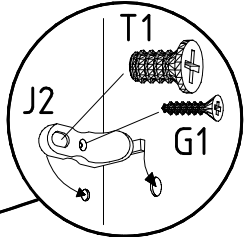
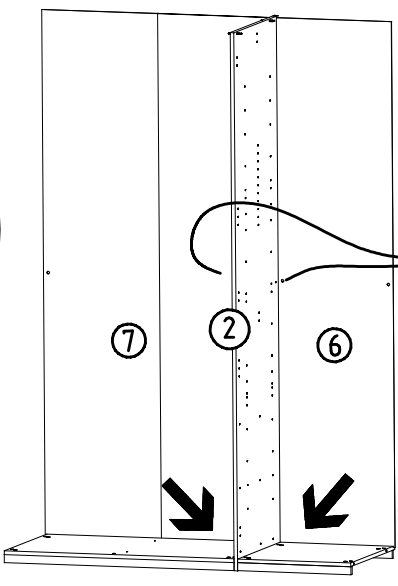
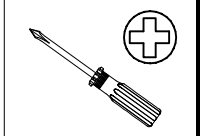

- 3,5 x 15 mm G1
- 121 370
- 111 611
- 6,3 x 10,5 mm T1
- 112 055

18

- 3,5 x 15 mm G1
- 121 370
- 6,3 x 10,5 mm T1
- 112 055
- 111 611
- J2

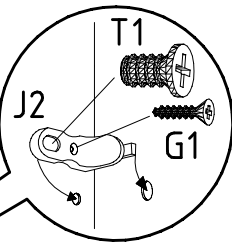
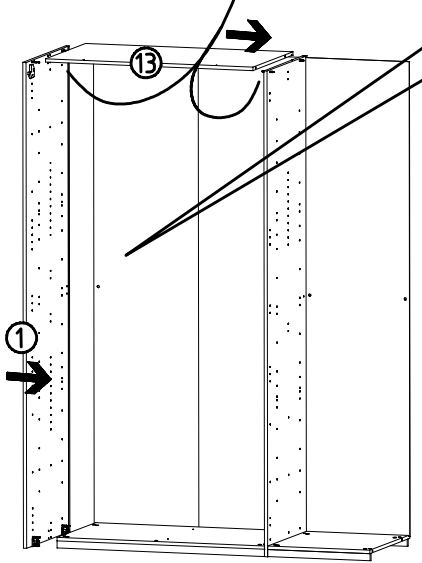
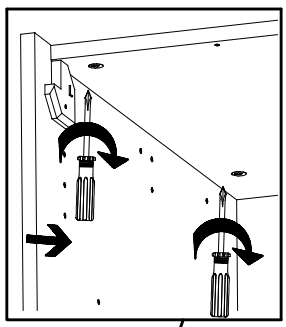

19

- 3,5 x 15 mm G1
- 121 370
- 6,3 x 10,5 mm T1
- 112 055
- 111 611
- J2

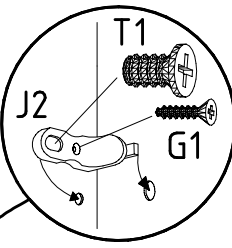
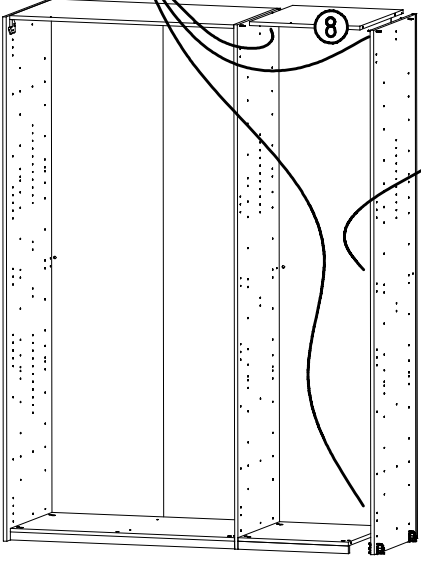
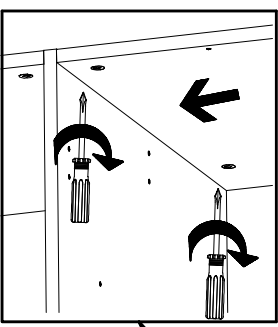

20

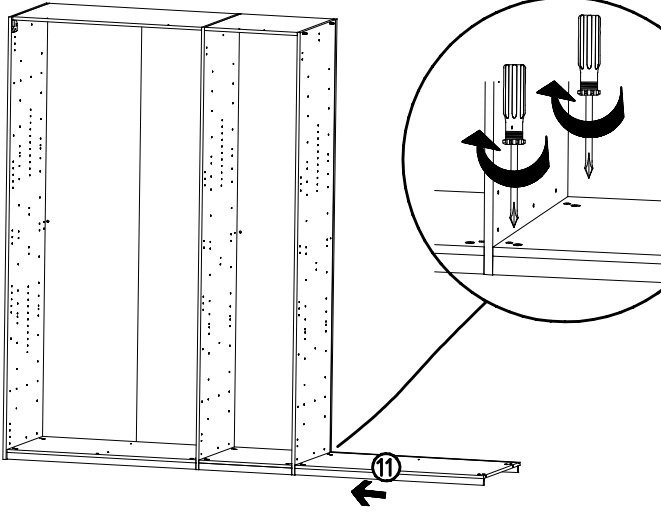
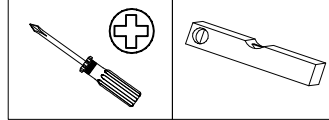
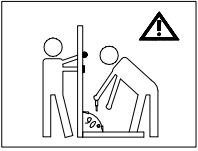

21

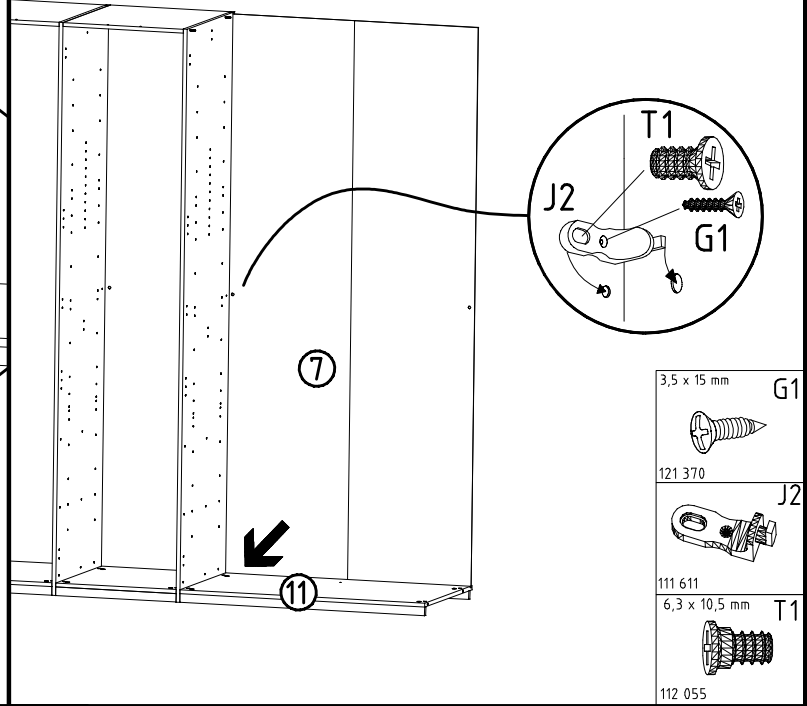
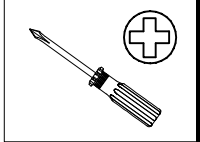

- 3,5 x 15 mm G1
- 121 370 J2
- 111 611 6,3 x 10,5 mm T1
- 112 055

22

- 
- 3,5 x 15 mm G1
- 121 370 J2
- 111 611 6,3 x 10,5 mm T1
- 112 055

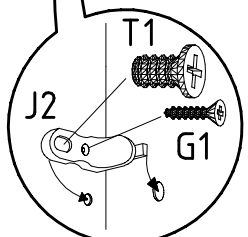
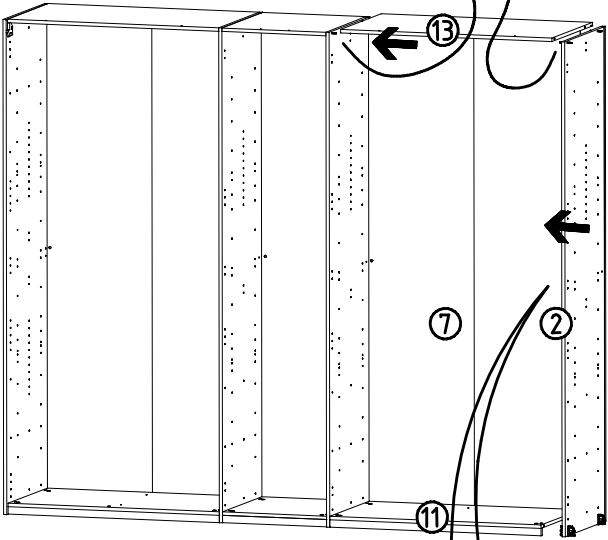
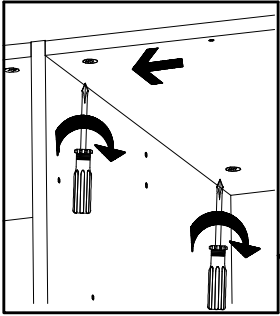

23

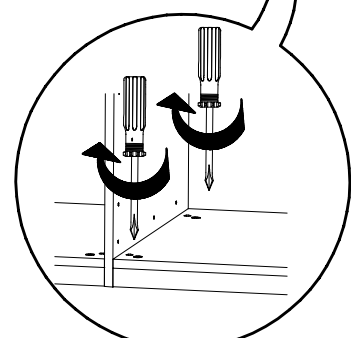
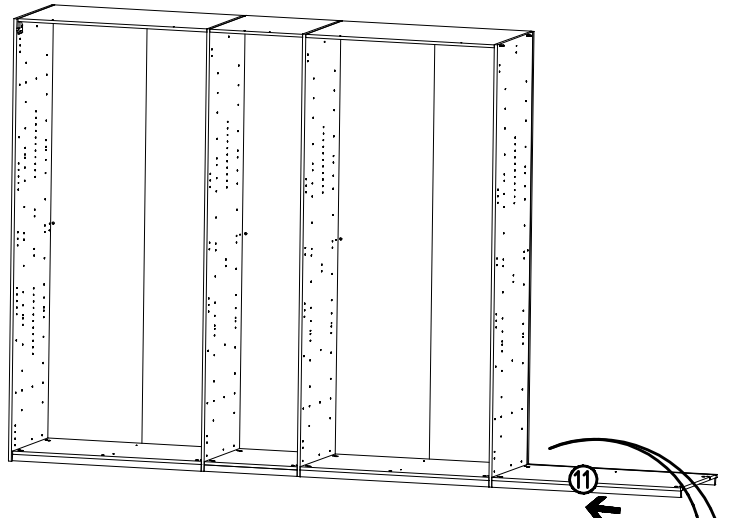
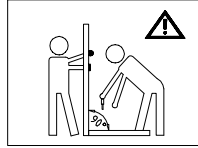
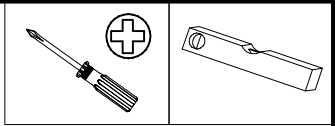

24

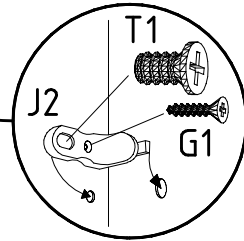
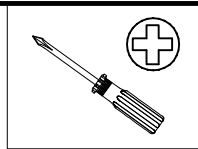
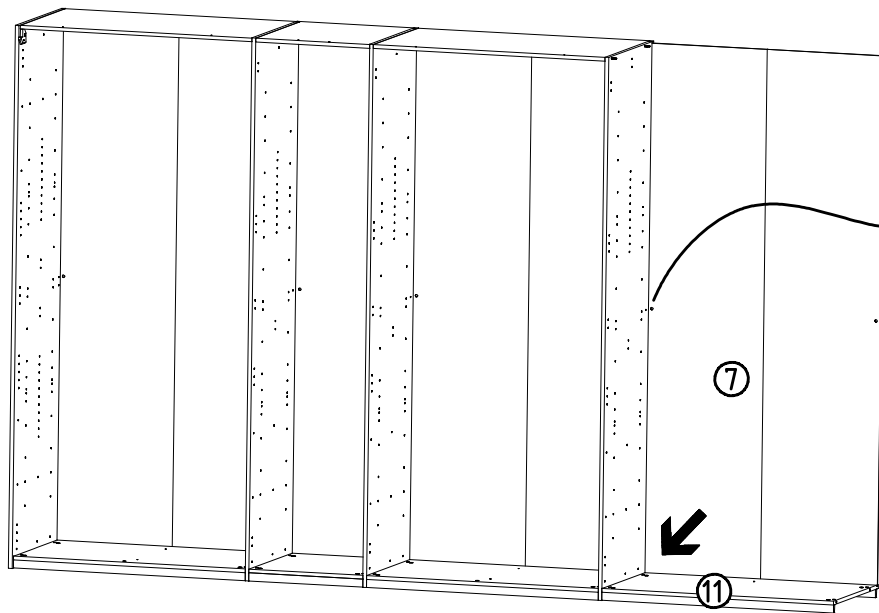

- 3,5 x 15 mm G1
- 121 370
- 111 611
- 6,3 x 10,5 mm T1
- 112 055

25

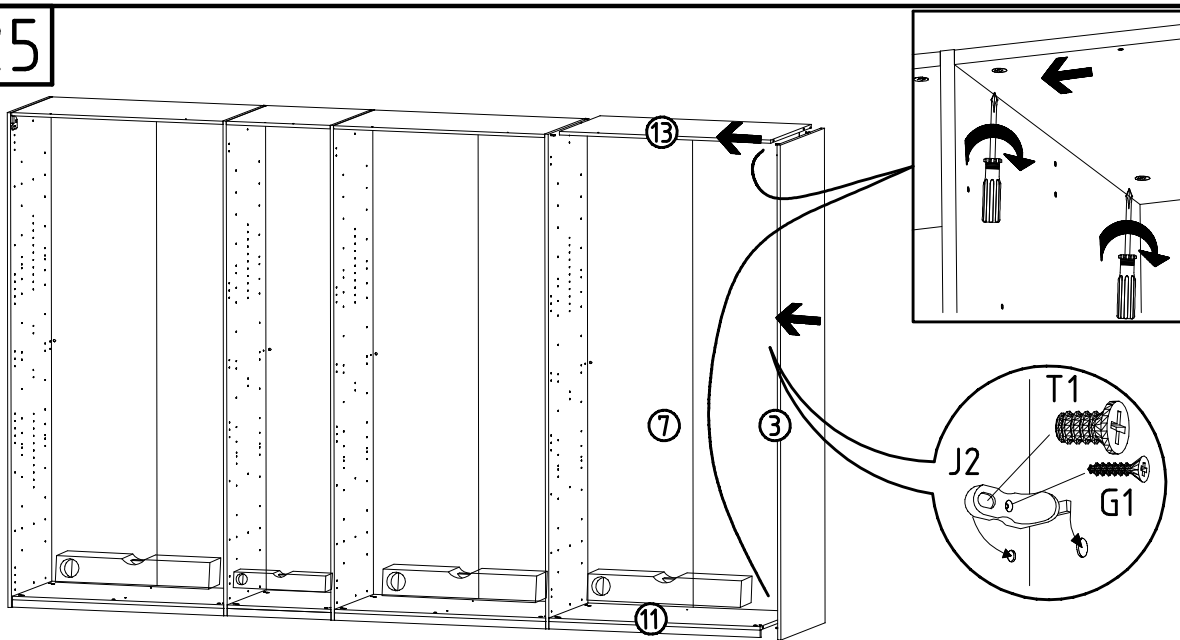

- 3,5 x 15 mm G1
- 121 370
- 111 611
- 6,3 x 10,5 mm T1
- 112 055

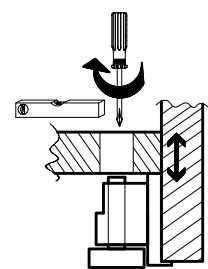

26

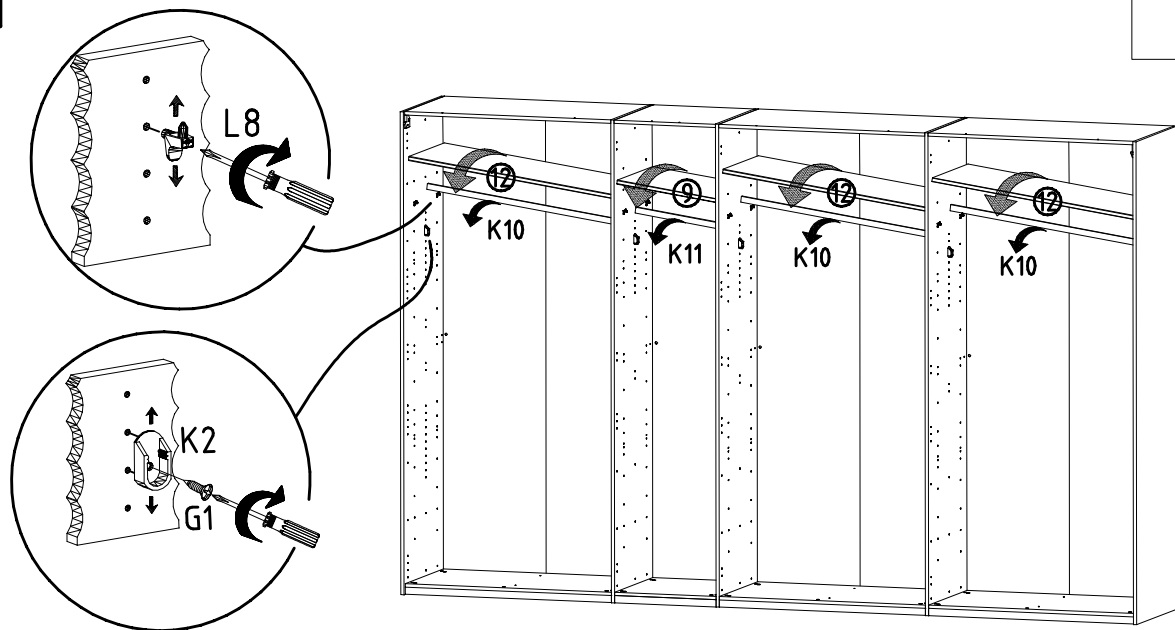

- L8
- 111 607
- K2
- 117 002
- 3,5 x 15 mm G1
- 121 370
- K10
- 100cm
- 112 400
- K11
- 50cm
- 112 401

27

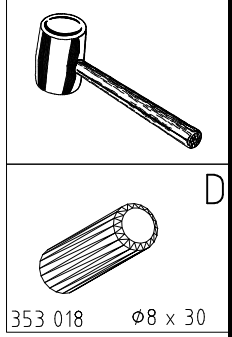
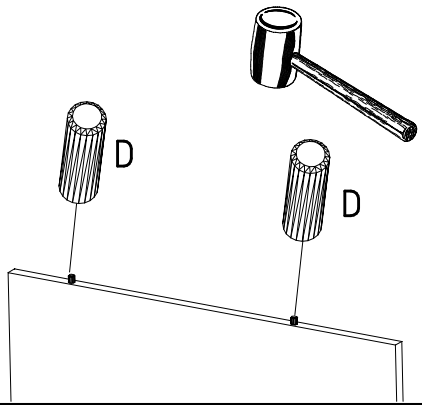
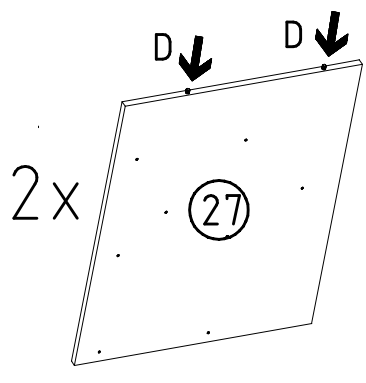

28

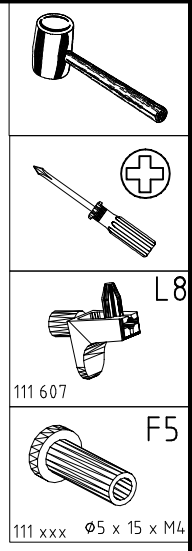
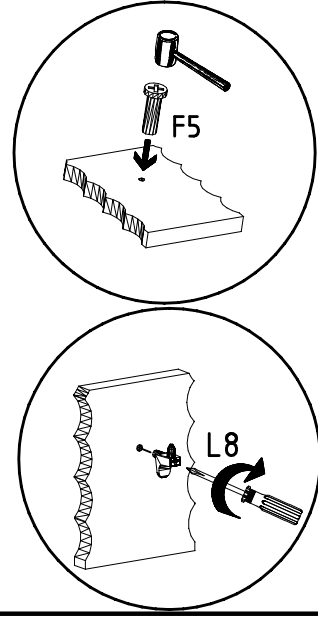
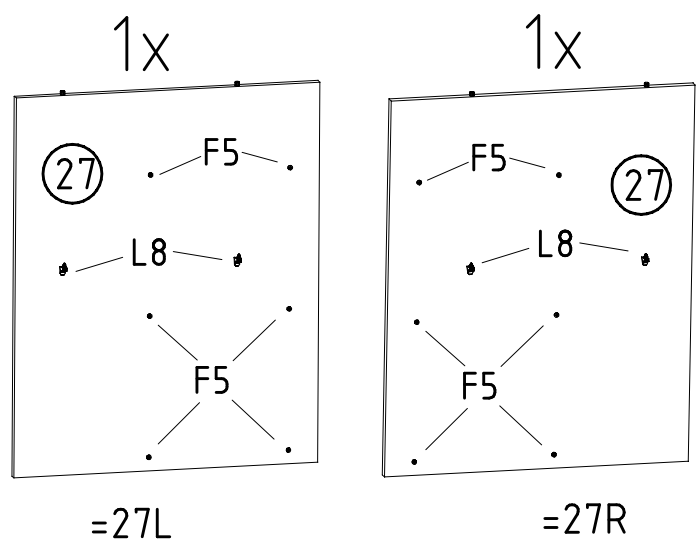

29

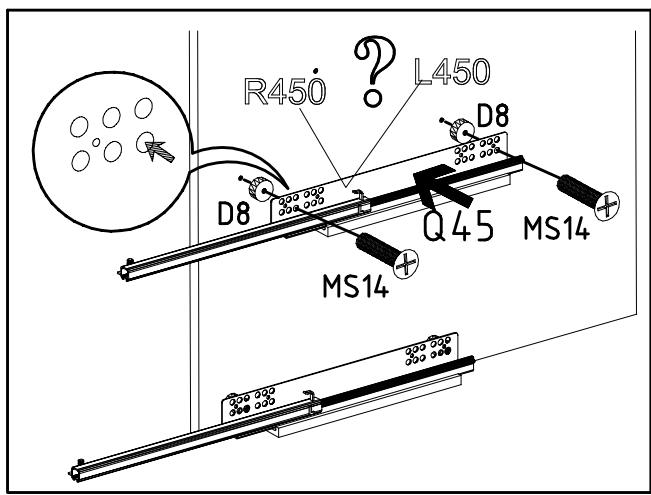
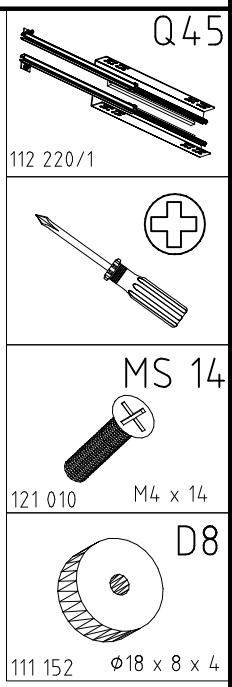
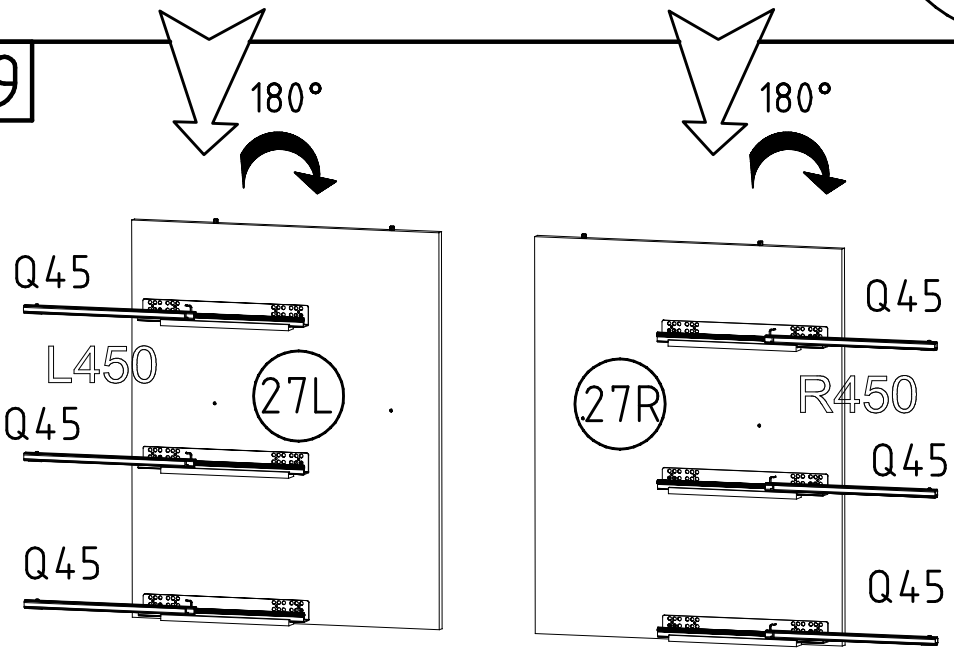

30

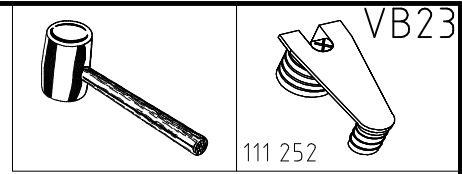
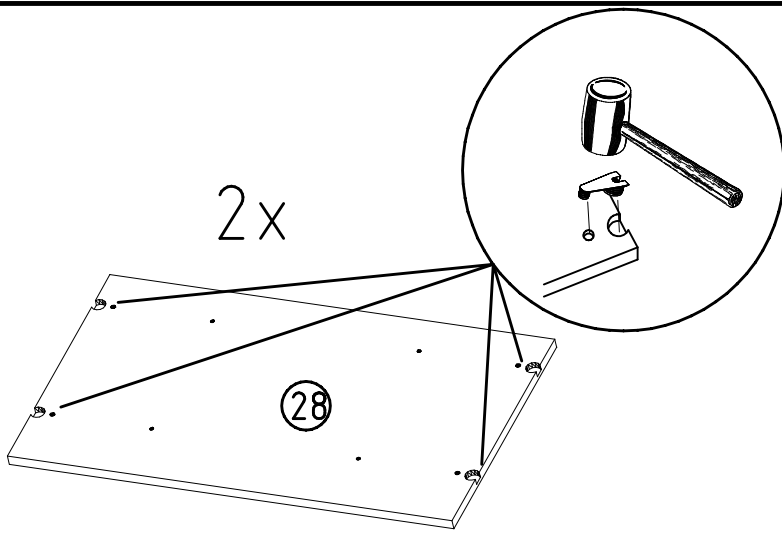

31

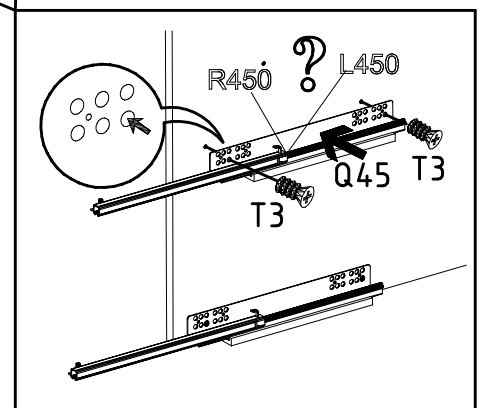
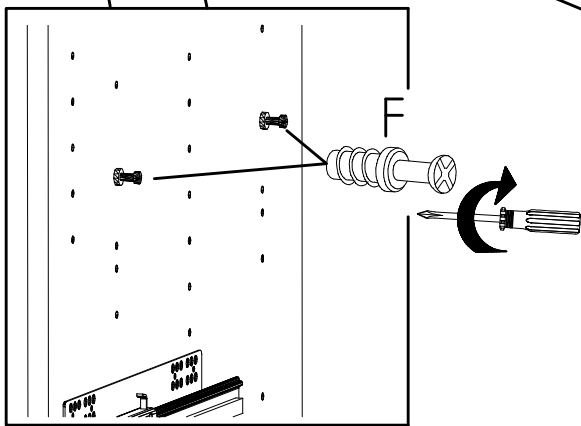
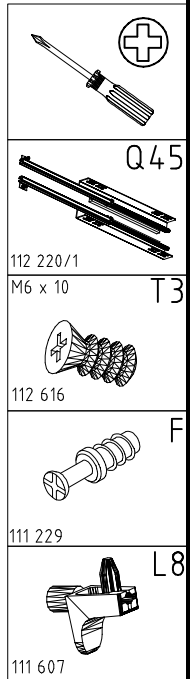
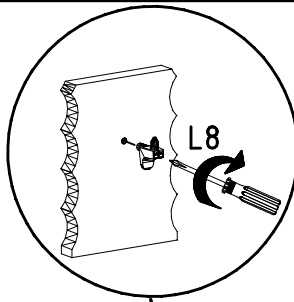
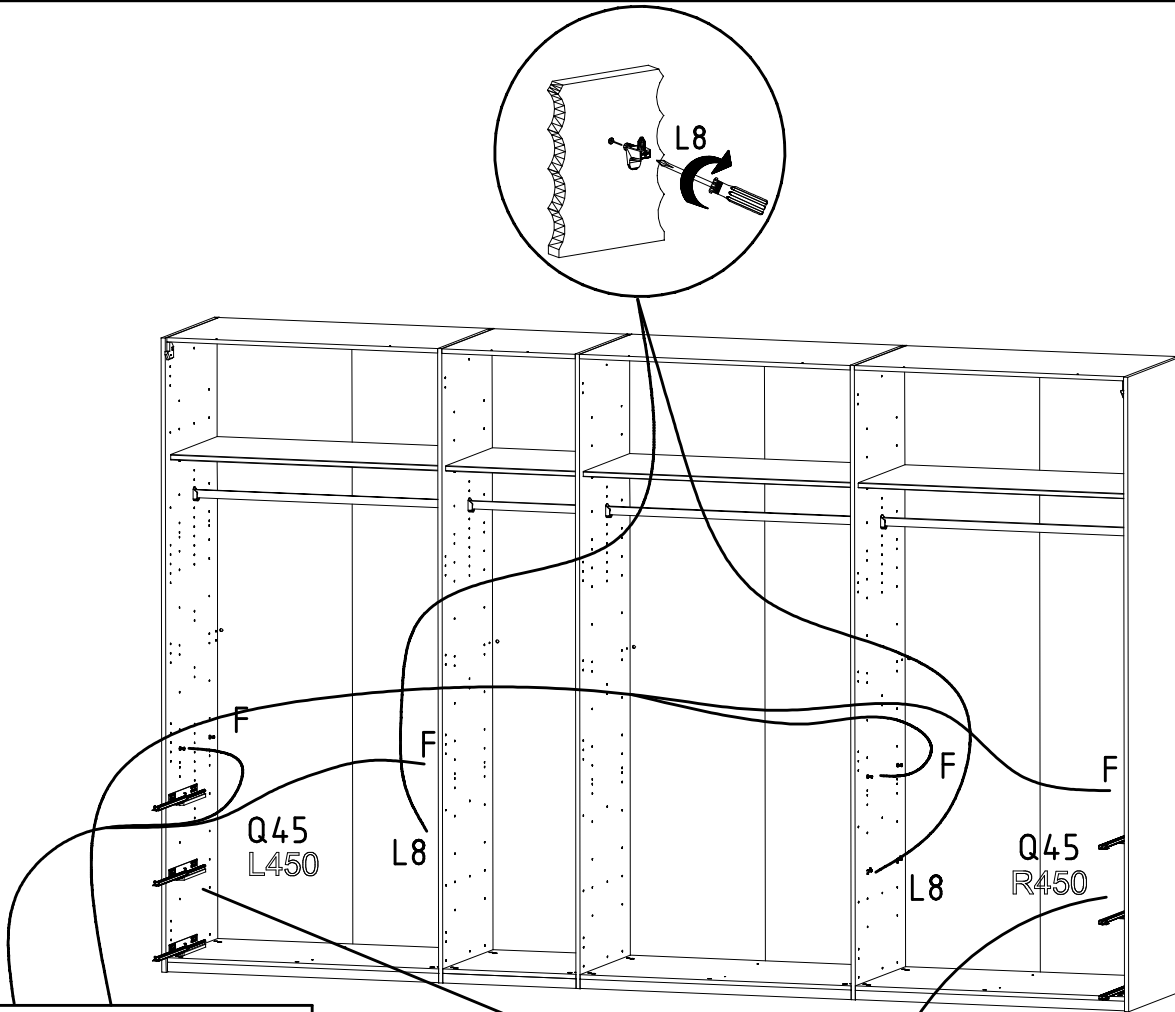



32

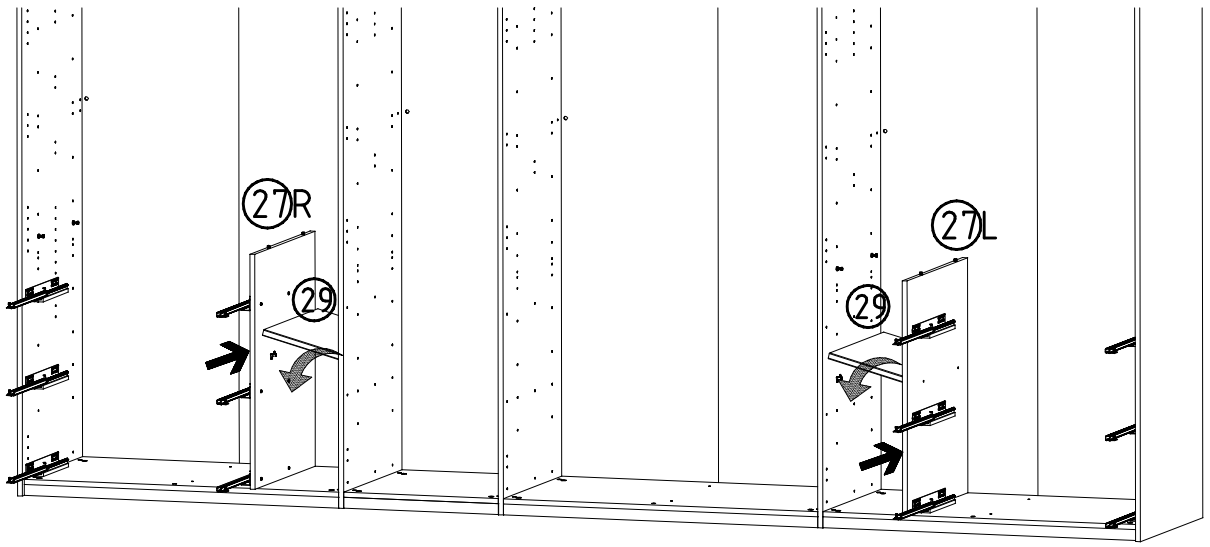

33

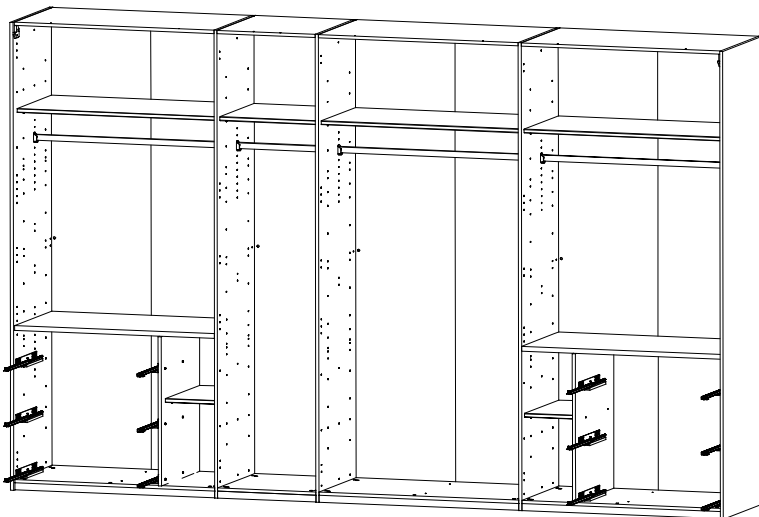
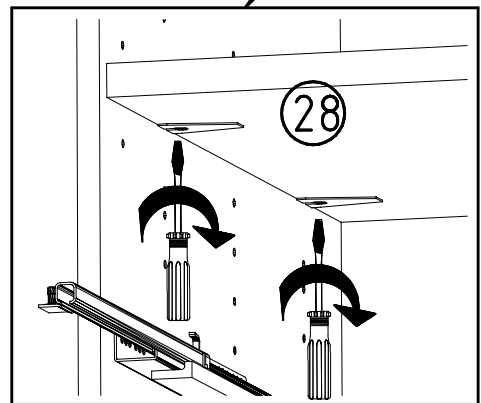
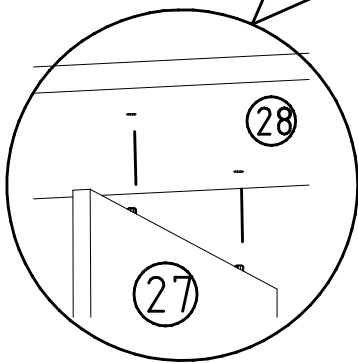
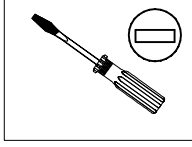
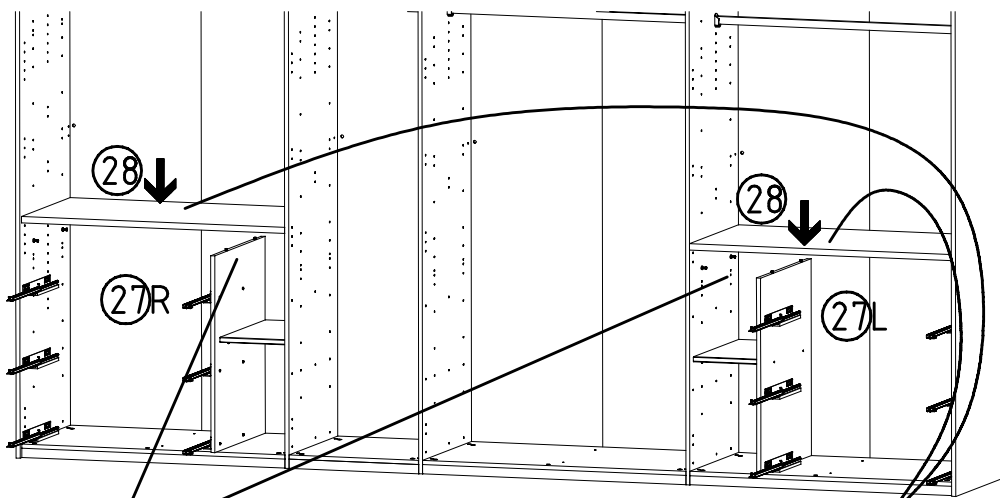

34

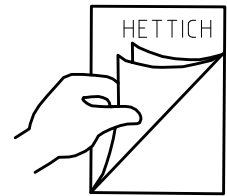
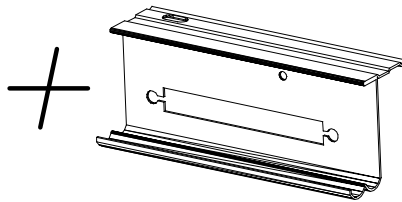
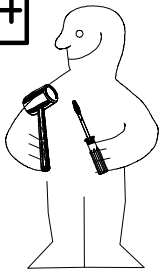

35

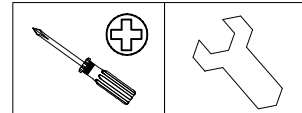
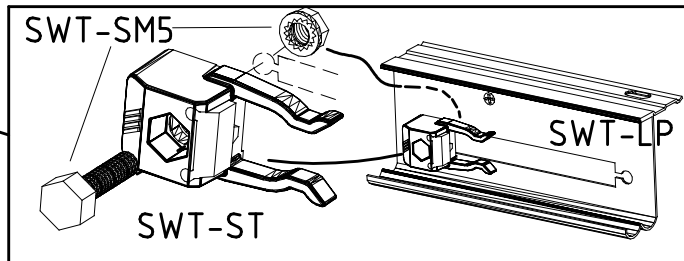
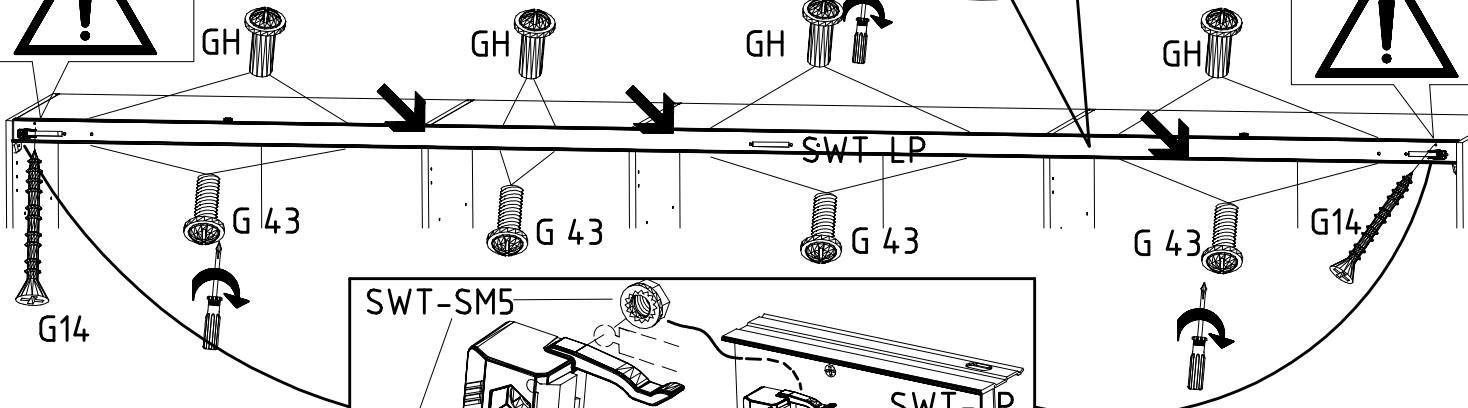
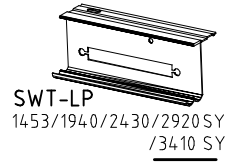
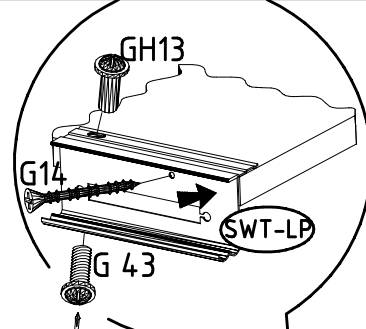
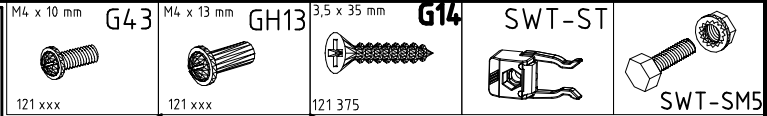
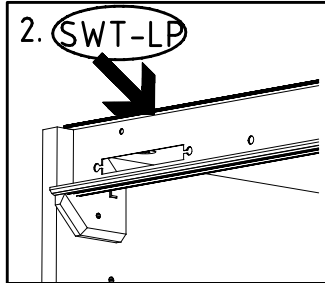
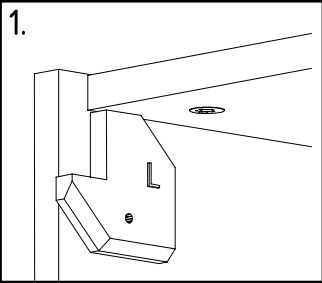

36

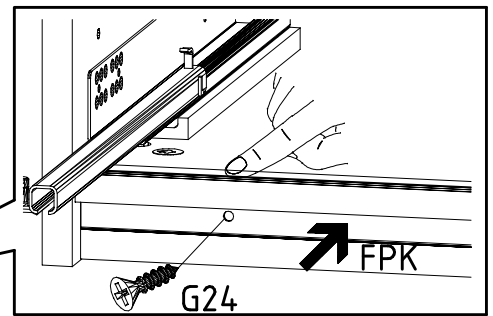
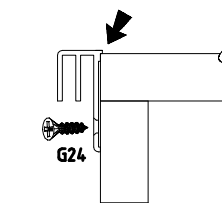
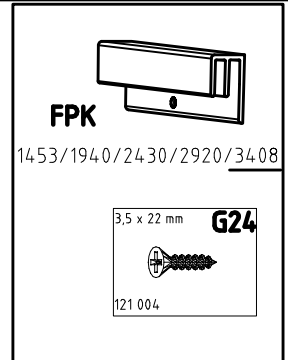
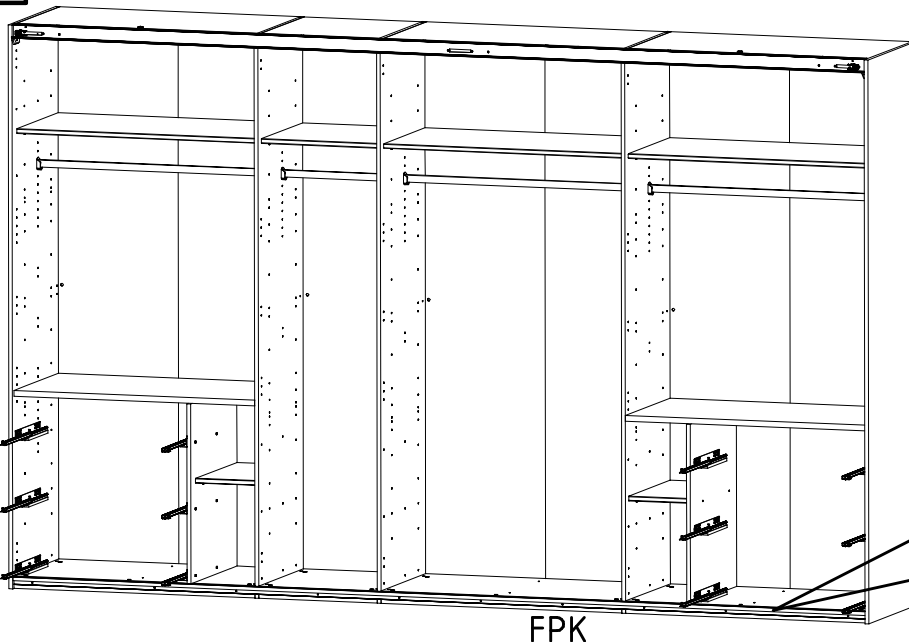

37

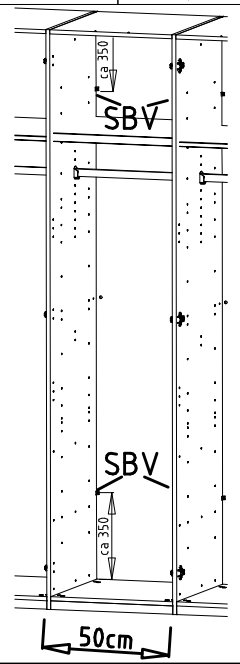
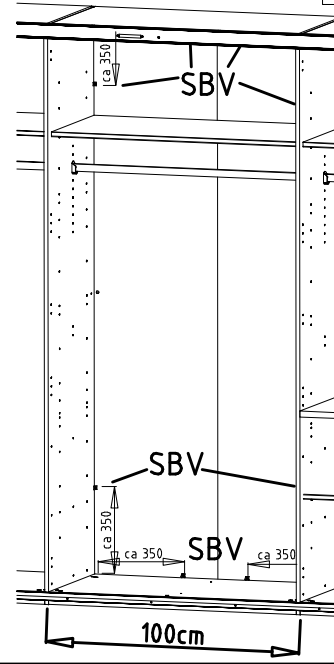
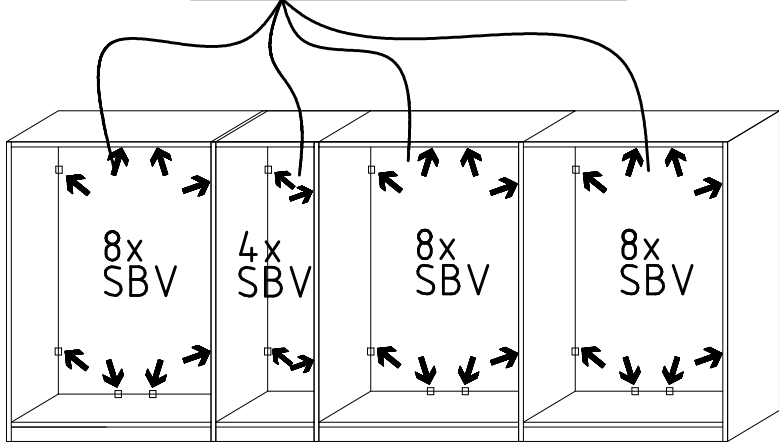
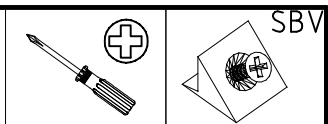
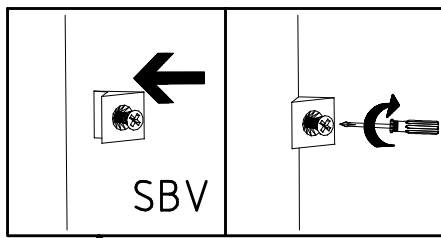

38

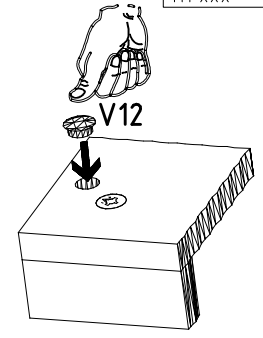
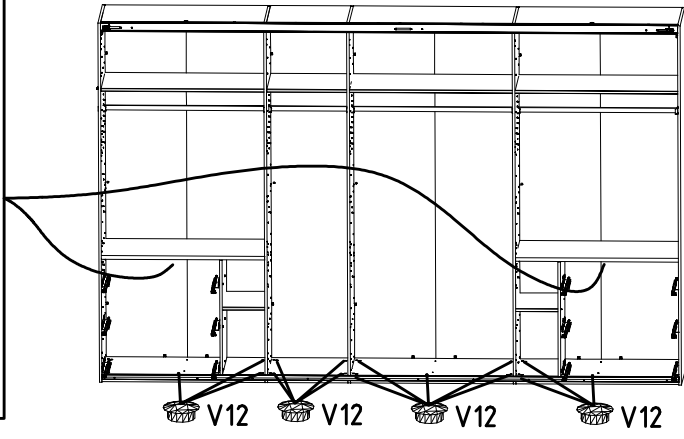
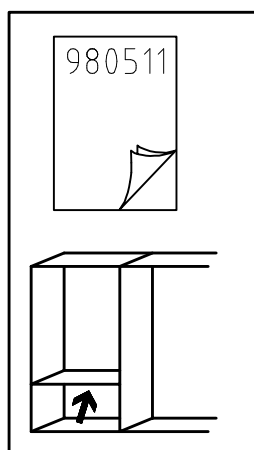

39

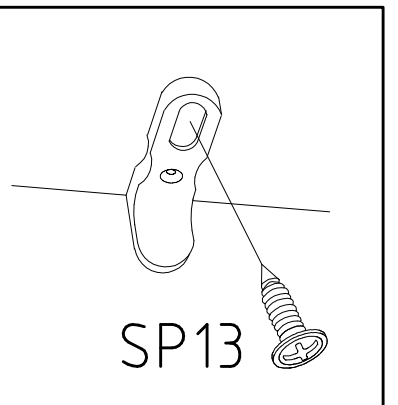
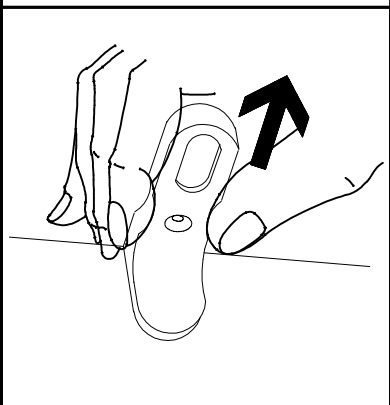
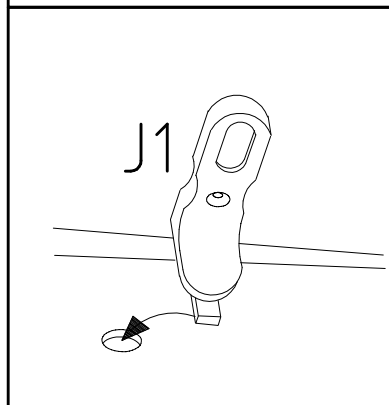
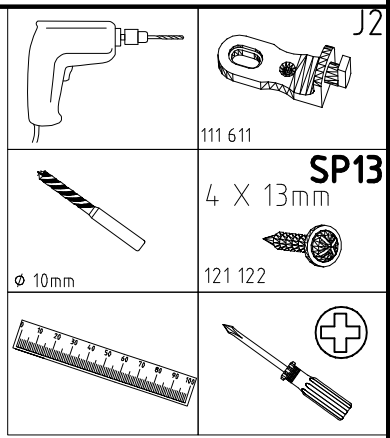
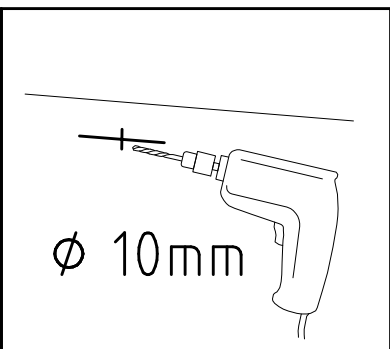
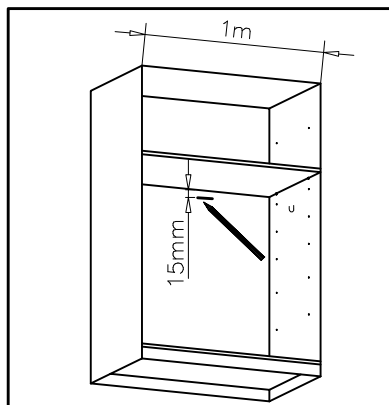

40

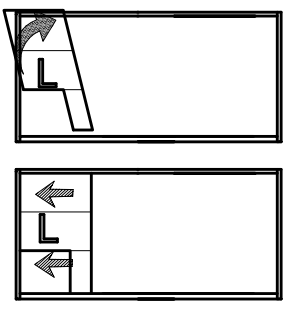

41

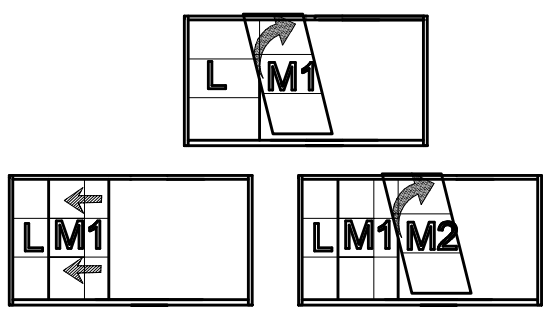

42

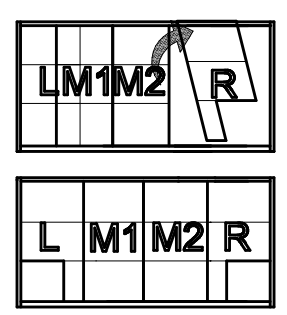

40 + 42

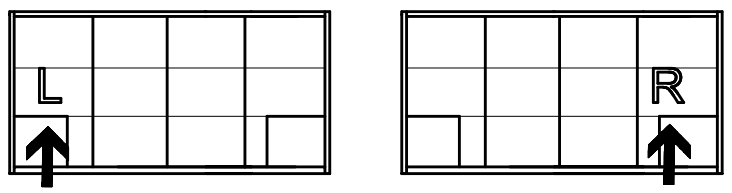

41

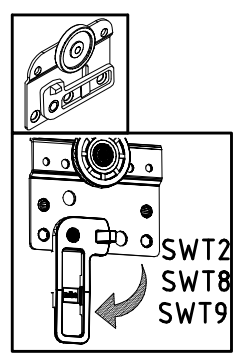
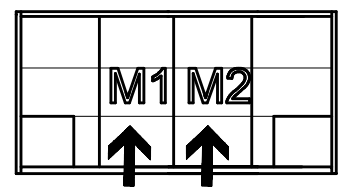

I.

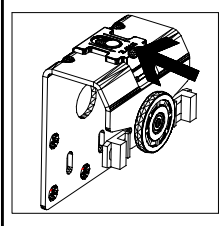
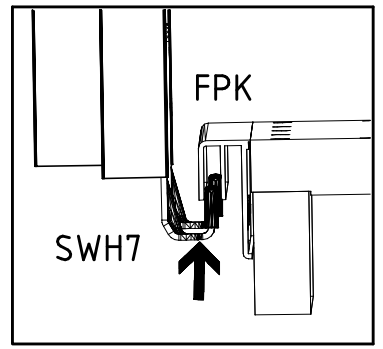

I.

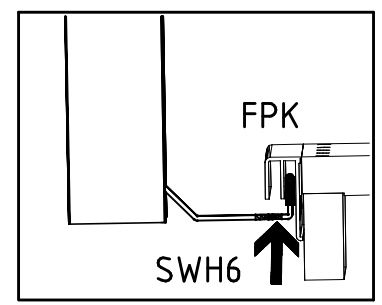

II.

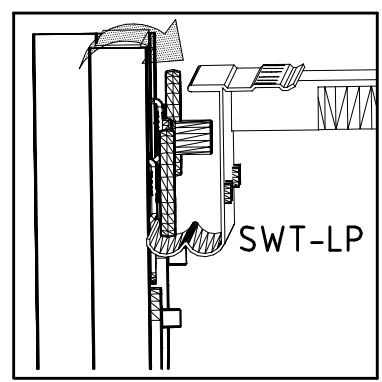

II.

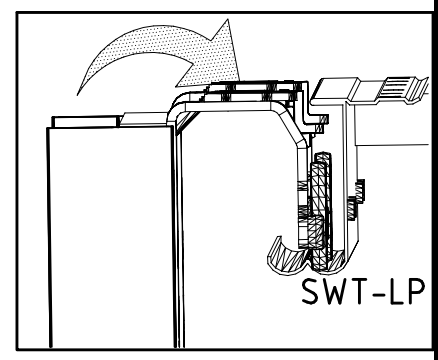

III.

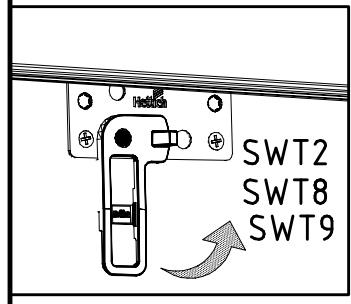

III.

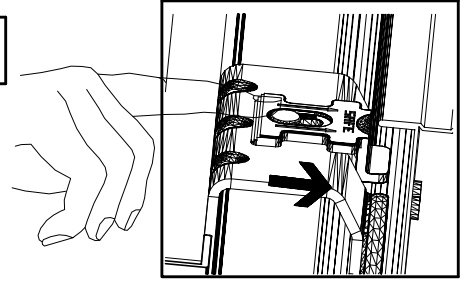
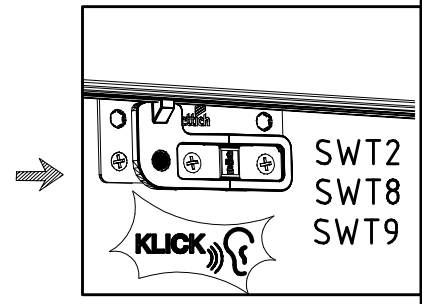

43

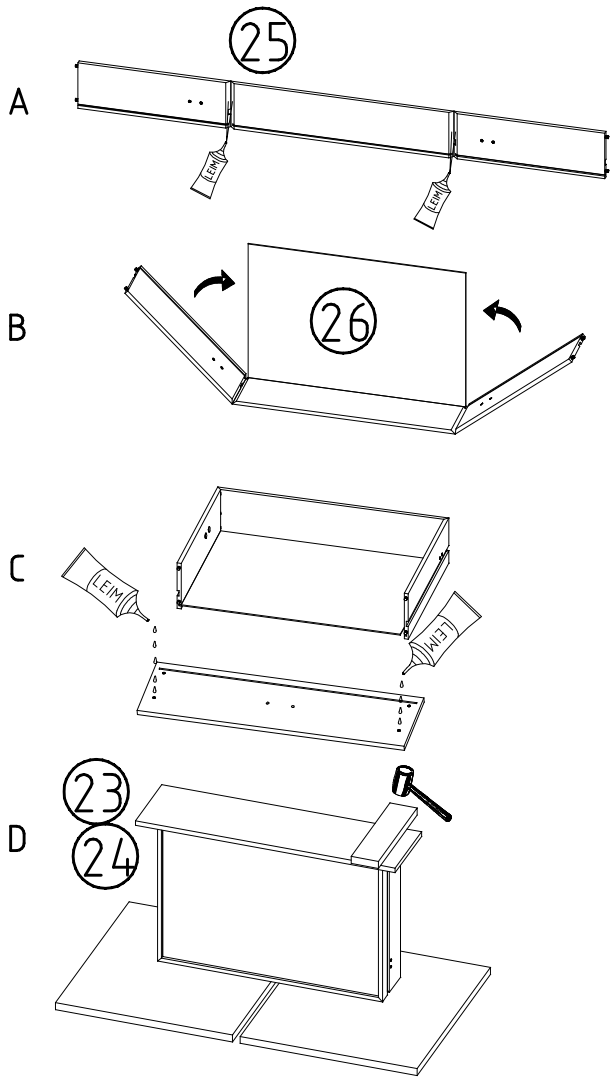
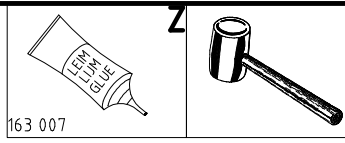

45

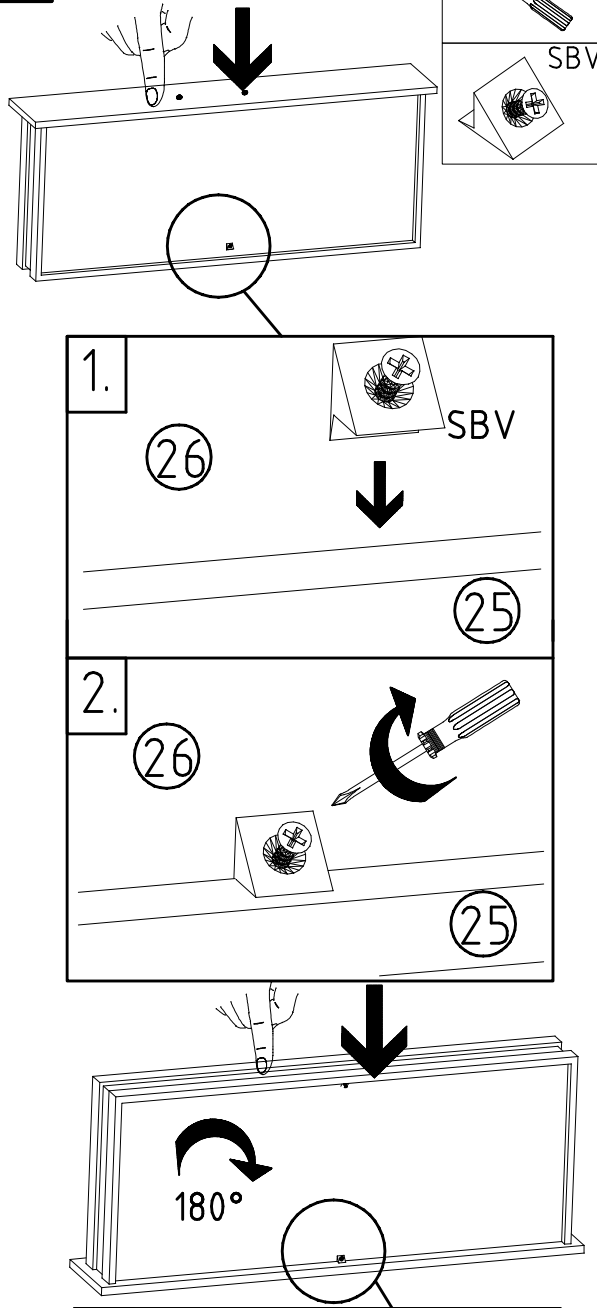
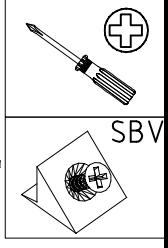

44

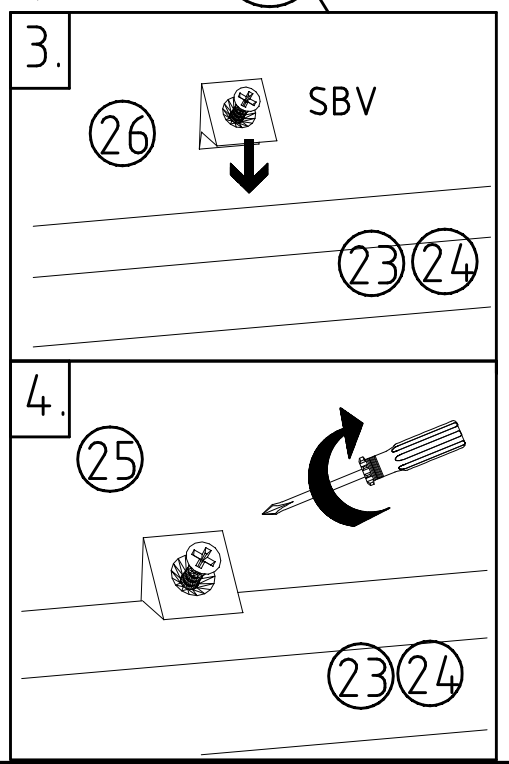
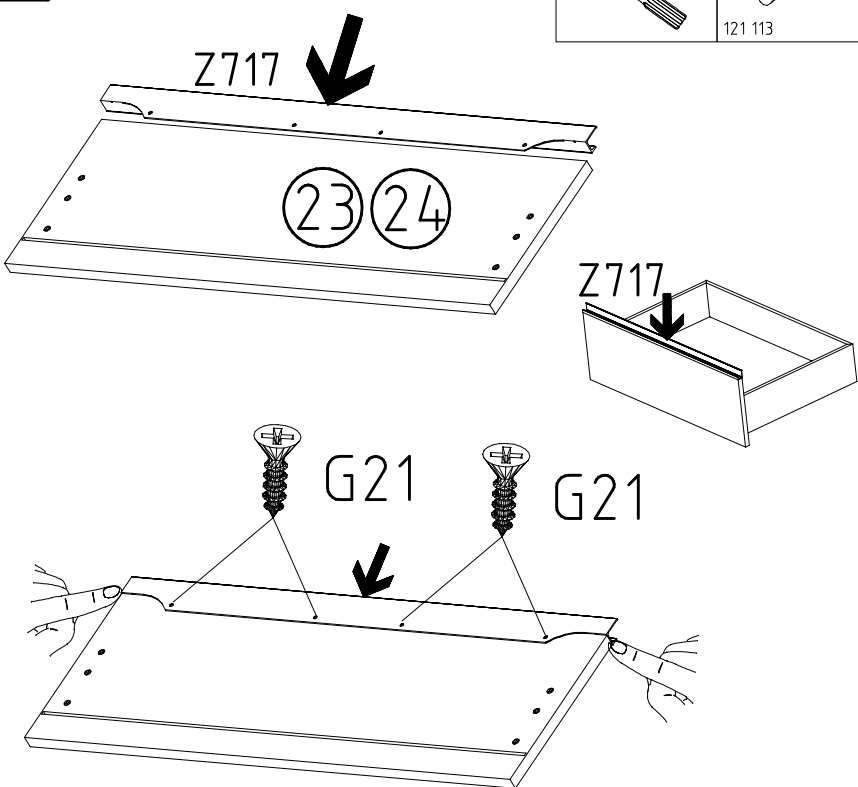
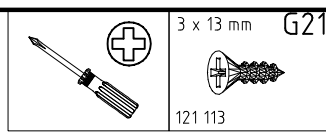

46

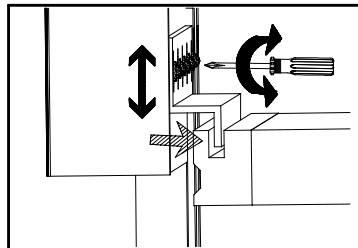
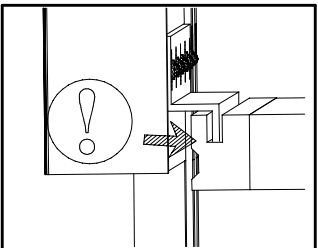
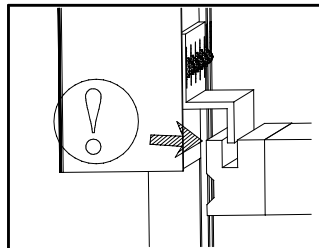
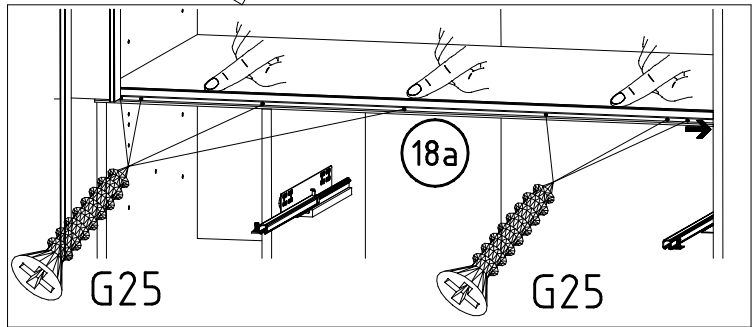
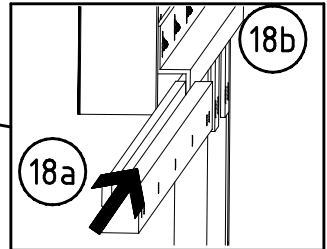
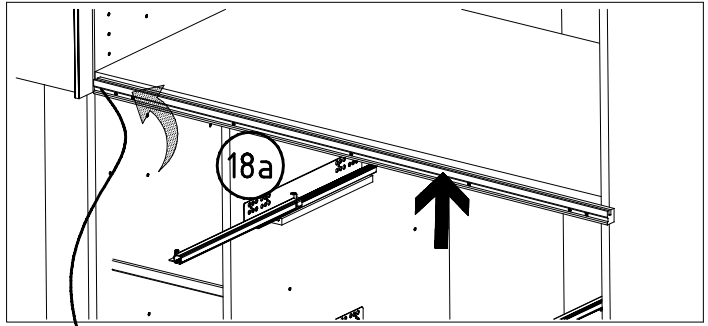
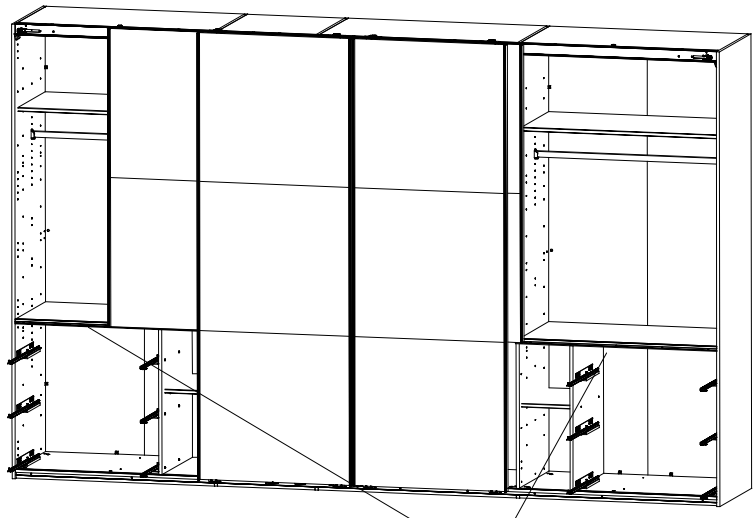
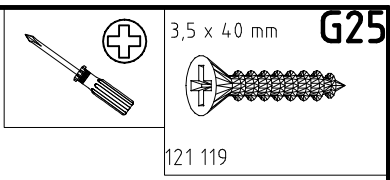

47

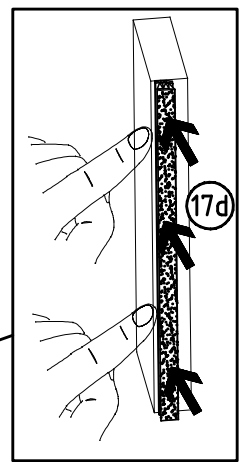
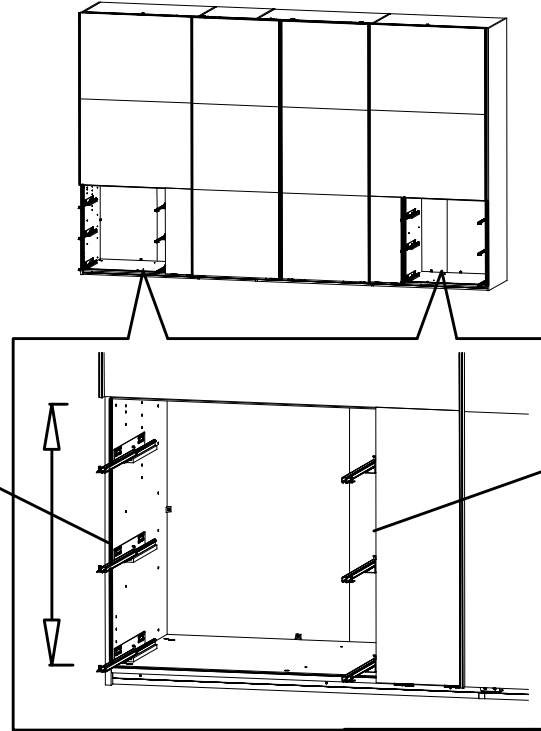
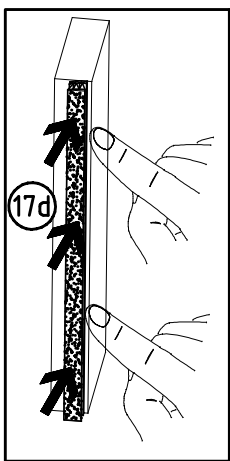
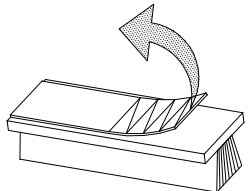
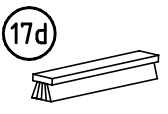

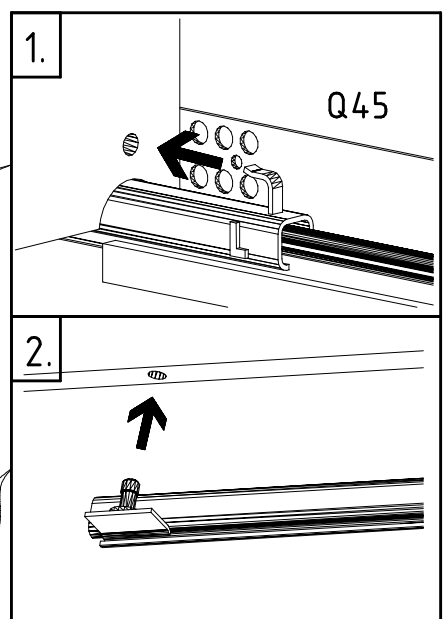
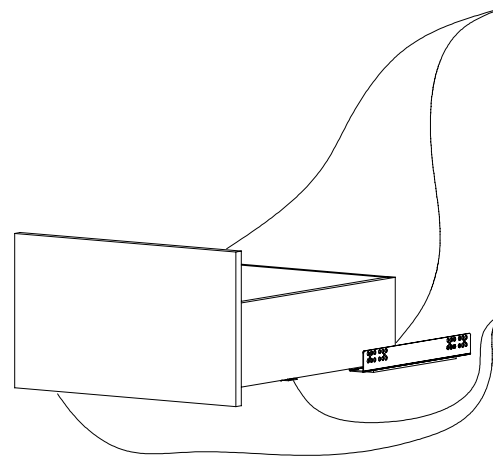
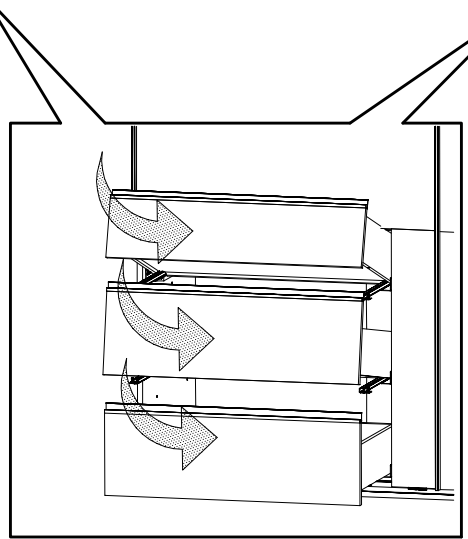
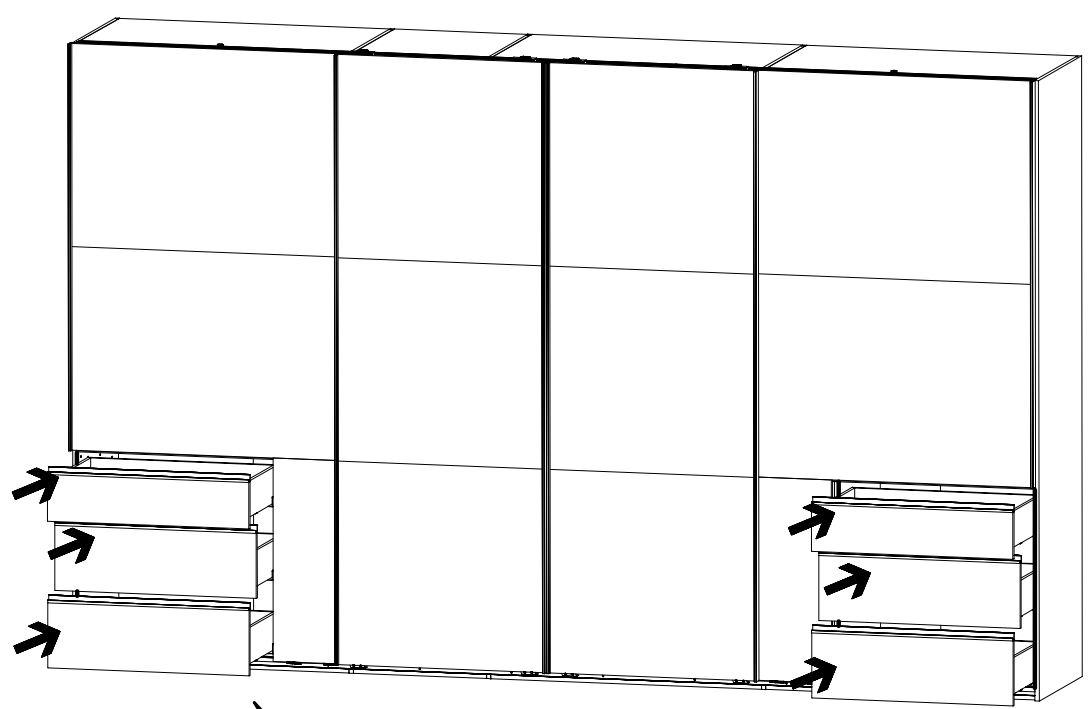

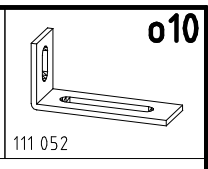
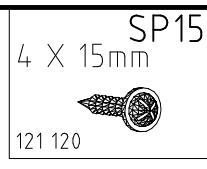
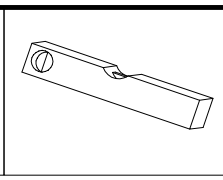
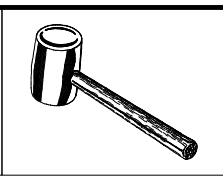
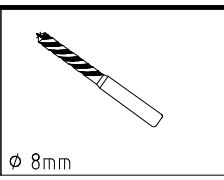
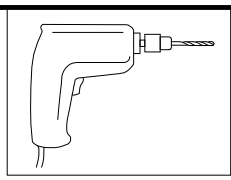

121 120

111 052

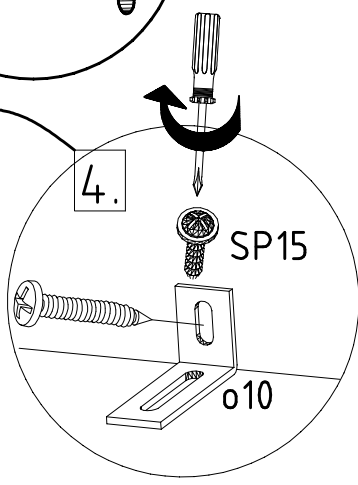
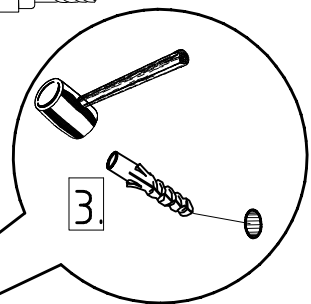
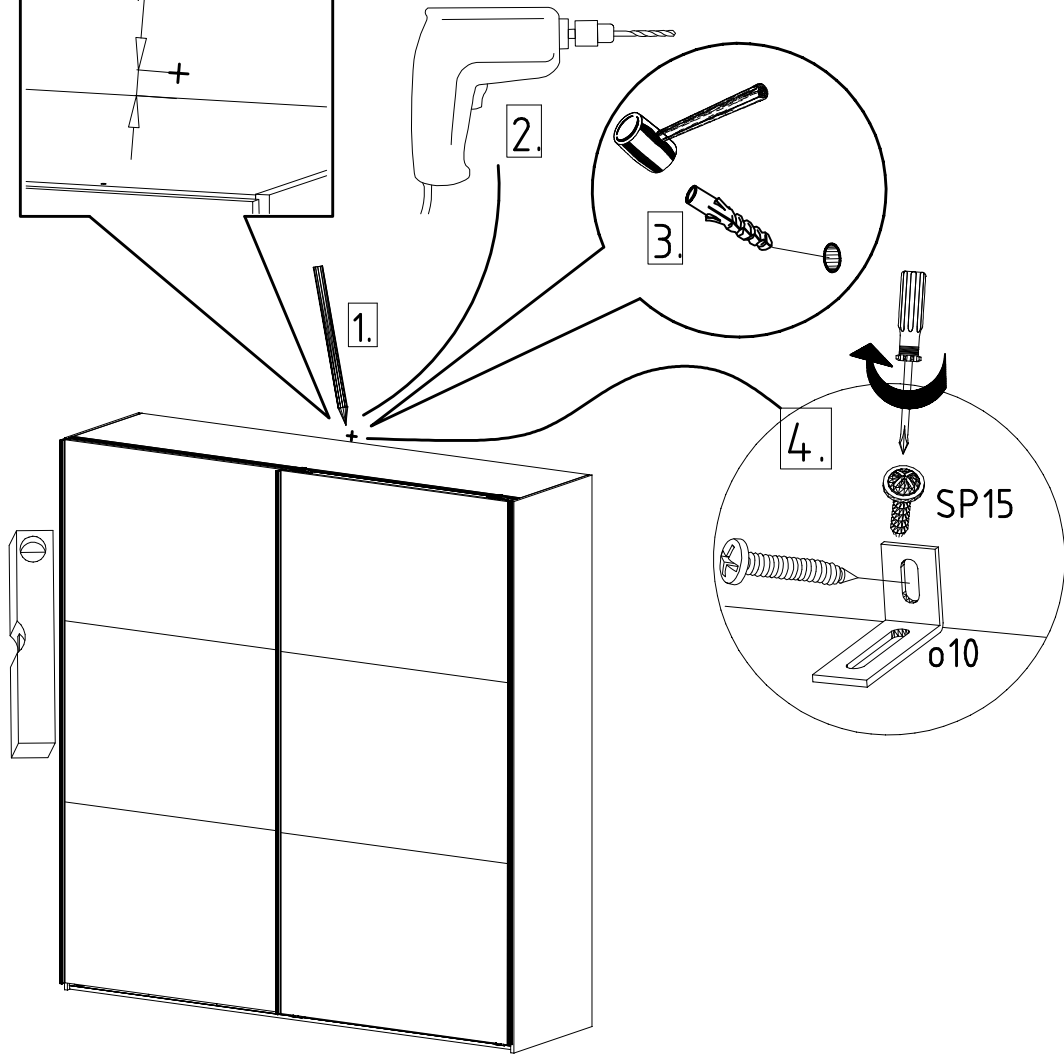
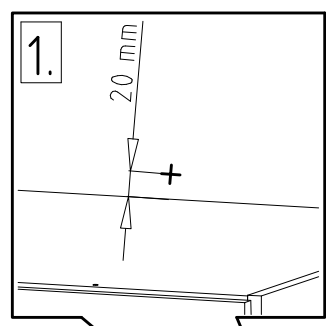
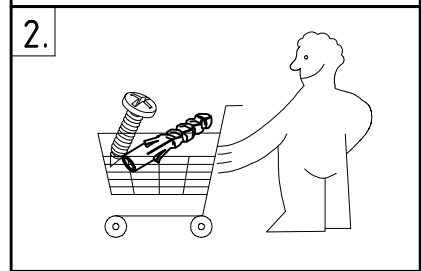
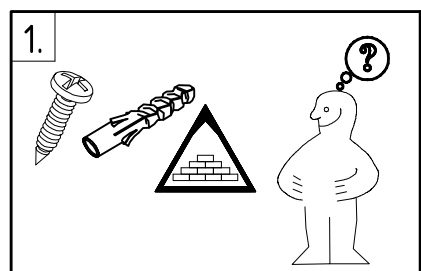





352 302

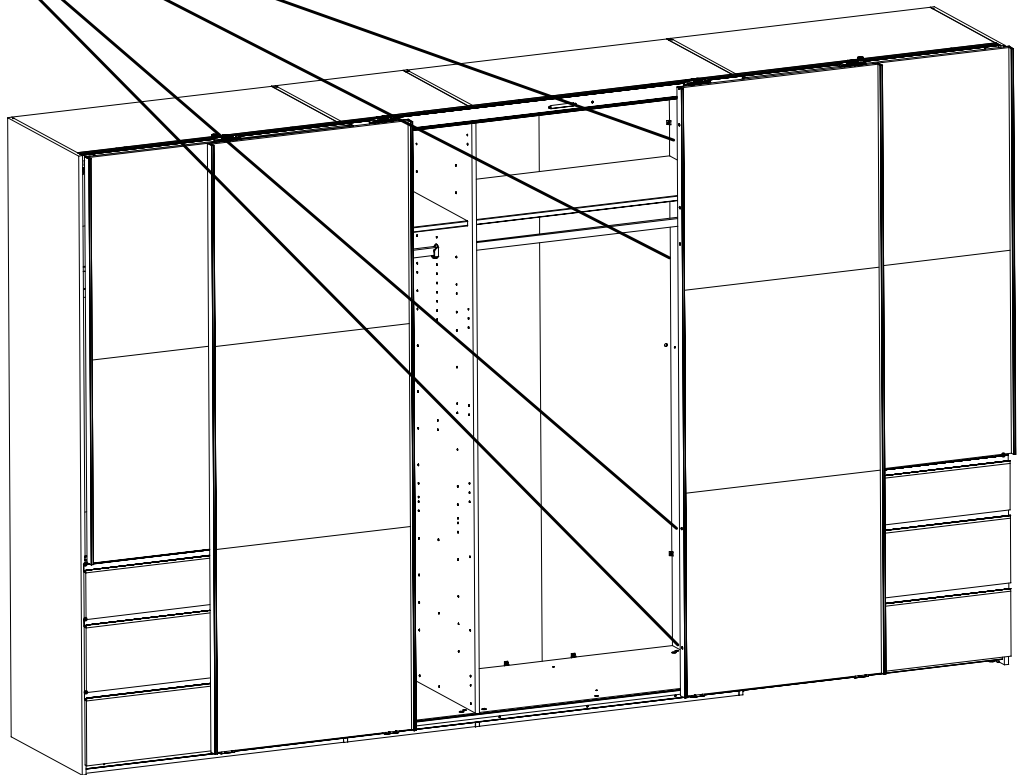
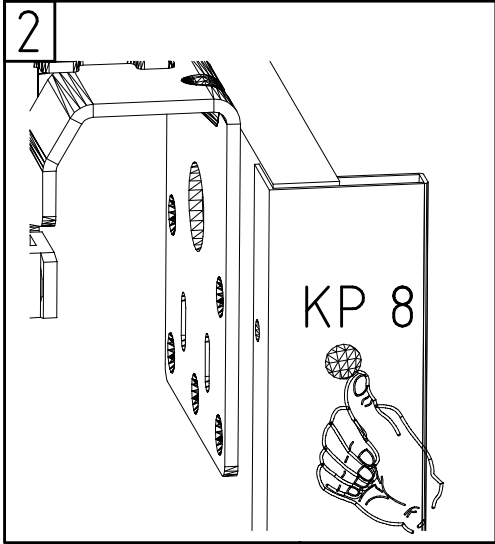
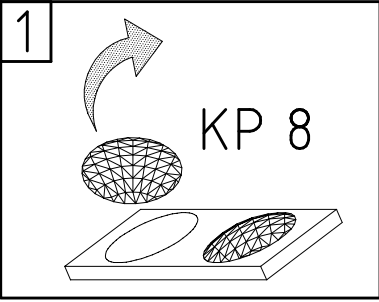

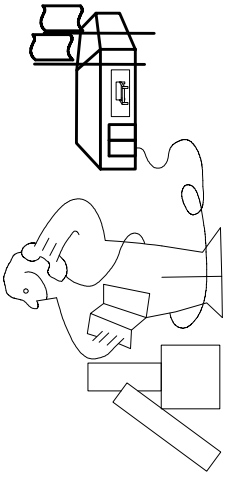
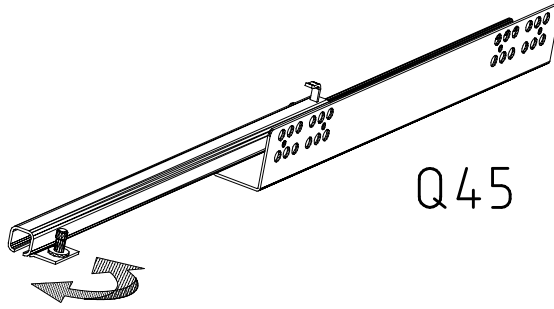
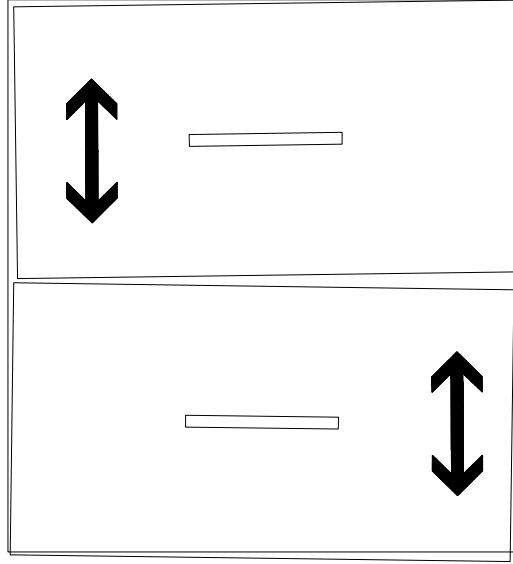

Modell/Model/Modèle

5.

Illustrations of a person reading a manual, a person writing, and a person thinking, with various lines and boxes for notes.

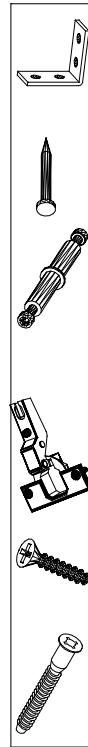

{121 370}	{ G 1 }	{4x}

Änderungen die dem technischen Fortschritt geschuldet sind, behalten wir uns vor!  
 Bei nicht vorschriftsmäßiger und/ oder nicht fachmännischer Montage wird bei Personen- und/ oder Sachschäden keinerlei Haftung übernommen.  
 WIMEX Wohnbedarf/ Import Export Handels GmbH/ Postfach 1407/ 49112 Georgsmarienhütte/ Germany  
 Tel.:(+49) 05401 8598 72 Fax.:(+49) 05401 8598 33 Mail: service\_H@wimex-online.com

104P-Nr. / 104P-No.    150X-Nr. / 150X-No.    Auftrag/Order-No. / No. de Commande

**23203**    **30110XY**    104

Kunde    MAX MUSTERMANN  
Customer  
Client

Kommission / your order reference / votre reference

**3377 MINDEN**

---

Dekor / Decor    Decor / Modell / Modele

**F99**    **SAMPLE**

F99842 SCHWEBETUERENSCHRANK 250 CM H 216CM  
PLANKENEICHE NB + RAU STEEL  
PLANKENEICHE NACHBILDUNG

202320301107241476000001

Paket / Package / Paquet

**414760**

SOCKEL

Paket 1 von 8    Colli Kommission 10

HSP-SMT BOD 50 TEXT/TEX SOCKEL 32 FRESH TV / LF  
SO-BOD TEXT RASTEX/ ZNBOD D18MM TX KLSTA 104

Montage - Anleitung    Laenge ..... 520,0    OBEREN  
KS-64    Breite ..... 568,0    OBEREN

**SOCKEL32 KLEB**

En cas de dommage, veuillez retourner le carton avec le produit. / En cas de dommage veuillez retourner le carton avec le produit.



OBEREN 5 30/19 HAUT 23.08.19 OBEREN 1 1. ABOVE OBEREN



**WIMEX Wohnbedarf**  
Import Export Handelsges mbH & Co. KG  
Werner-von-Siemens-Str. 35  
D-49124 Georgsmarienhütte - Germany

**SAMPLE**    **23.08.19**  
Modellname    Produktionsdatum  
Model    Date of manufacture

