

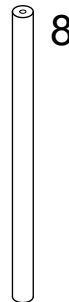

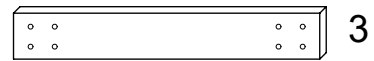

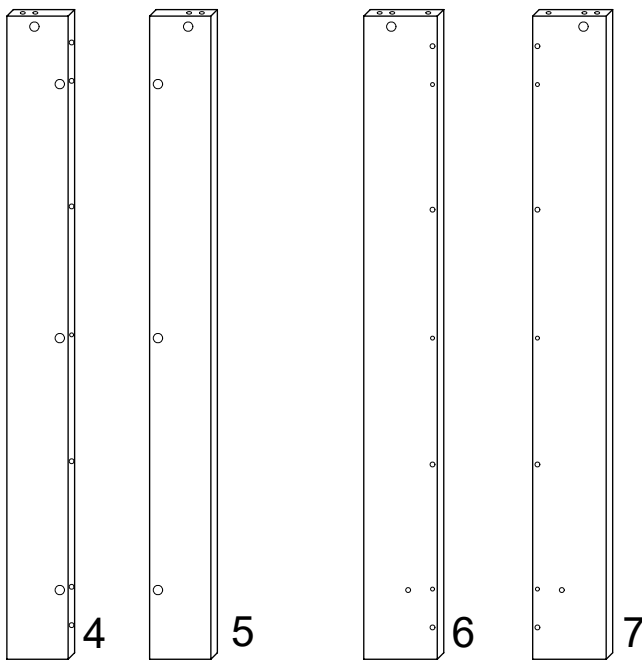

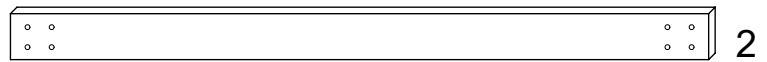

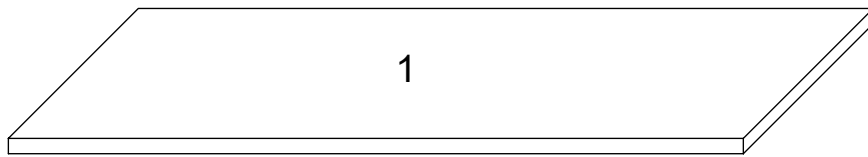
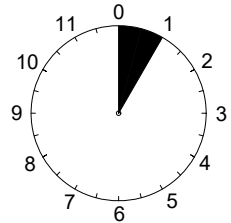
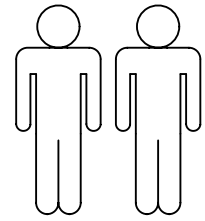
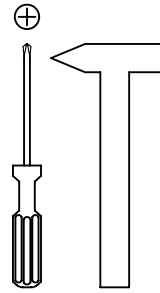
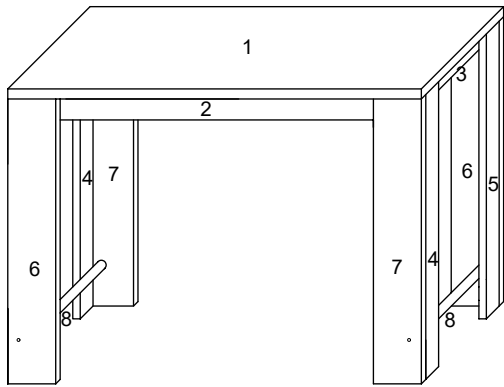
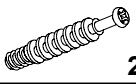

"Frieda" 520/861



1	1 x
2	2 x
3	2 x
4	2 x
5	2 x
6	2 x
7	2 x
8	2 x

A	 20x	B	 20x	C	 8x30	D	 4x35	E	 4x20	F	 2x
G	 D=16mm 12x	H	 12x	J	 L=45 mm 4x	K	 SW 4 1x	L	 2x		

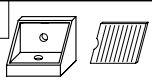
I.

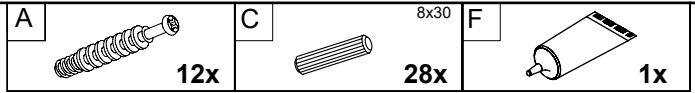

1.

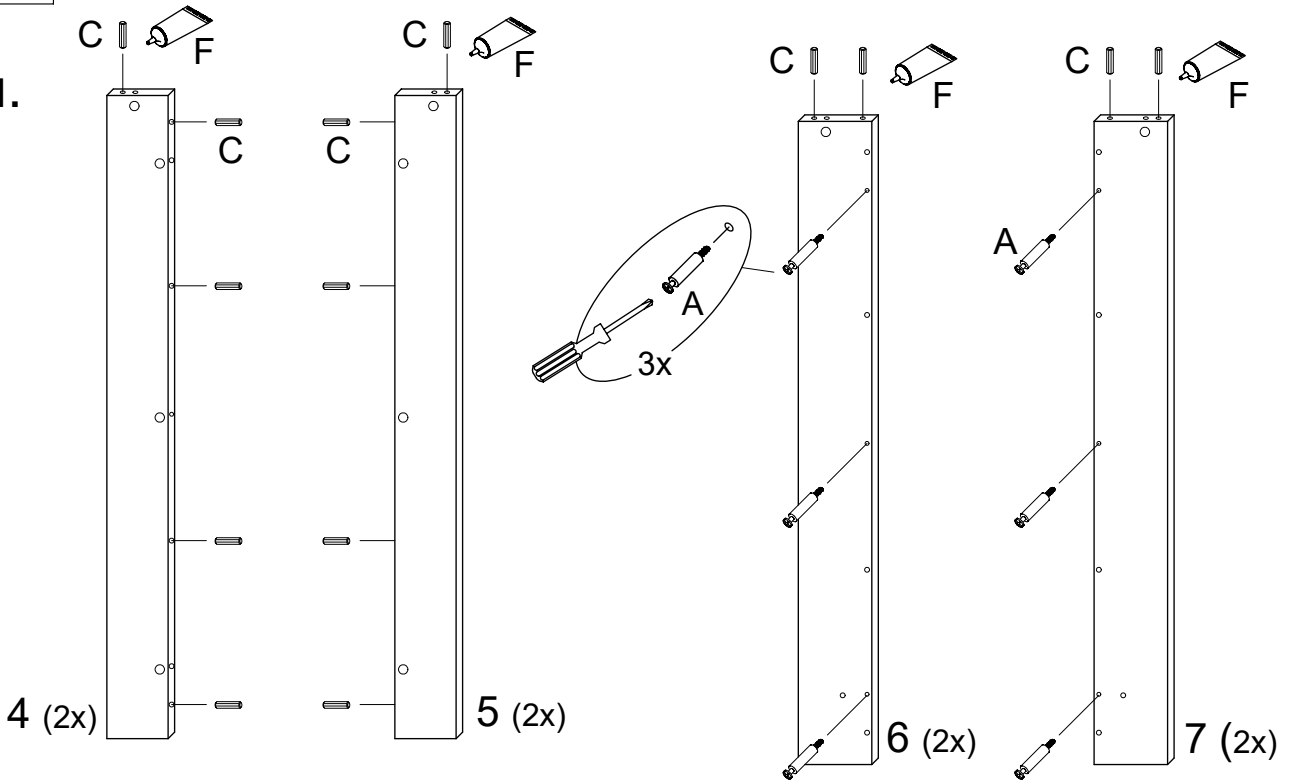

2.

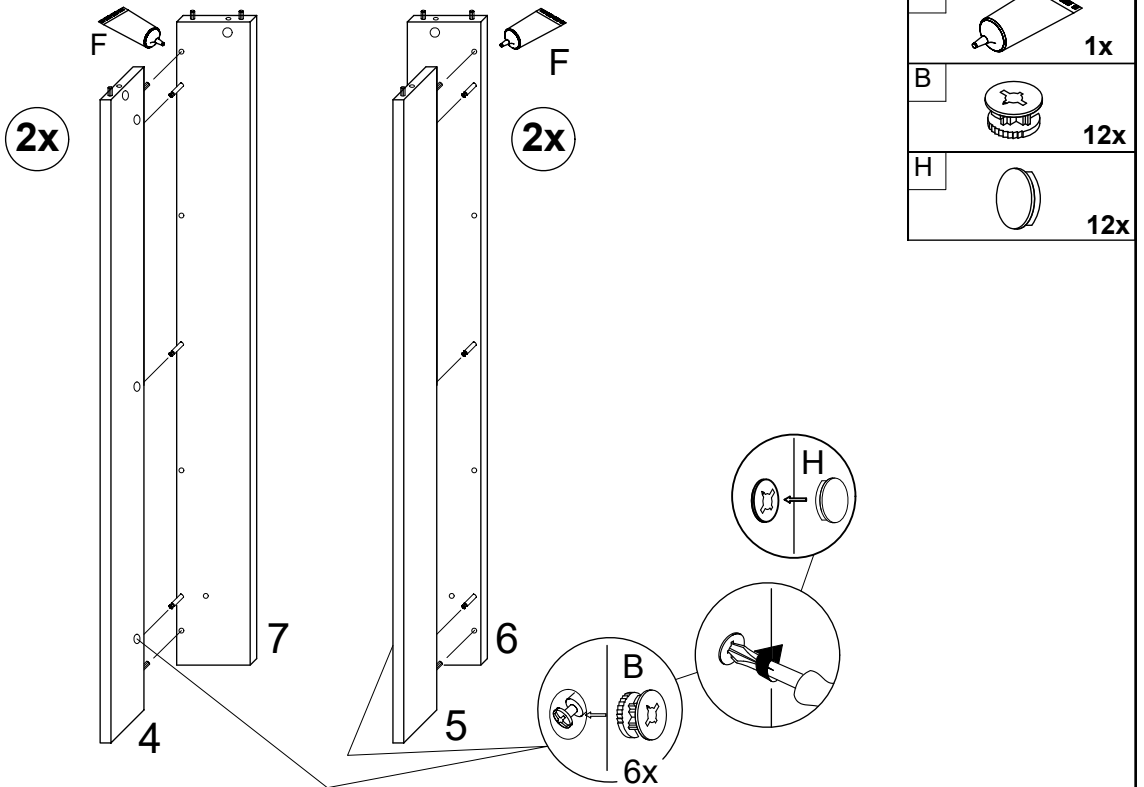



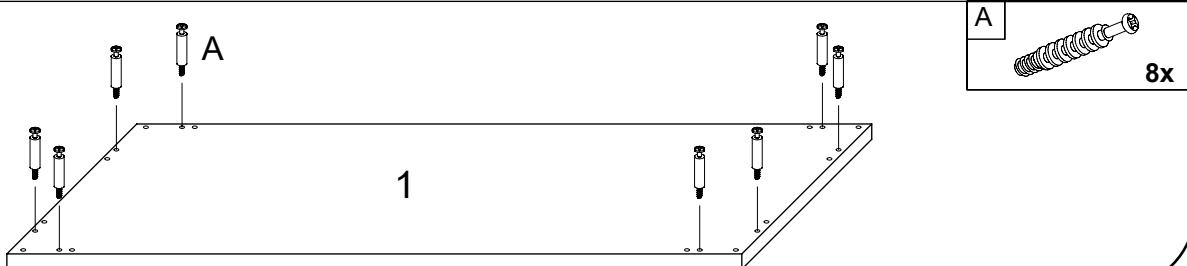

3.

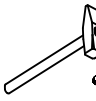

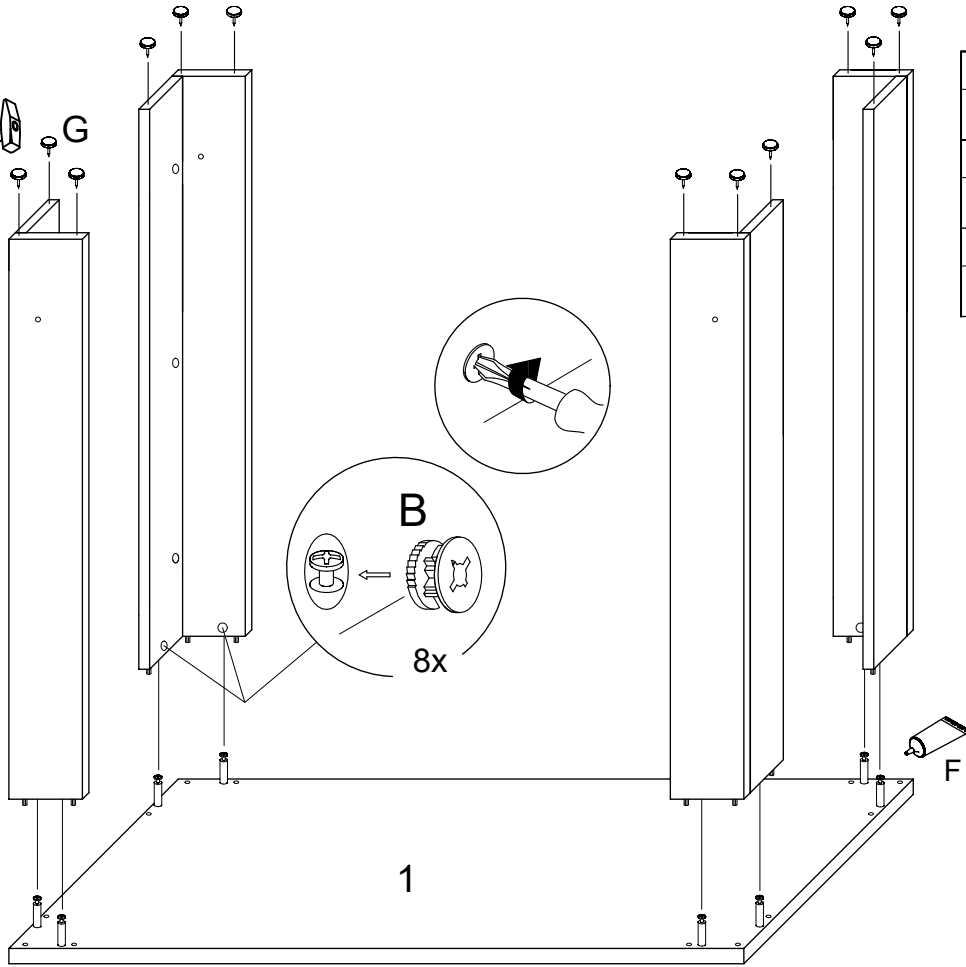
II.





4. 

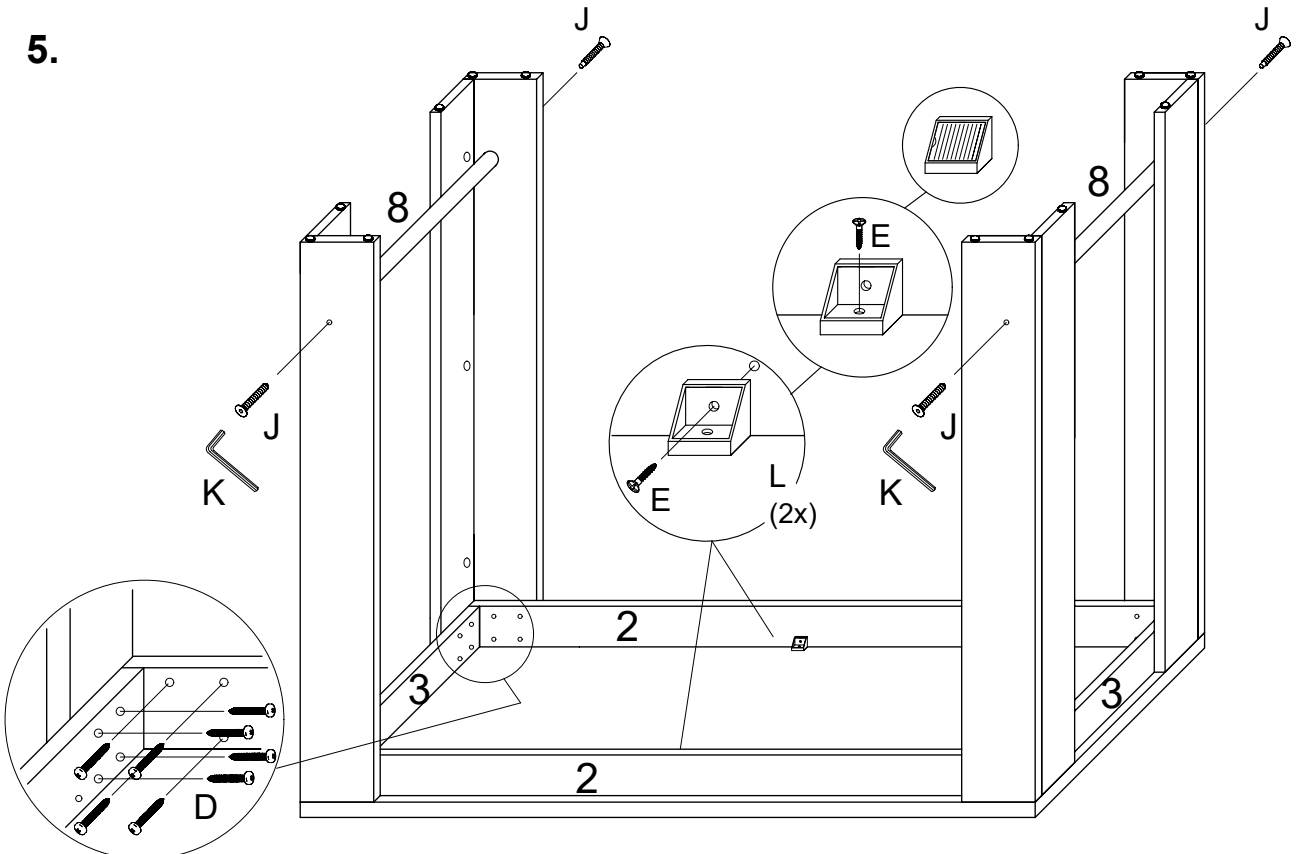

F		1x
B		8x
G		D=16mm 12x

5.



D		4x35	E		4x20	J		L=45 mm	K		SW 4	L		2x
	32x			4x		4x				1x				

III.

6.

