

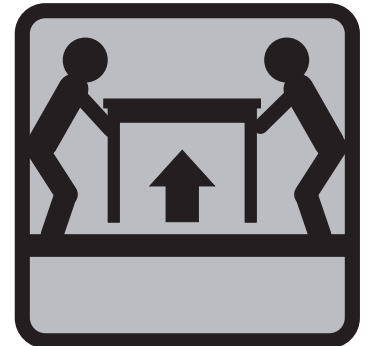

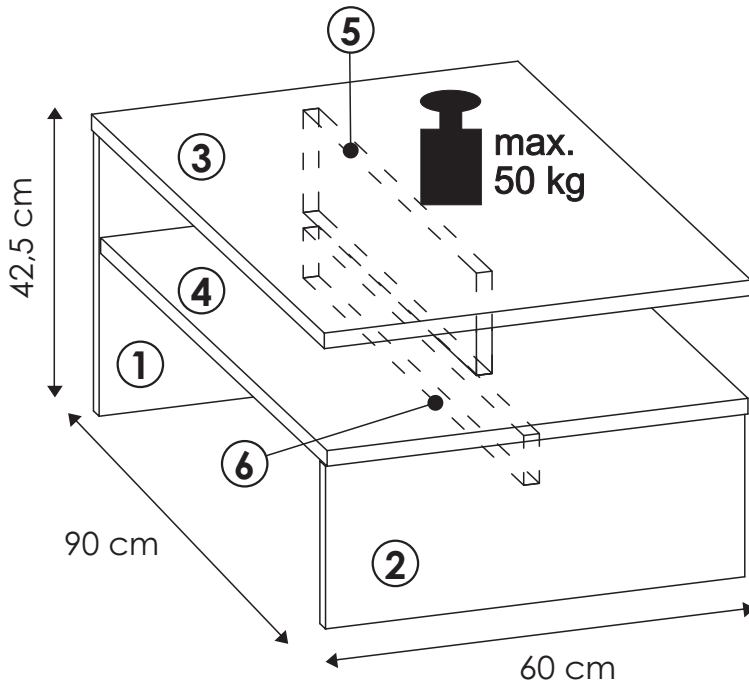



1803

LAURA LRT01

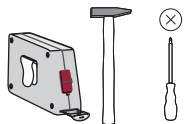

- | | | | | | |
|--|---|---|--|--|---|
| a1

8x35
x....(x19) | e0

x...(x13) | e1

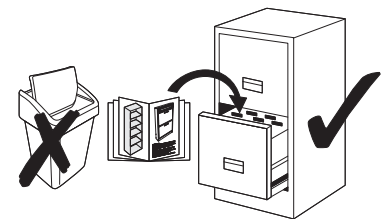
x...(x13) | f1

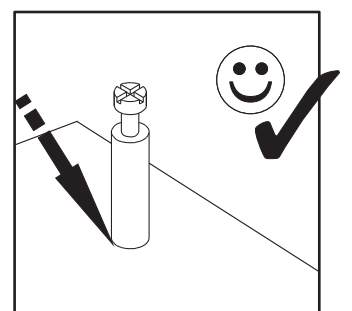
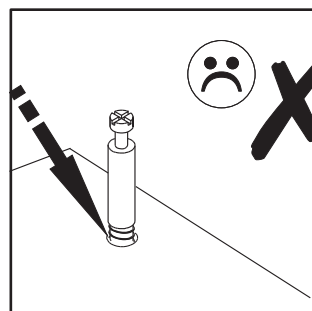
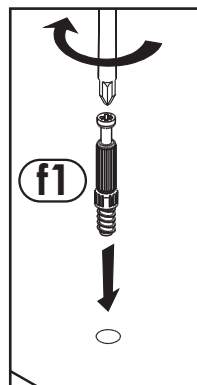
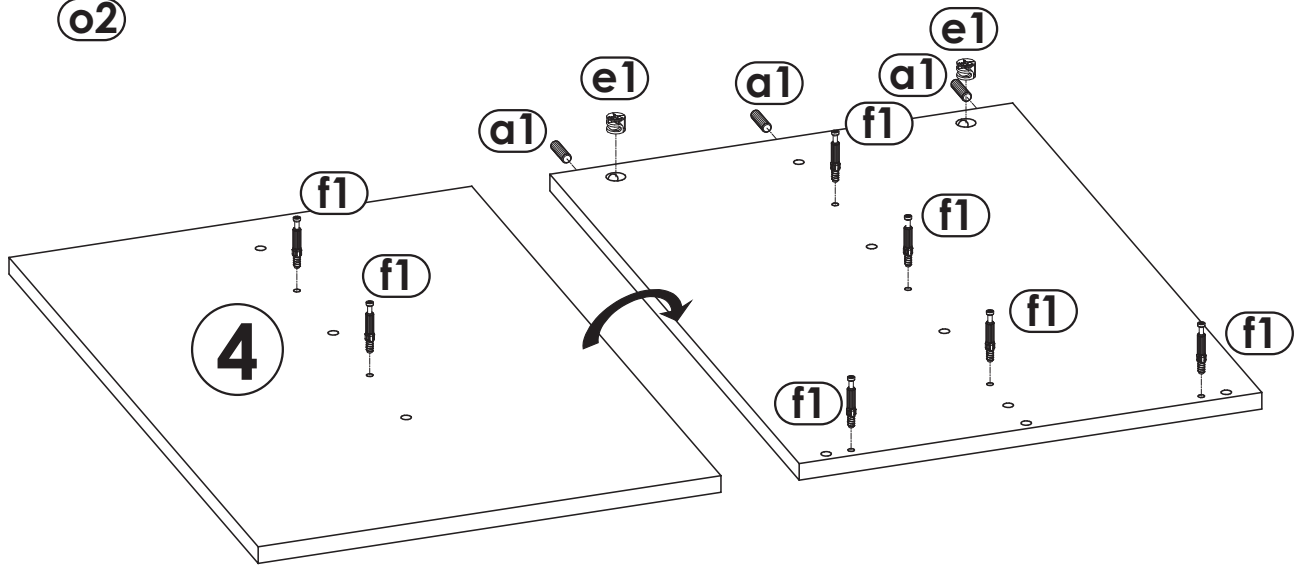
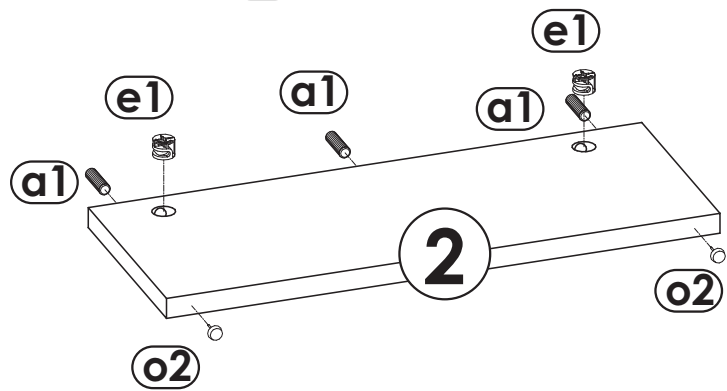
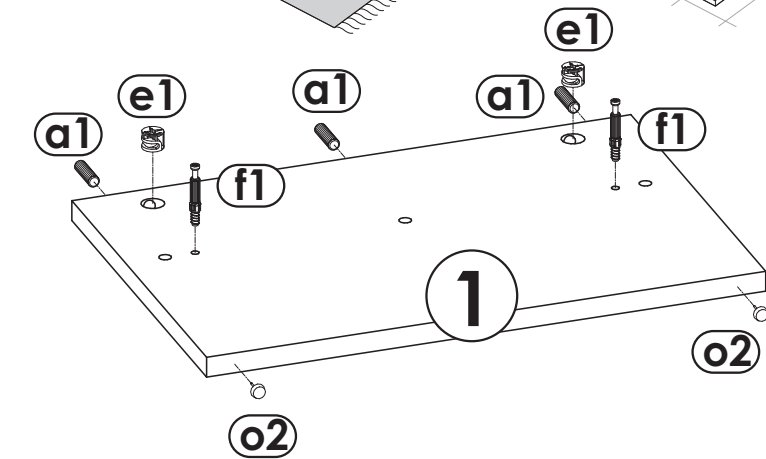
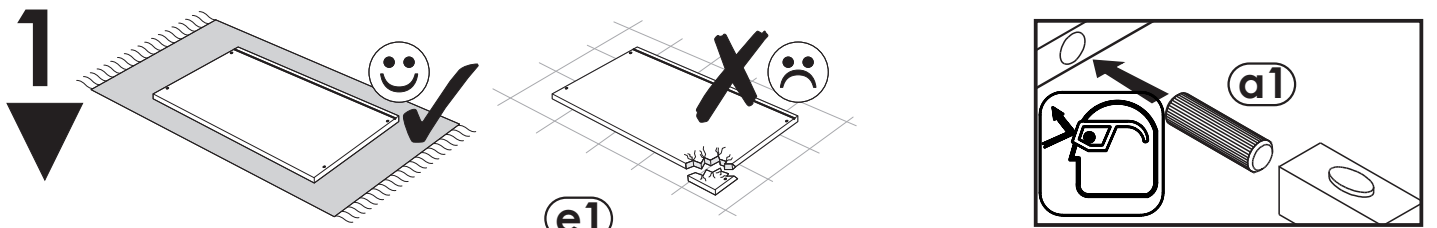
x..(x13) | m

x....(x1) | o2

x....(x4) |
|--|---|---|--|--|---|



- 30 min.





2

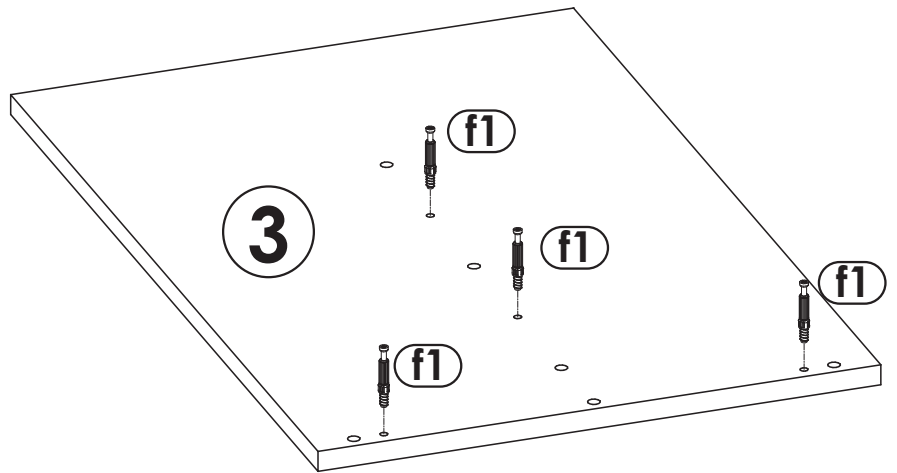
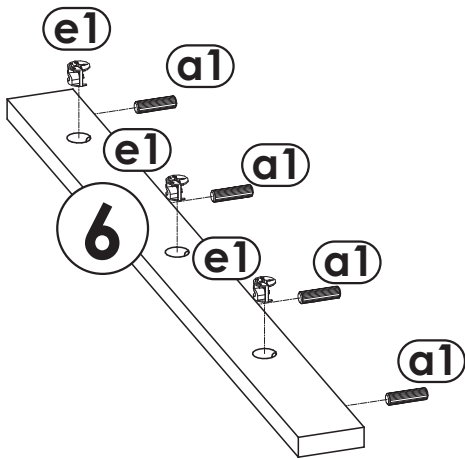
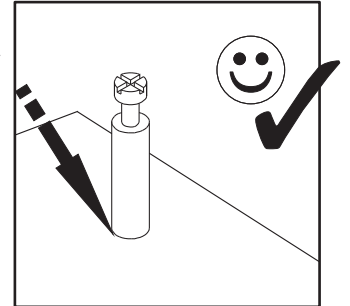
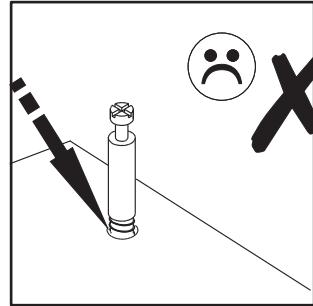
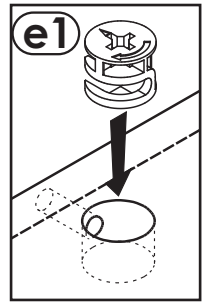
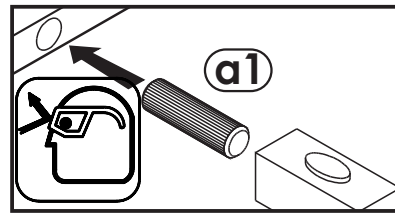
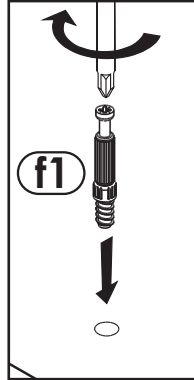
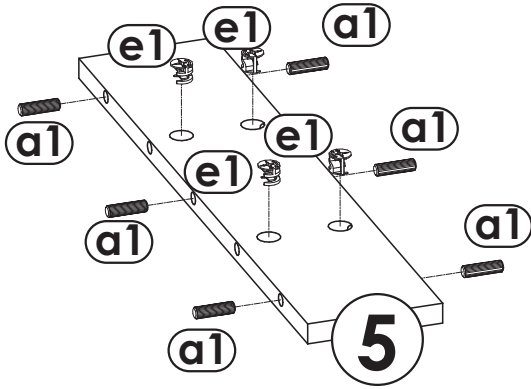
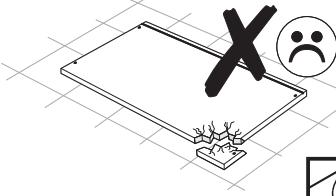
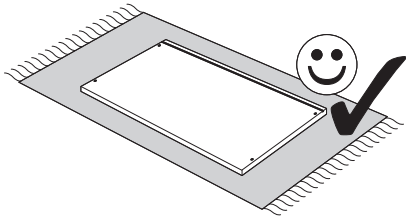

3

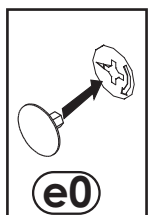
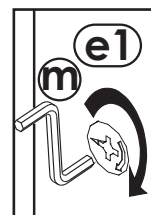
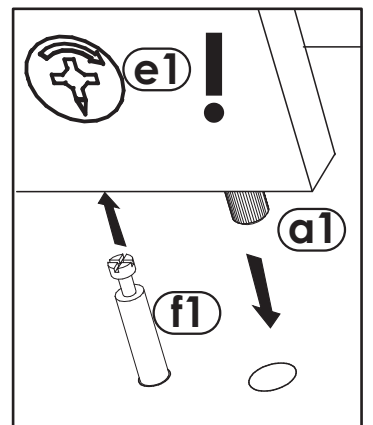
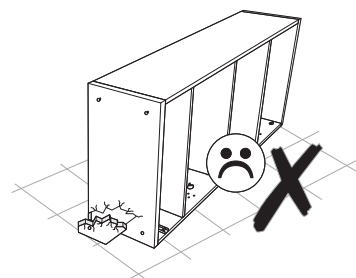
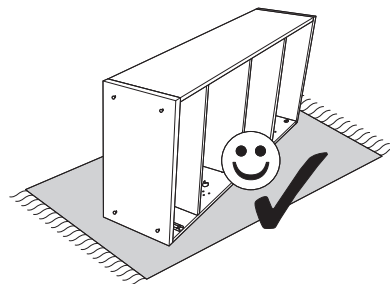
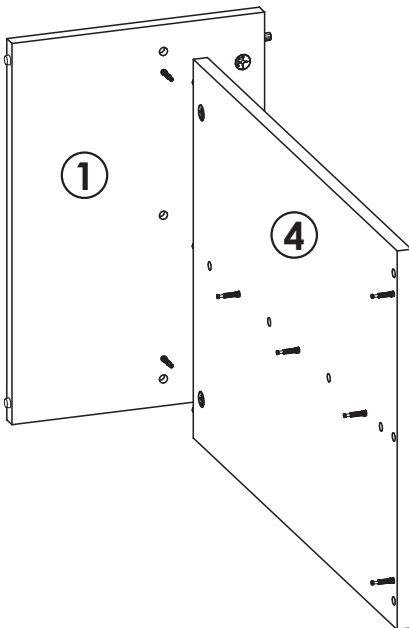

4

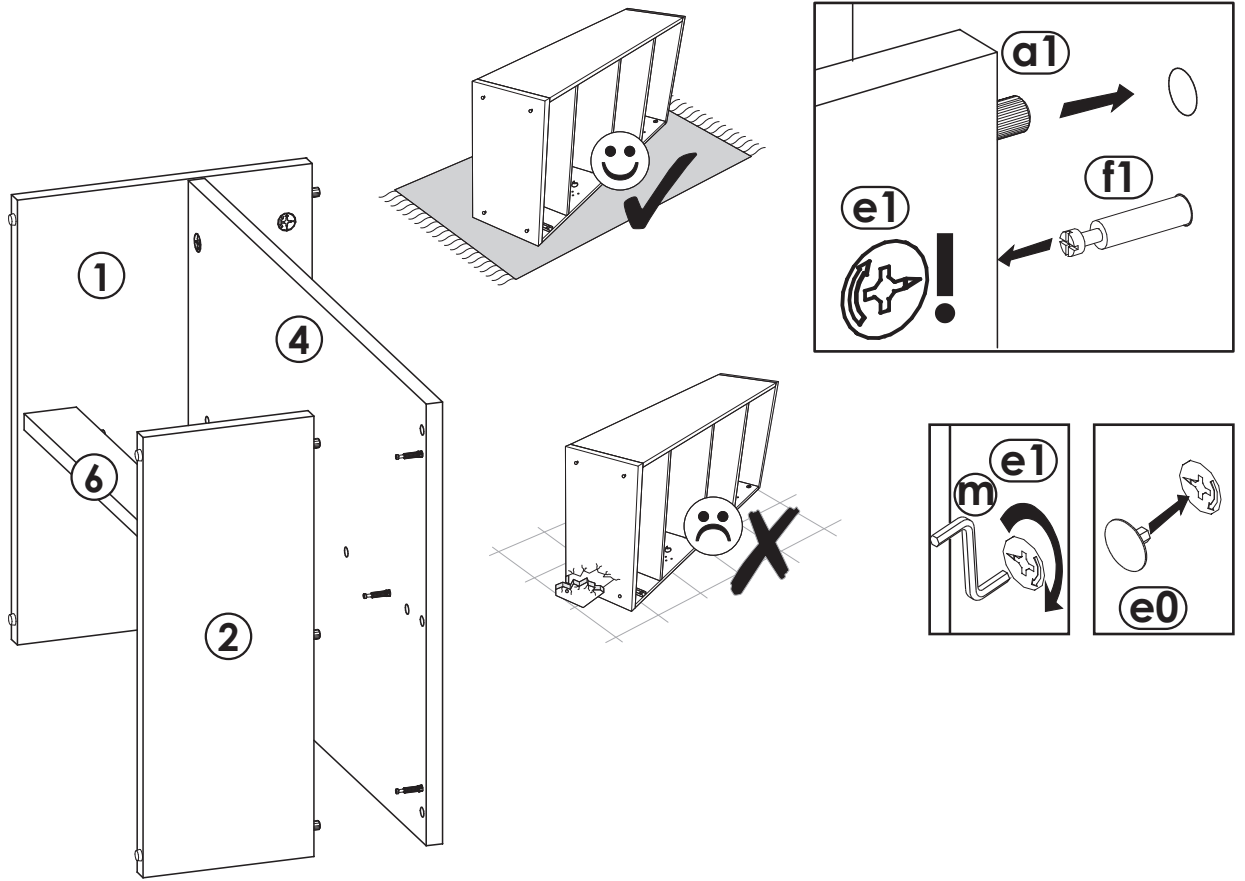

5

