

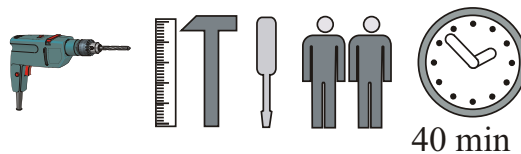

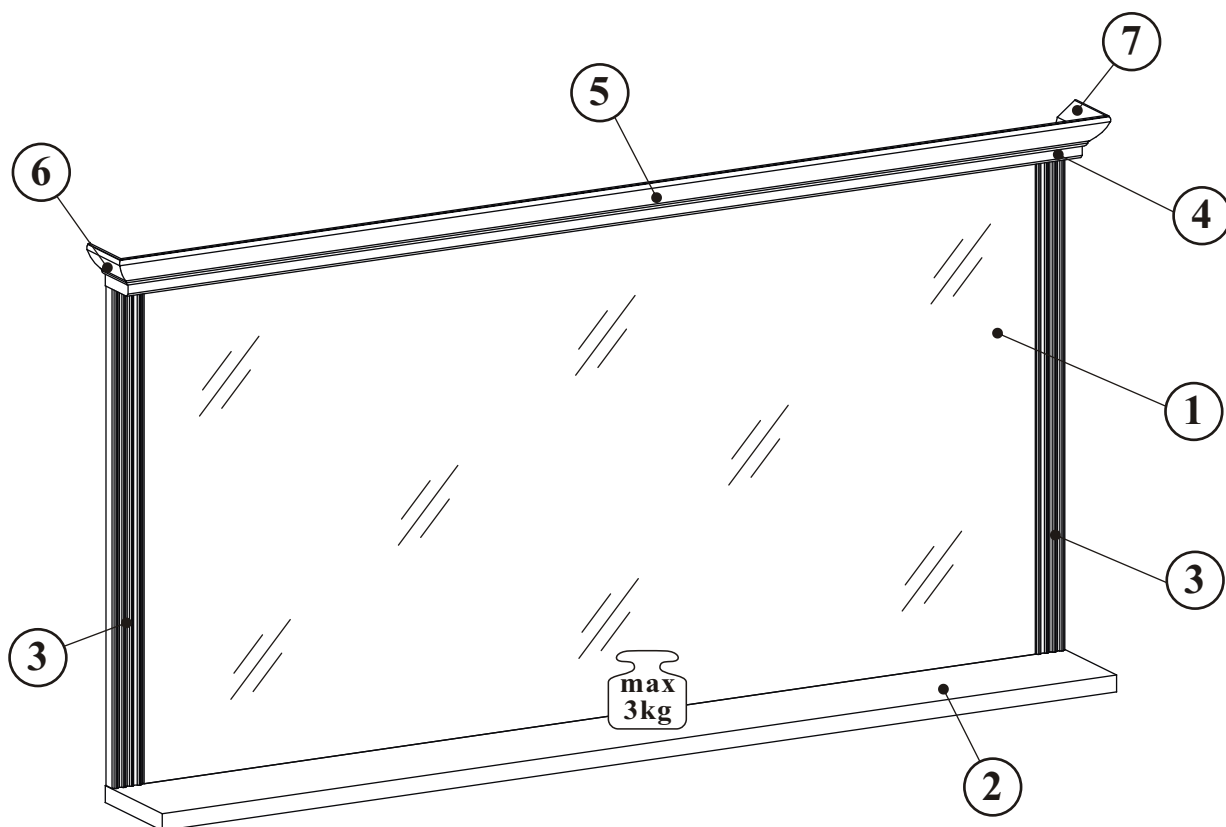

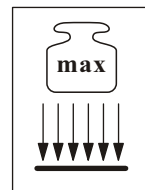



# JASMIN 10G9\_50

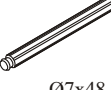

40 min

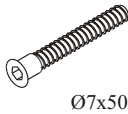
| NO | Dim. |     |    | Col.-No | Qty |
|----|------|-----|----|---------|-----|
|    |      |     |    |         |     |
| 1  | 1272 | 650 | 19 | 1       | 1   |
| 2  | 1360 | 150 | 22 | 1       | 1   |
| 3  | 650  | 43  | 19 | 1       | 2   |
| 4  | 1360 | 60  | 16 | 1       | 1   |
| 5  | 1413 | 67  | 22 | 1       | 1   |
| 6  | 86   | 67  | 22 | 1       | 1   |
| 7  | 86   | 67  | 22 | 1       | 1   |

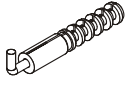
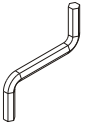
|  |  |  |   |  |  |
|--|--|--|---|--|--|
| A1<br>x8<br><br>ø8x36   | A3<br>x4<br><br>ø8x47 | B5<br>x12<br><br>ø15x12     | G5<br>x12<br>  | B9<br>x6<br><br>ø7x48 | D9<br>x8<br><br>USØ3x20 |
| B11<br>x12<br><br>ø7x50 | G4<br>x12<br>         | D20<br>x6<br><br>ESØ6,3x9,5 | KR2<br>x3<br> | G2<br>x1<br>          |  |

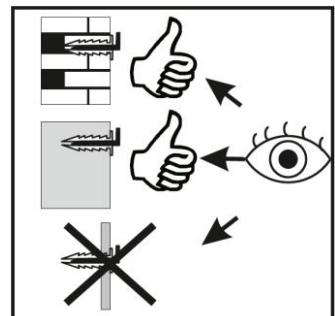
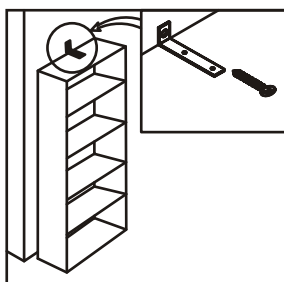
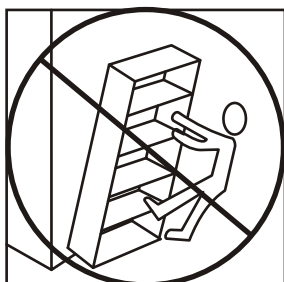
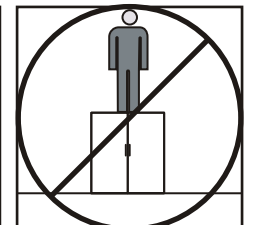
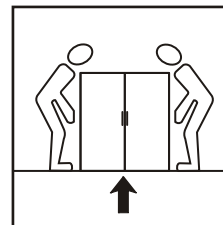
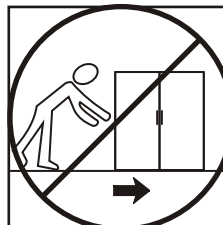
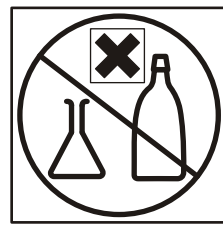
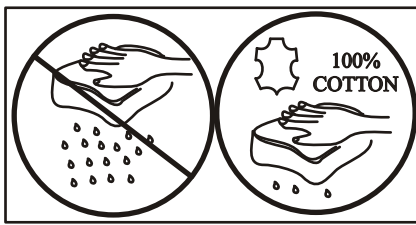
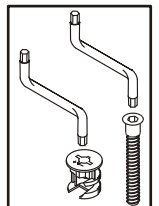
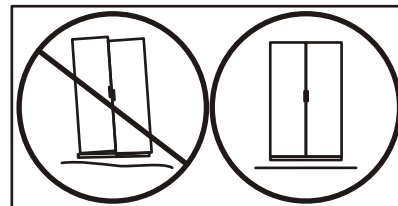
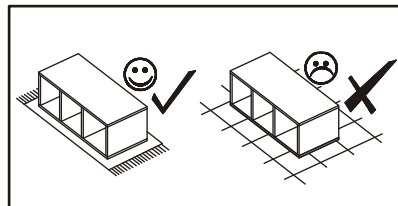
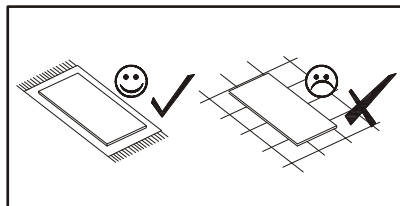
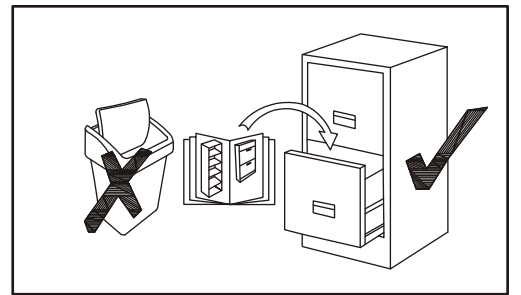
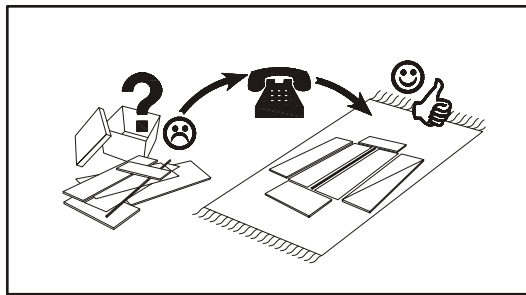
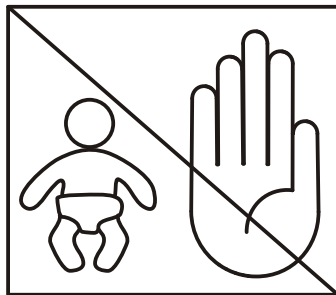
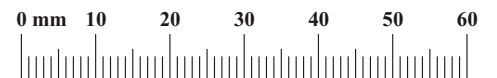

1

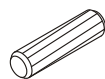
|    |  |
|----|--|
| A1 |  |
| x8 | ø8x36  |

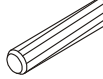
|    |   |
|----|---|
| A3 |  |
| x4 | Ø8x47   |

|     |   |
|-----|---|
| B5  |  |
| x12 | ø15x12  |

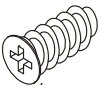
|     |   |
|-----|---|
| D20 |  |
| x6  | ESØ6,3x9,5  |

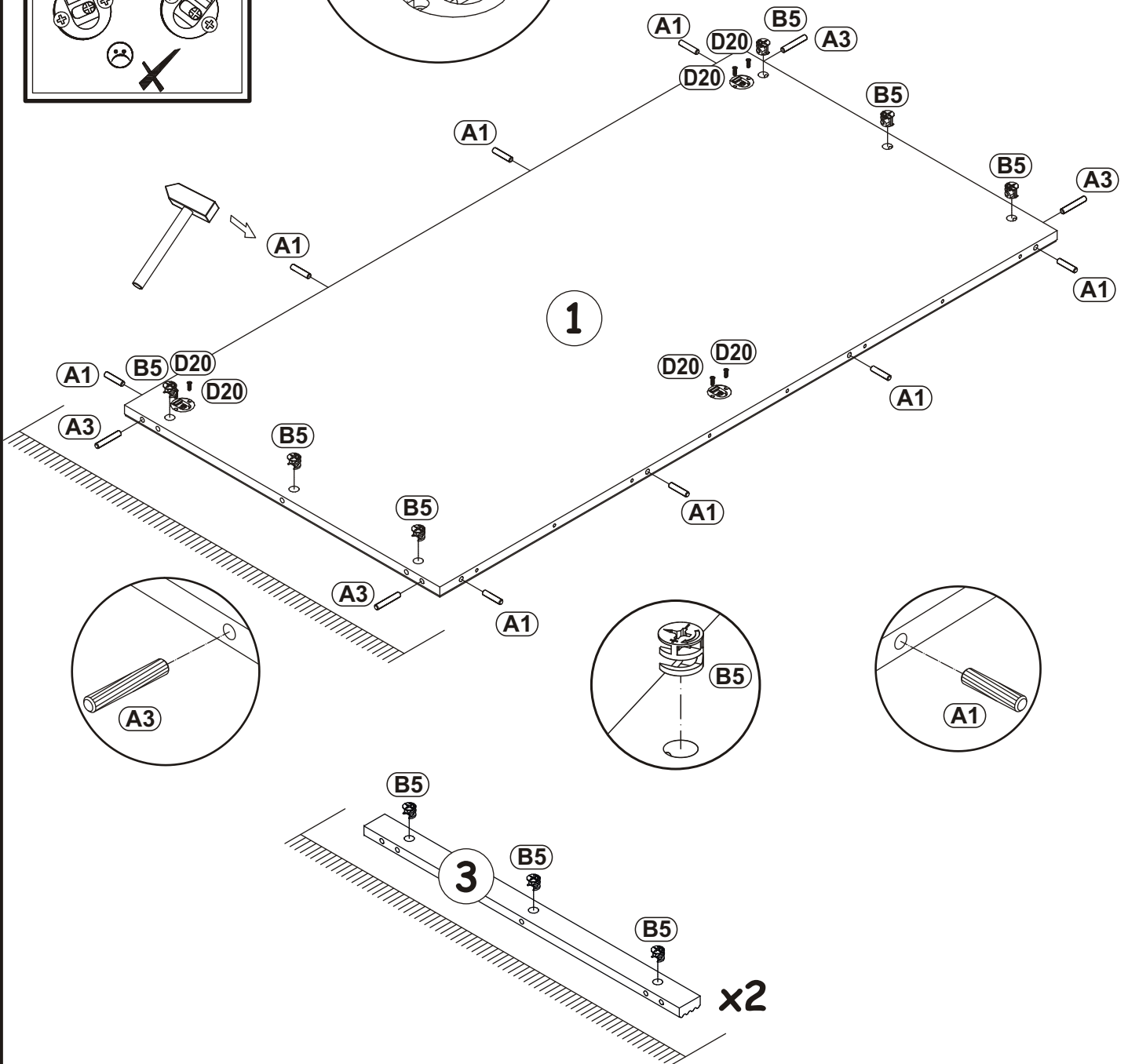
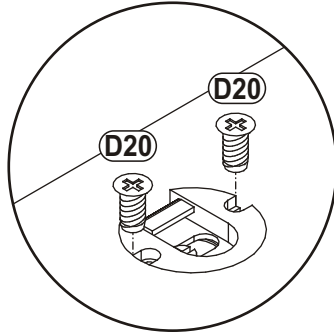
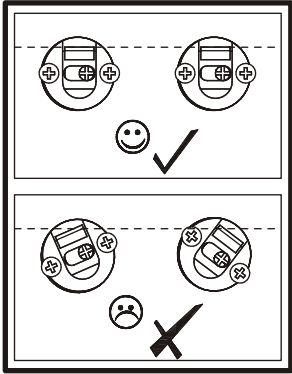

|    |   |     |   |
|----|---|-----|---|
| B9 |  | G5  |  |
| x6 | Ø7x48   | x12 |   |

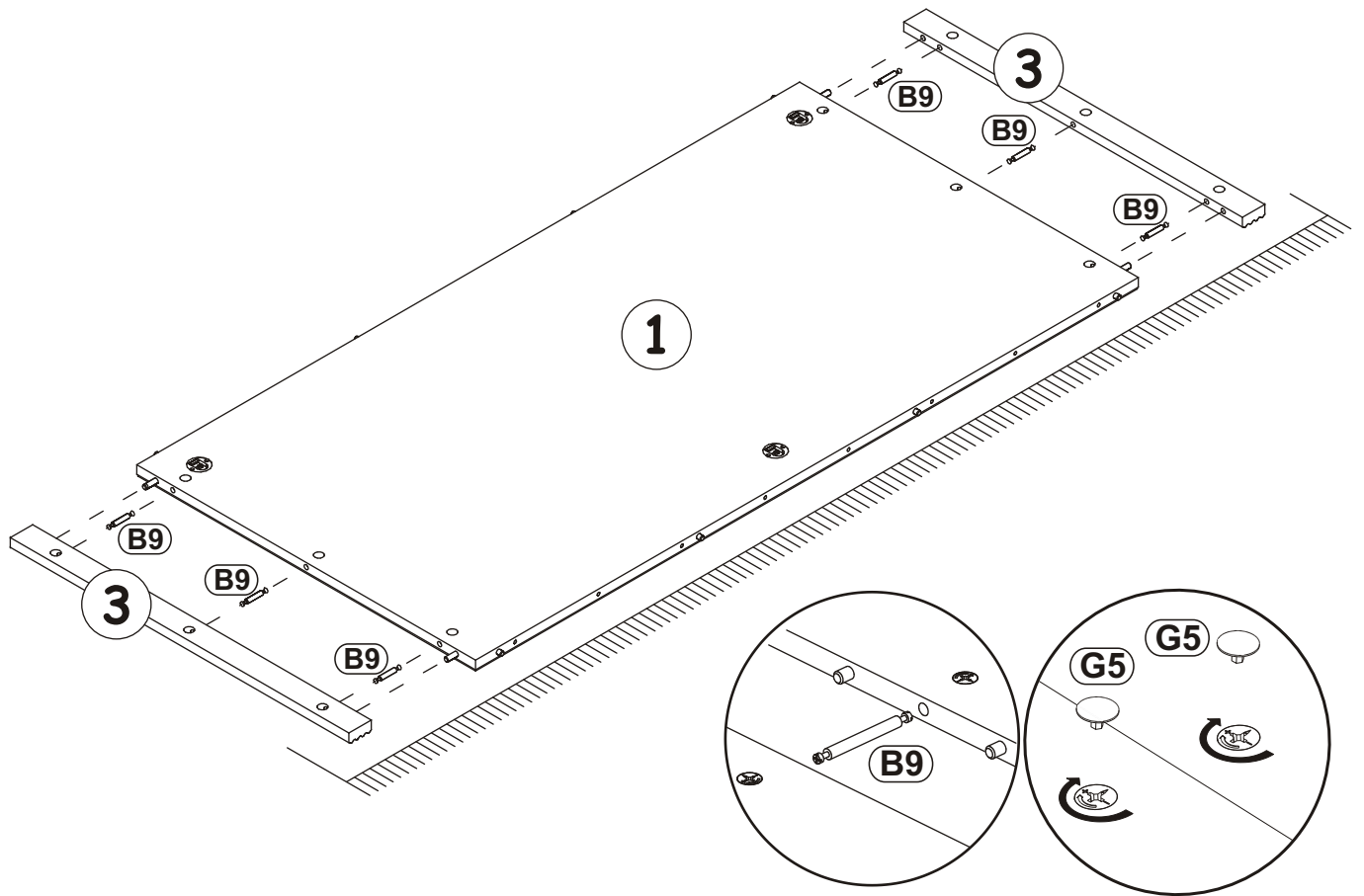

2

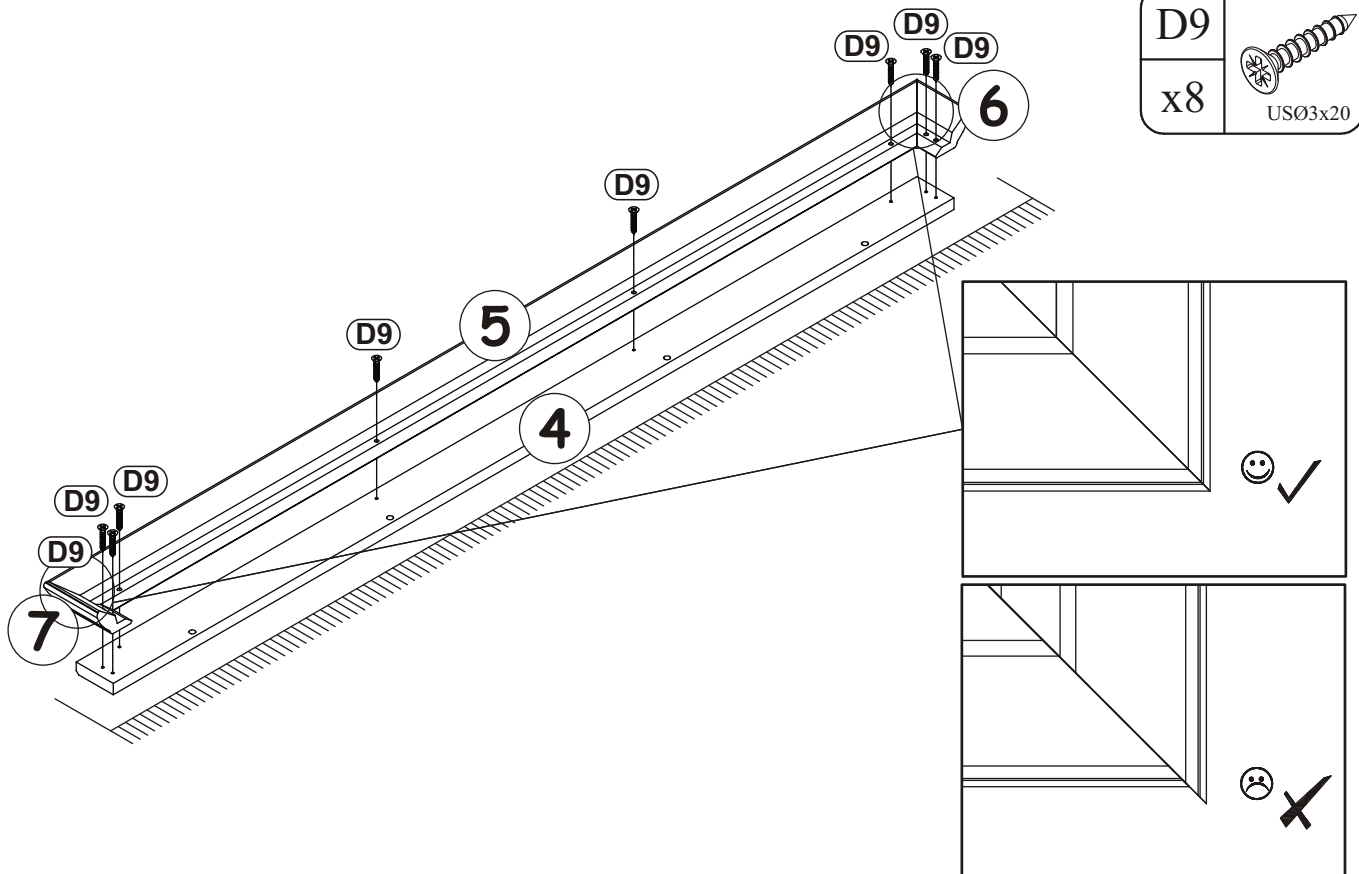

3

|    |   |
|----|---|
| D9 |  |
| x8 | USØ3x20   |



|     |  |     |   |
|-----|--|-----|---|
| B11 | <br>Ø7x50 | G4  |  |
| x12 |  | x12 |   |

4

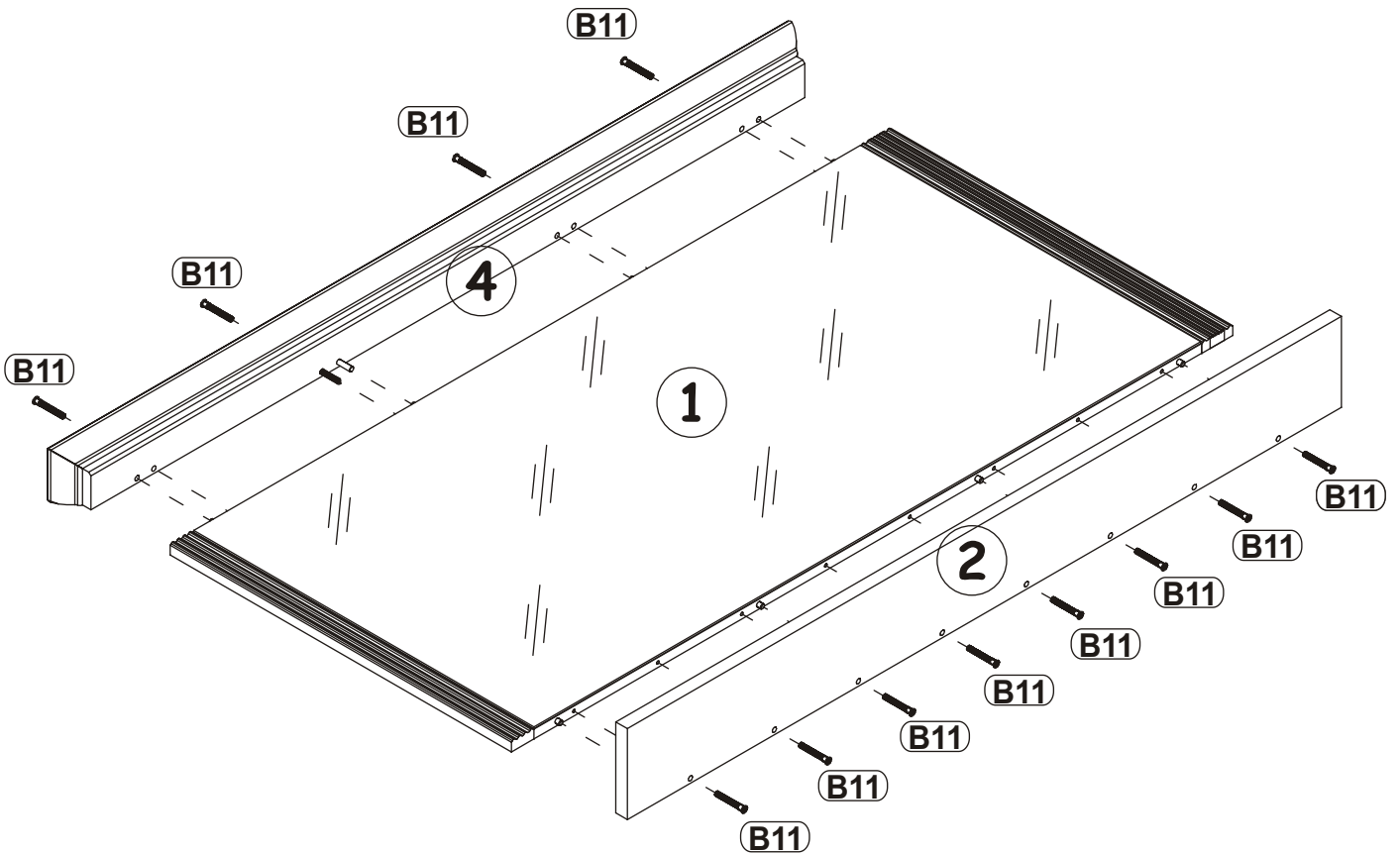
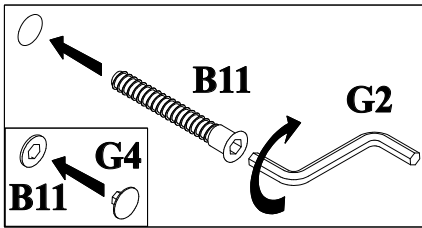

KR2  
x3

5

