

980889

1.

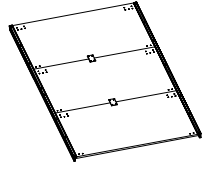

2.

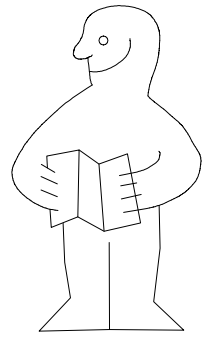
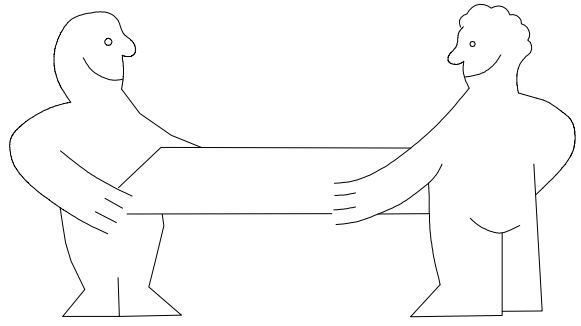
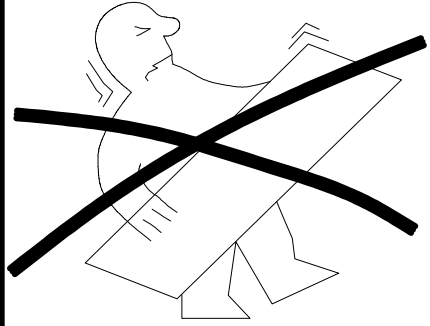
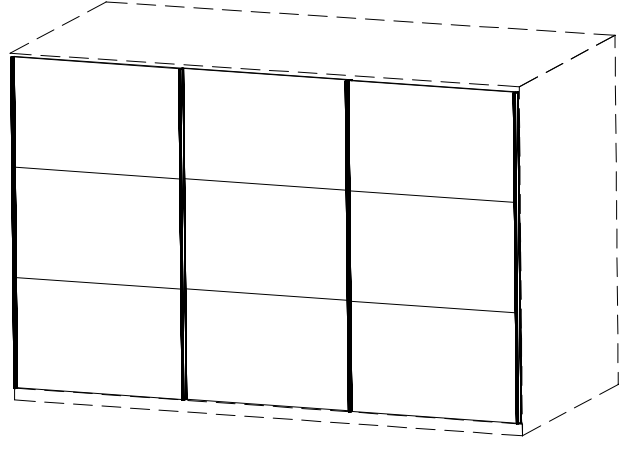
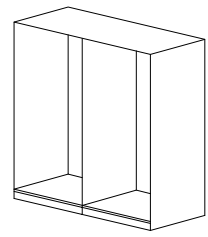
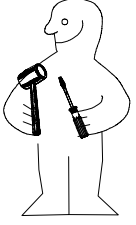

1-2-3-4... ○

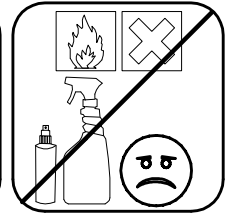
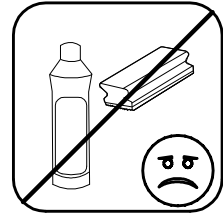
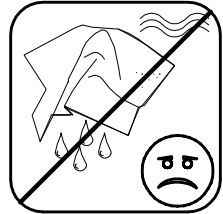
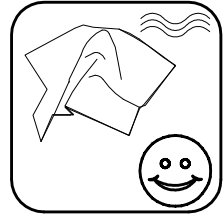
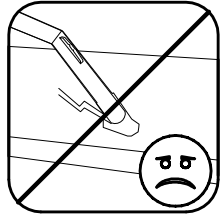
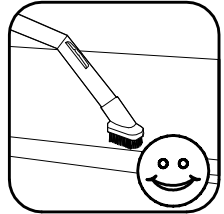
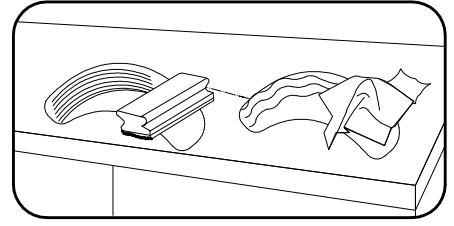
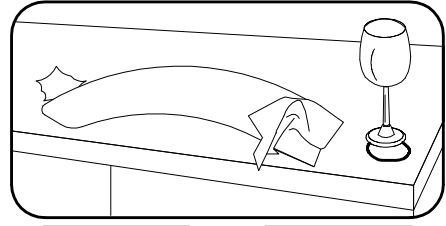
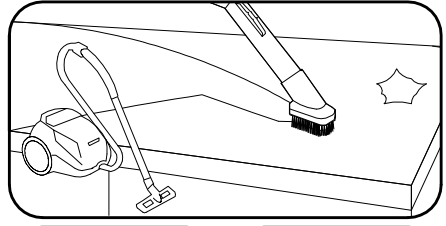
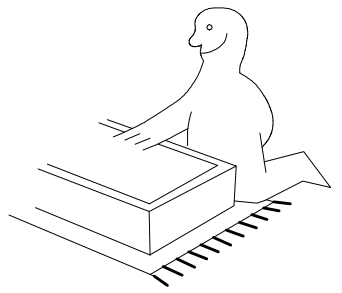
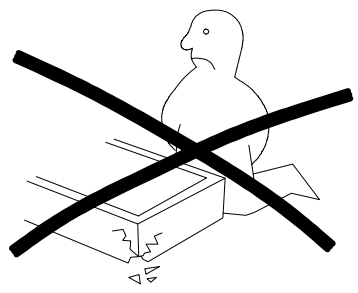
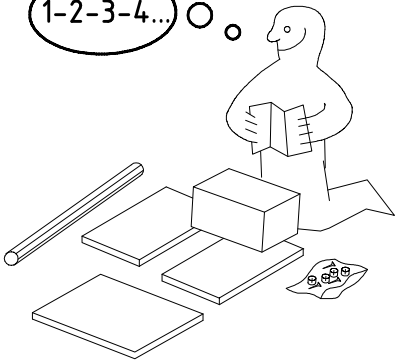

1x
FPN

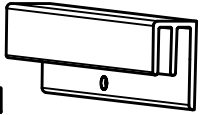

1316/
1760/2204/2648/3092

1x
LP

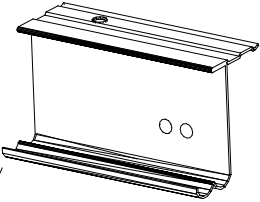

1316/
1760/2204/2648/3092 ST

	SWH1	2x
	SWH2	2x
	SWH3	2x
	SWH 6	2x
	SWH 7	4x

	SWH-D	2x
	SWH-SKL	1x
	SWH-SKR	1x
	SWH-ST	2x
	SWH-MS	2x

	SP13 4 X 13mm	91x
	G24 3,5 x 22 mm	115x
	T2 M6,3 x 10,5 mm	10x
	H5 111 030	34x
	114 183	6x

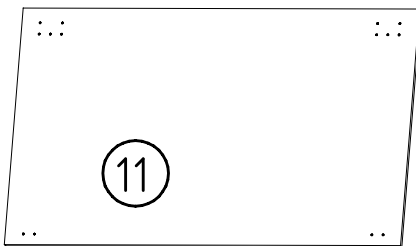
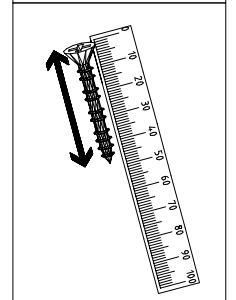
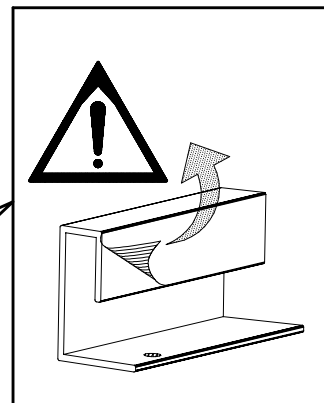
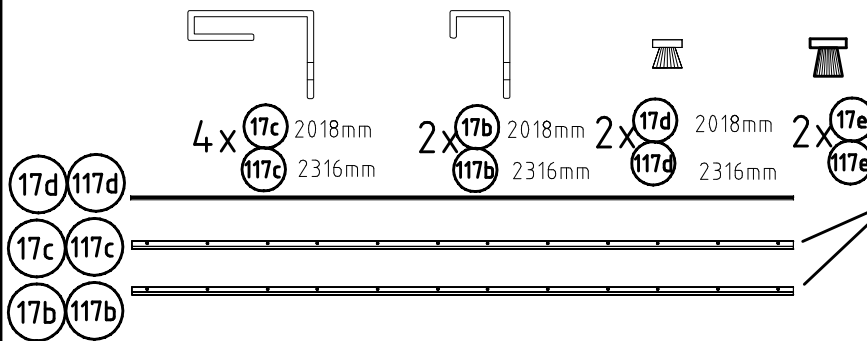
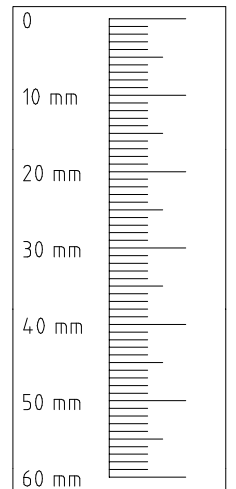
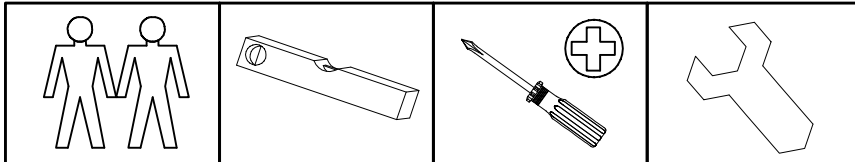
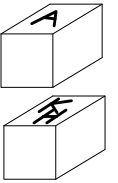

9x 1060 x 673 x 15

9x 1060 x 772 x 15

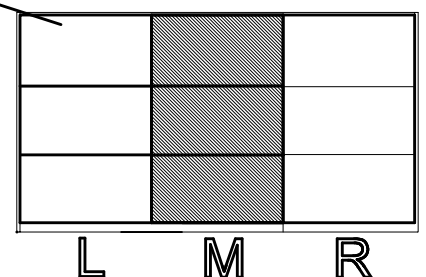
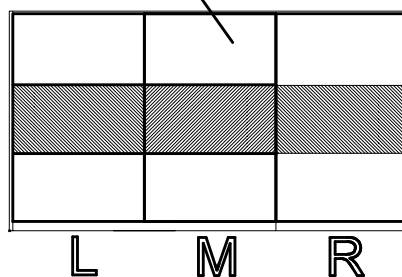
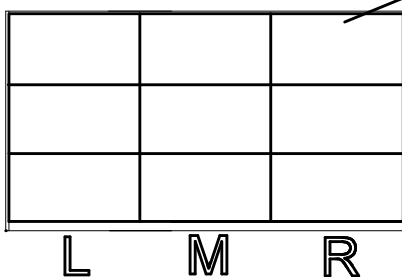
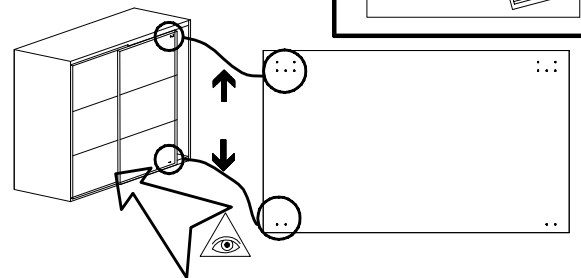

1

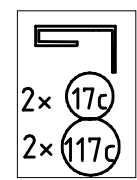
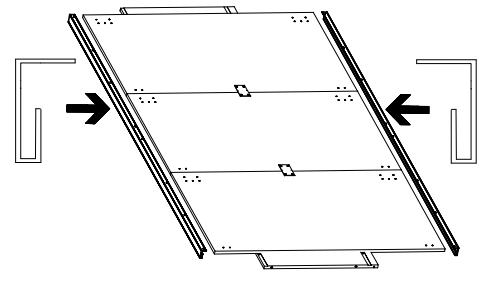
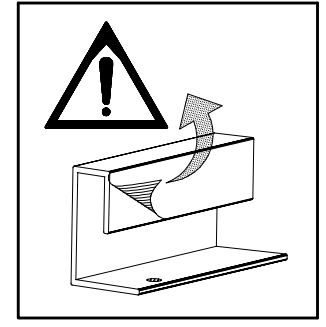
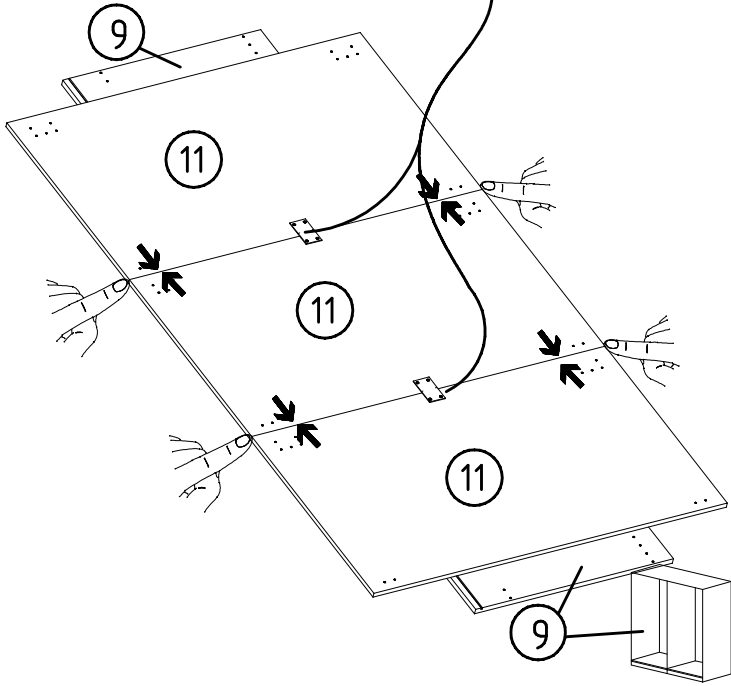
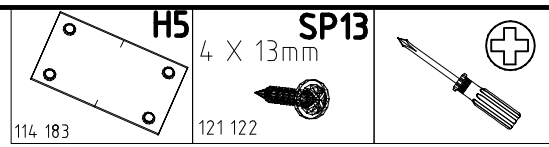
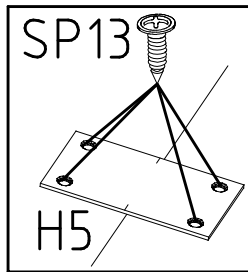
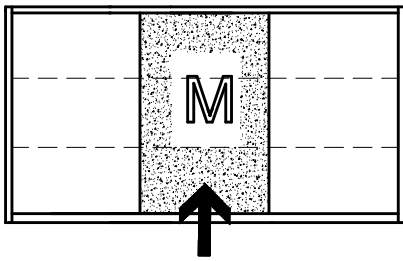

2

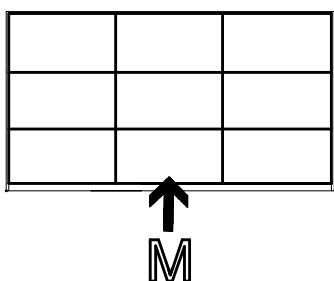
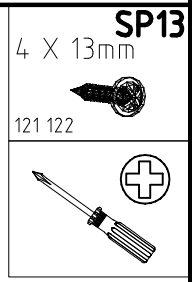
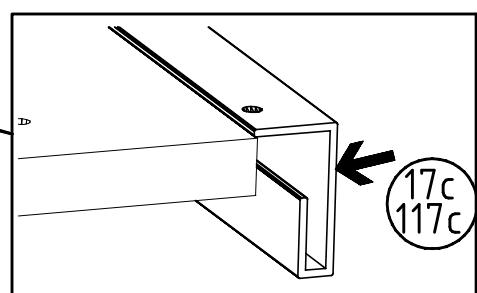
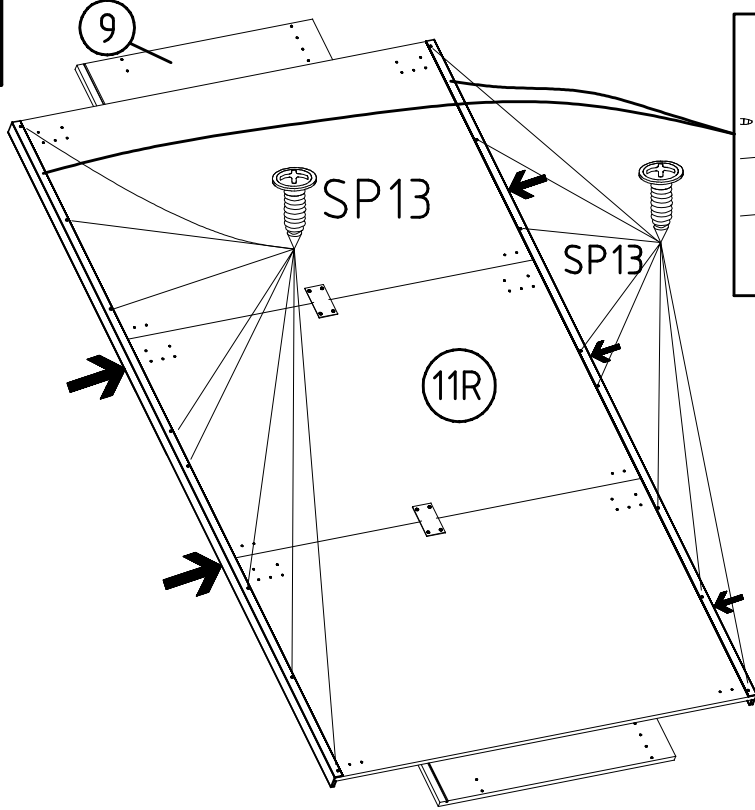

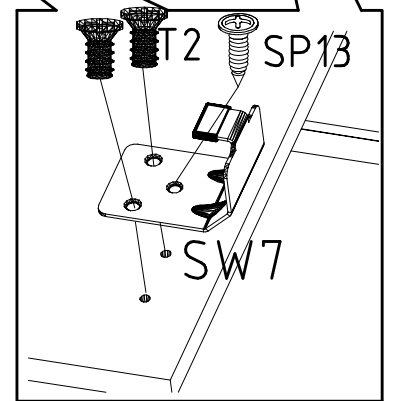
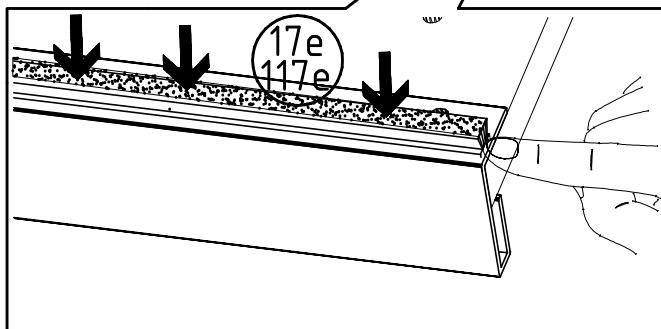
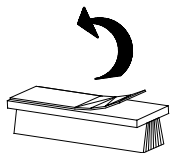
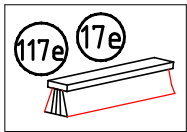
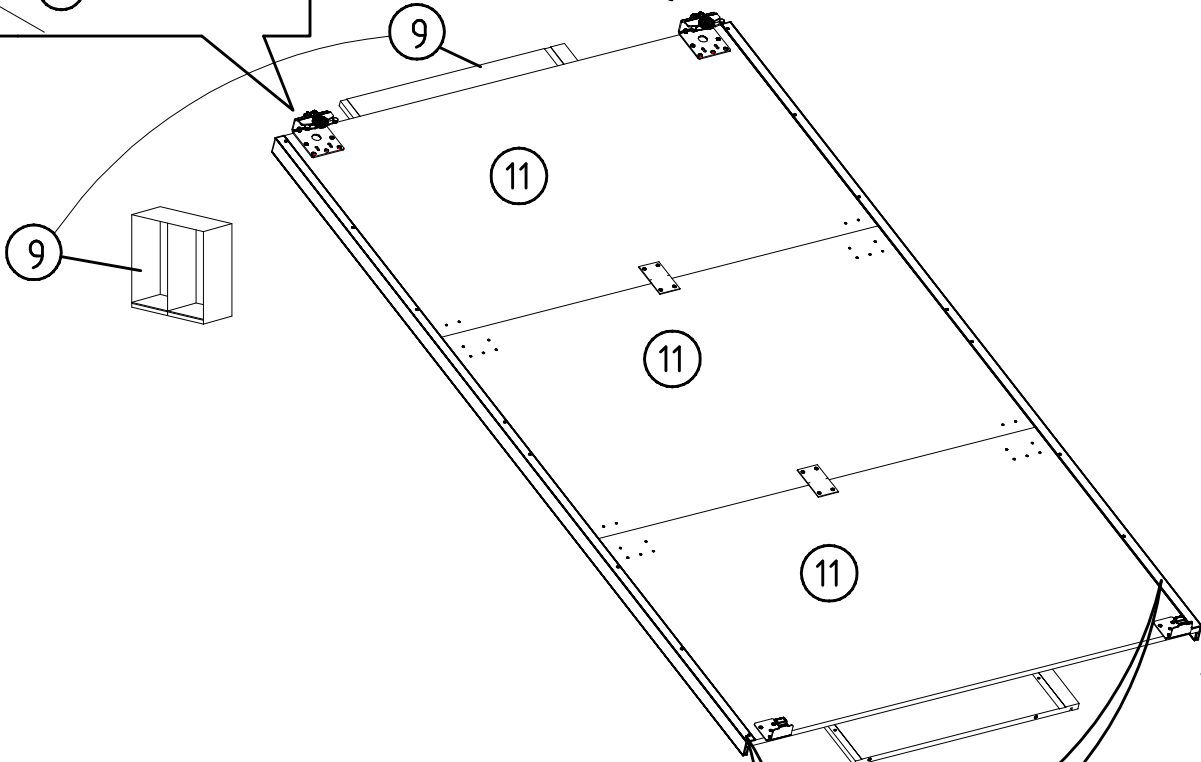
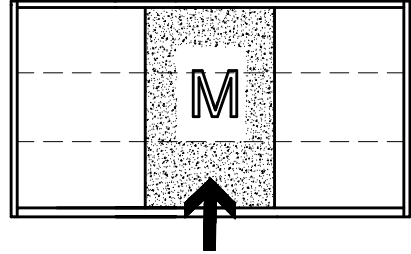
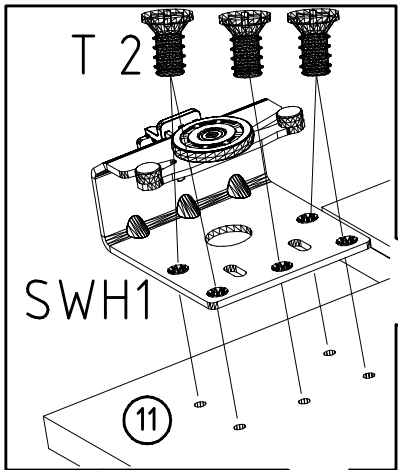
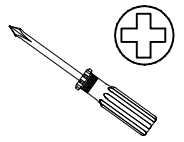
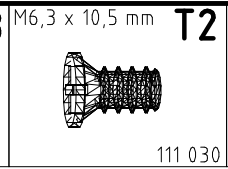
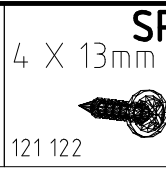
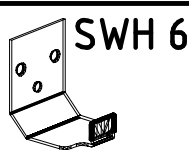
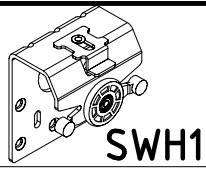

4

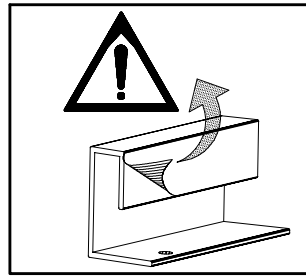
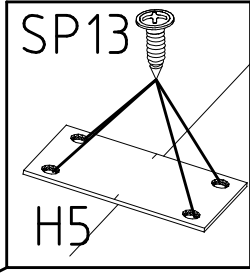
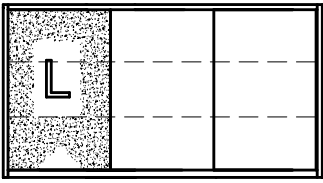

H5 4 X 13mm SP13
114 183 121 122

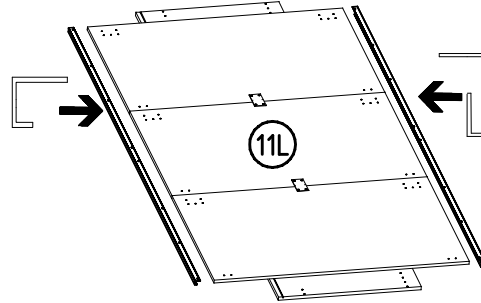
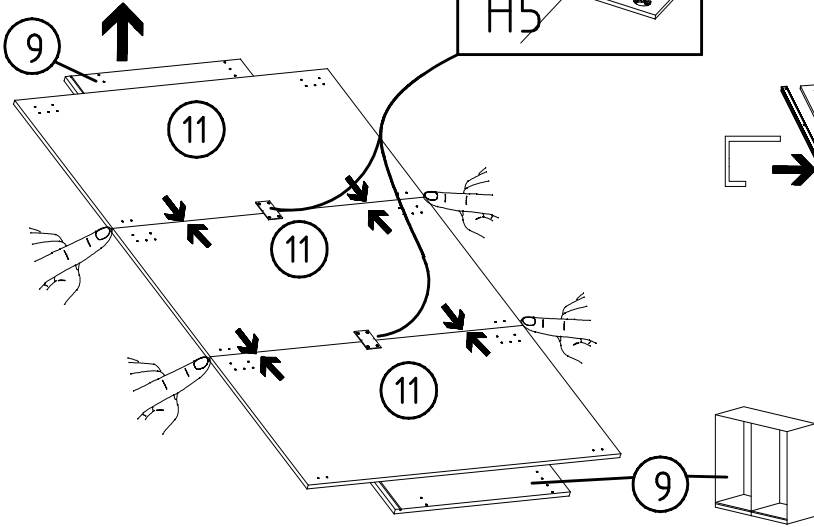
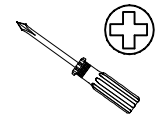

1x (17c) 1x (17b)
1x (117c) 1x (117b)

5

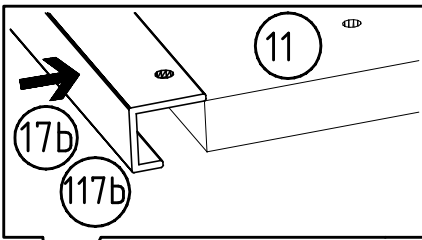

4 X 13mm SP13
121 122

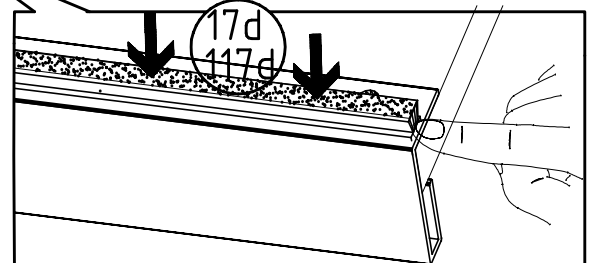
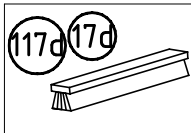
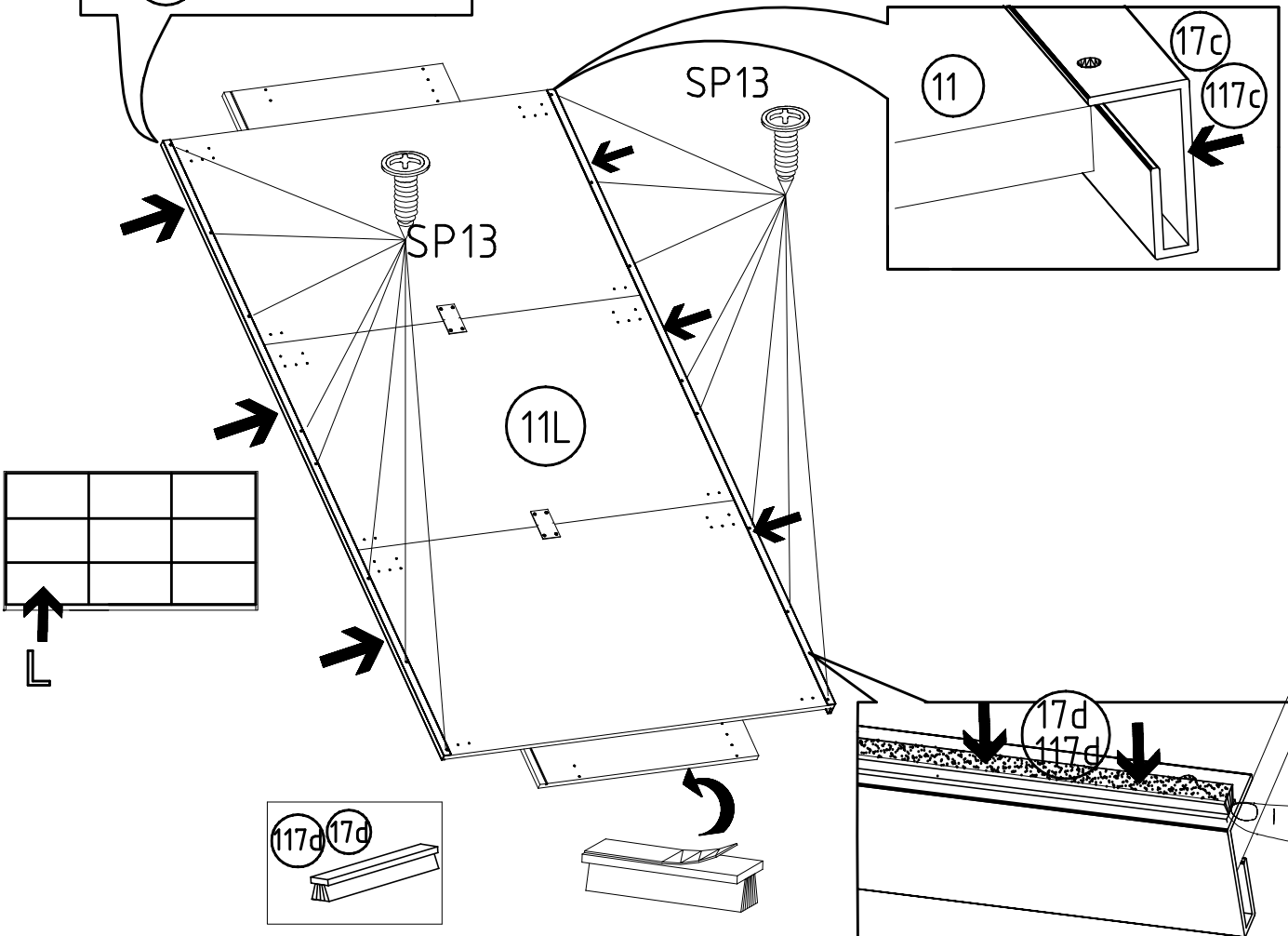
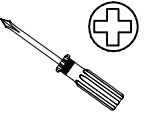

6

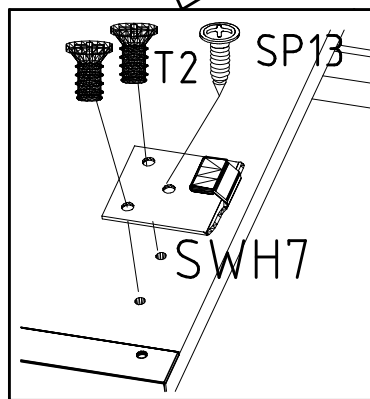
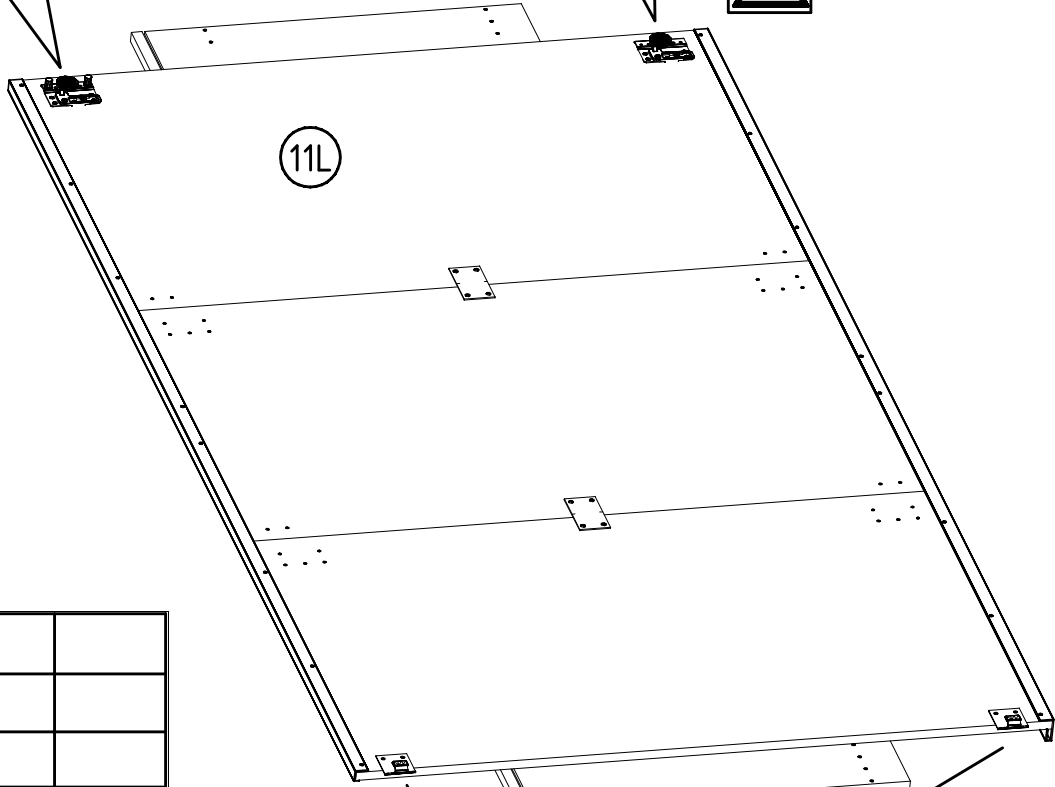
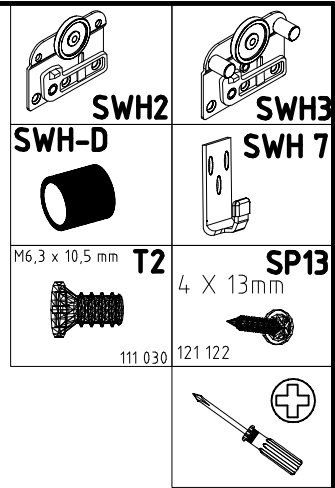
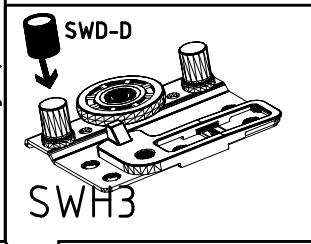
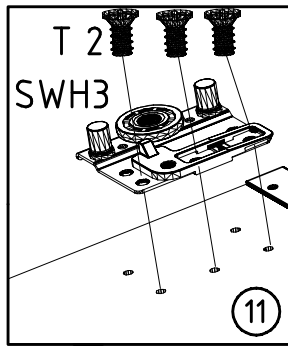
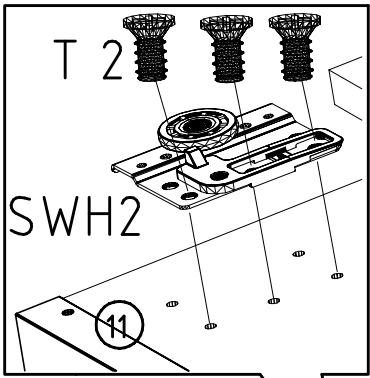

4

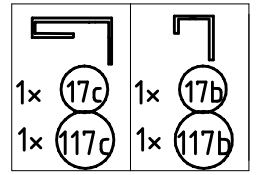
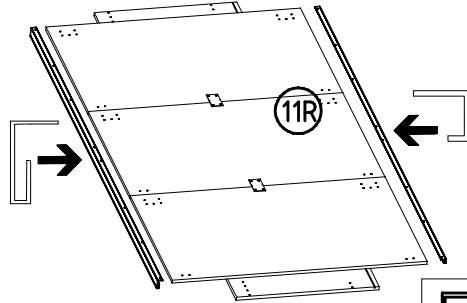
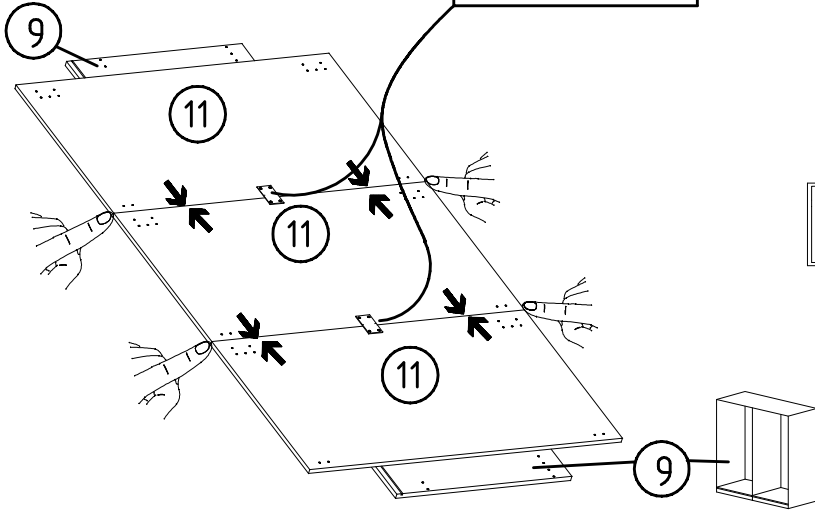
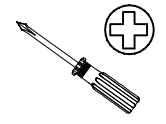
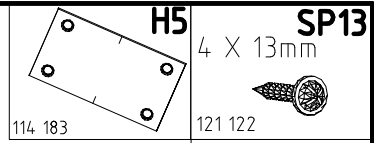
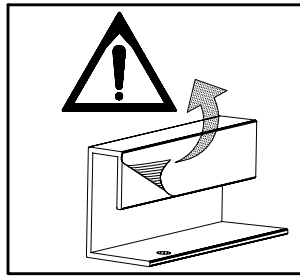
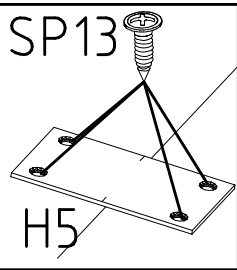
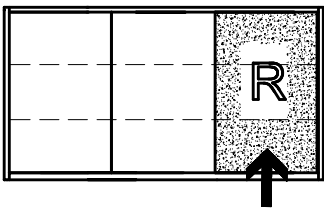

5

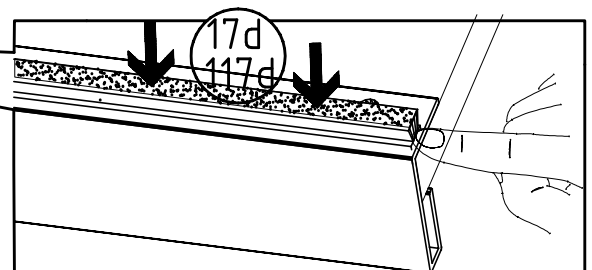
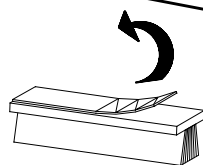
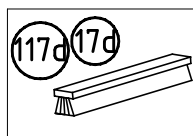
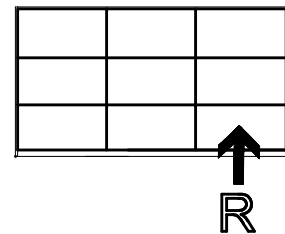
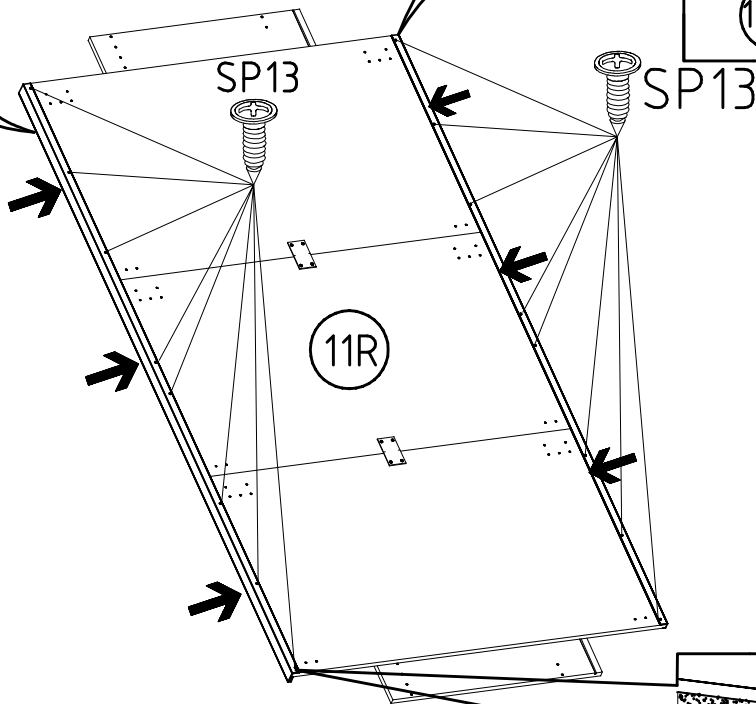
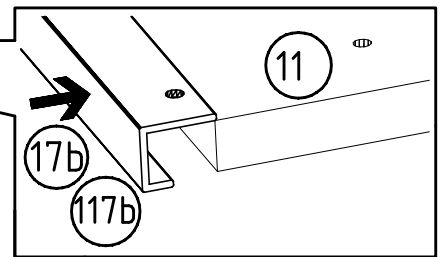
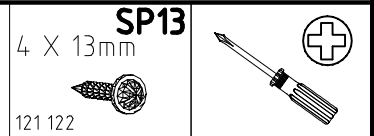
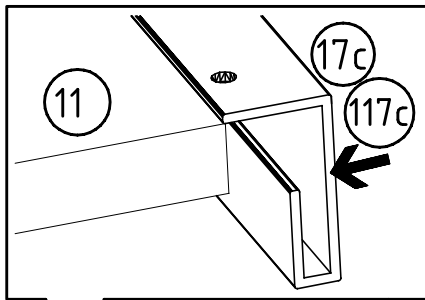

6

