

Paula

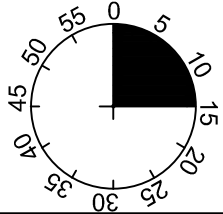

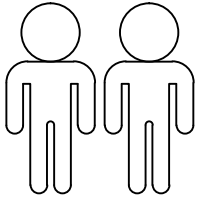

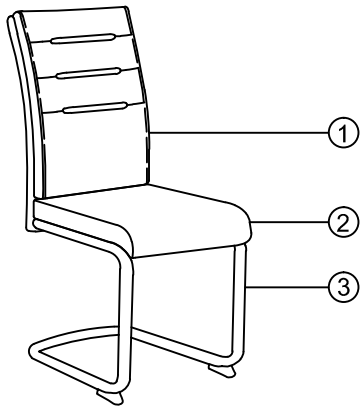



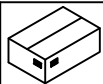
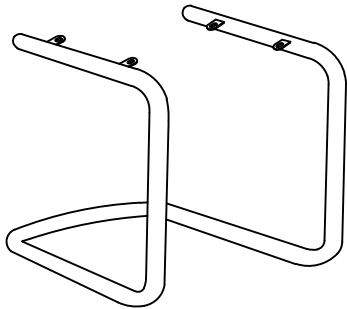
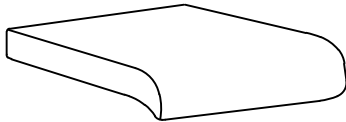
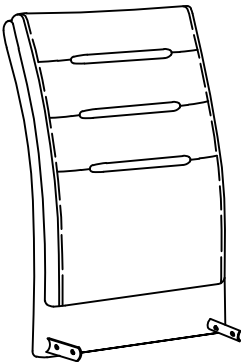

1

2

3

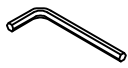

1	1x	1/2
2	1x	2/2
3	1x	2/2

A	M6x20	B	M8x20	C	Ø18xØ8x1.5	D	Ø18xØ6x1.5	E	M8	F	4MM
	4x		4x		4x		4x		4x		1x
G	6MM	H	M4x20	I							
	1x		4x		2x						

I.

1

H M4x20
4x

I 2x

100%

2

B M8x20
4x

C Ø18xØ8x1.5
4x

E M8
4x

G 6MM
1x

75%

3

A M6x20
4x

D Ø18xØ6x1.5
4x

F 4MM
1x

75%

4

F 4MM
1x

G 6MM
1x

100%

