

980037

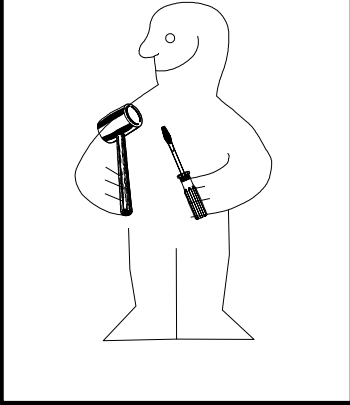

[www.wimex-online.com/montagehilfe/980140.pdf](http://www.wimex-online.com/montagehilfe/980140.pdf)

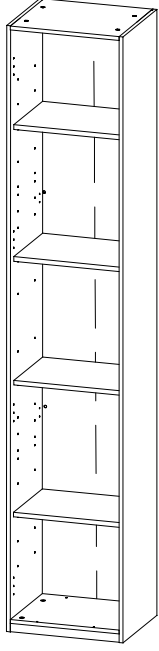

SHS 44

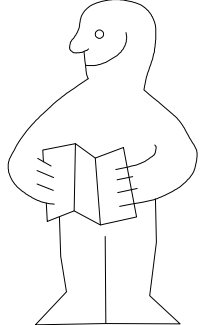
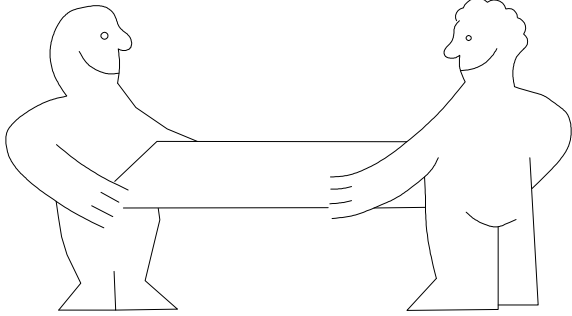
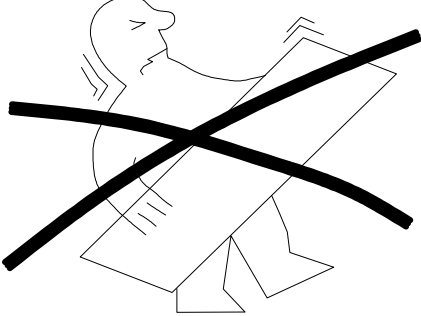

1-2-3-4... ○

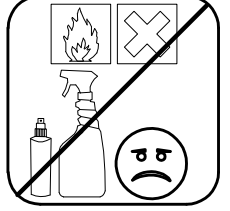
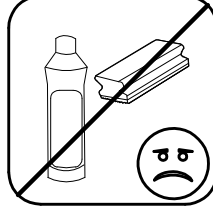
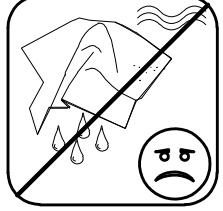
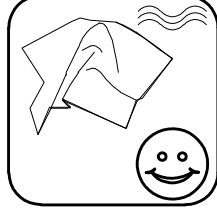
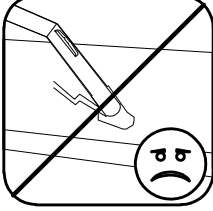
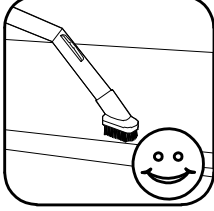
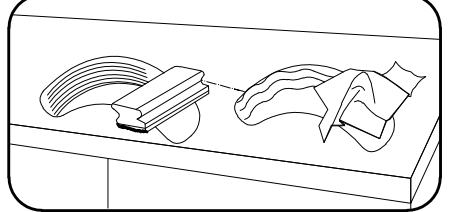
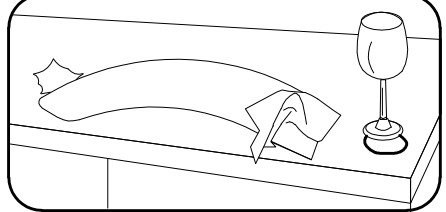
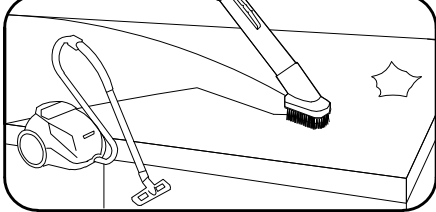
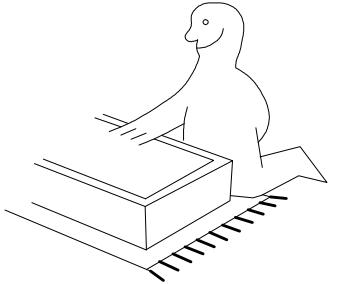
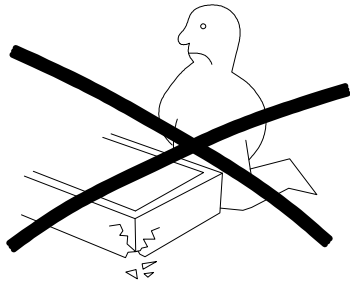
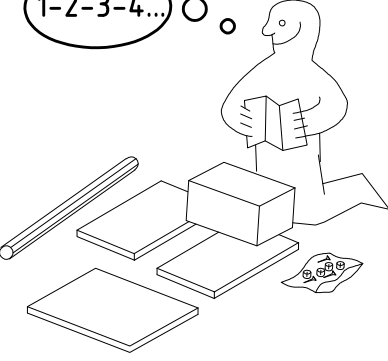





980037



14.04.18 / -

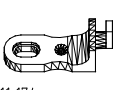

04 18

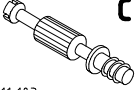
1/6

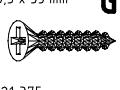
 111 102	<b>A</b> 8x
 111 610	<b>L7</b> 16x
 111 174	<b>J1</b> 4x

M6 x 11 mm  121 181	<b>T6</b> 4x
3,5 x 15 mm  121 370	<b>G1</b> 4x
 111 103	<b>C</b> 8x

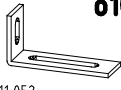
3,5 x 35 mm  121 375	<b>G14</b> 4x
4 x 15mm  121 120	<b>SP15</b> 1x

 111 052	<b>o10</b> 1x
	<b>SBV</b> 4x

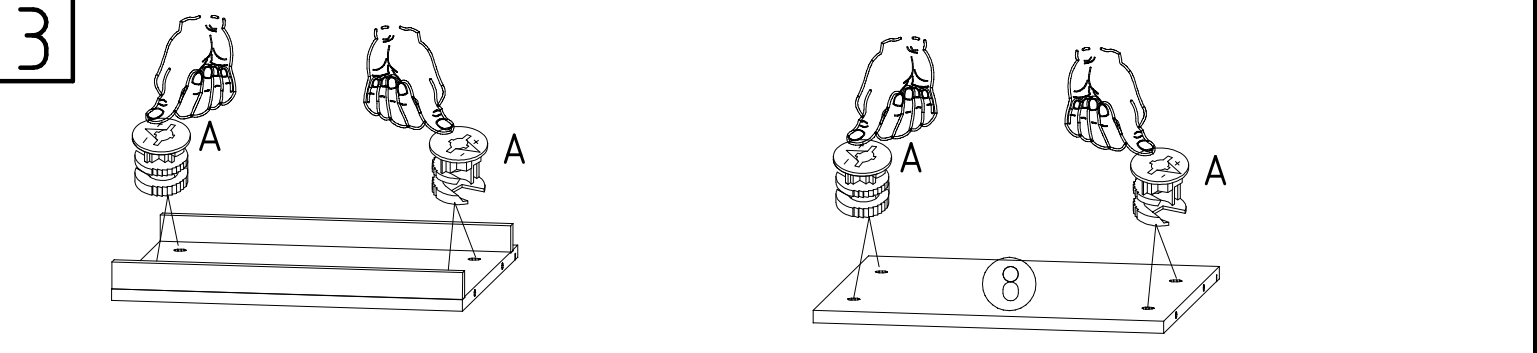
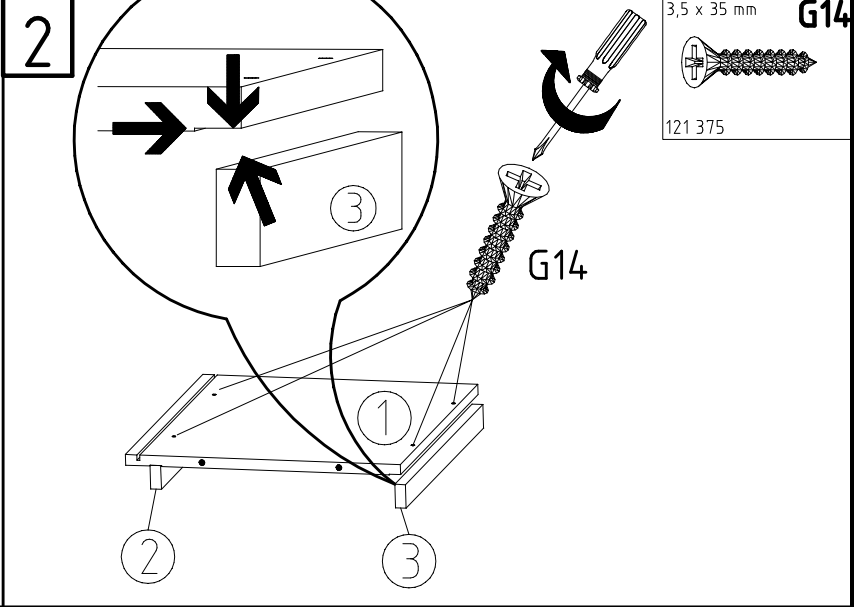
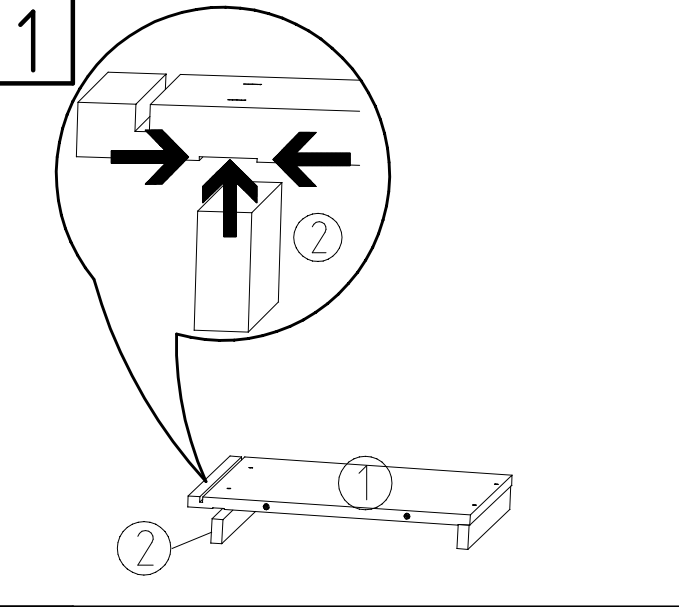
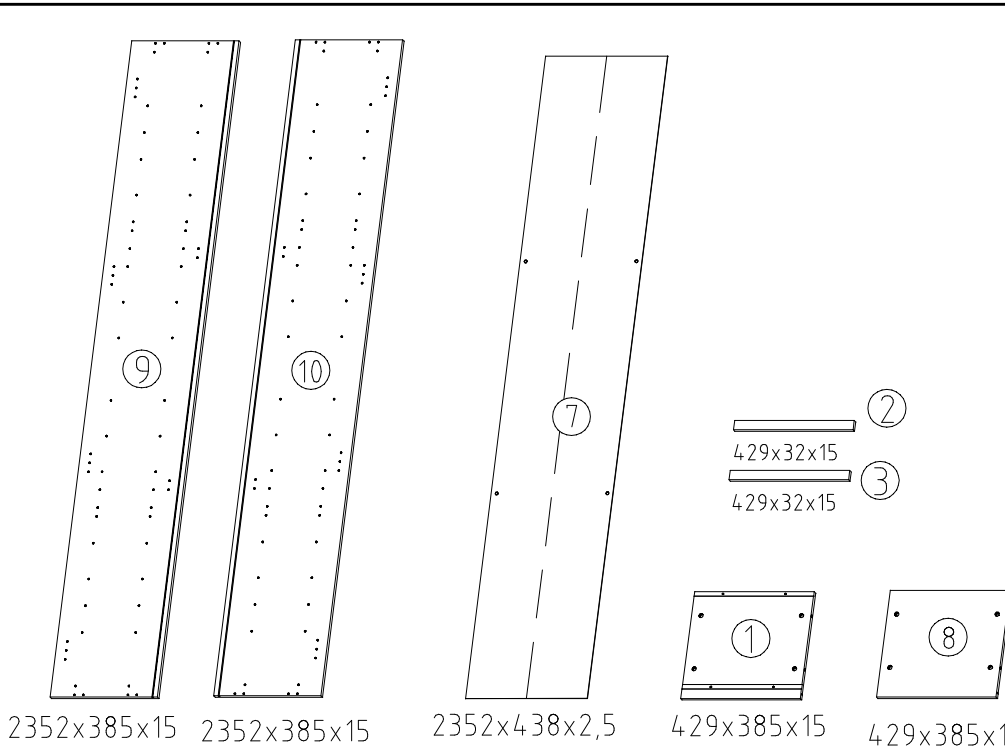
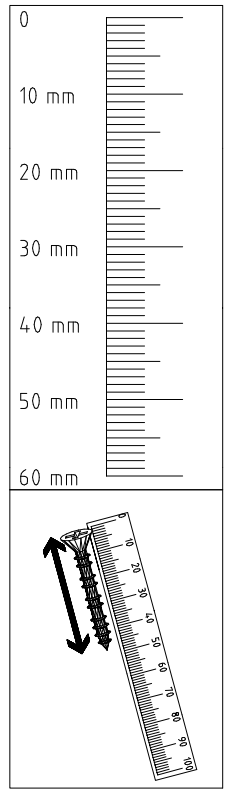

4

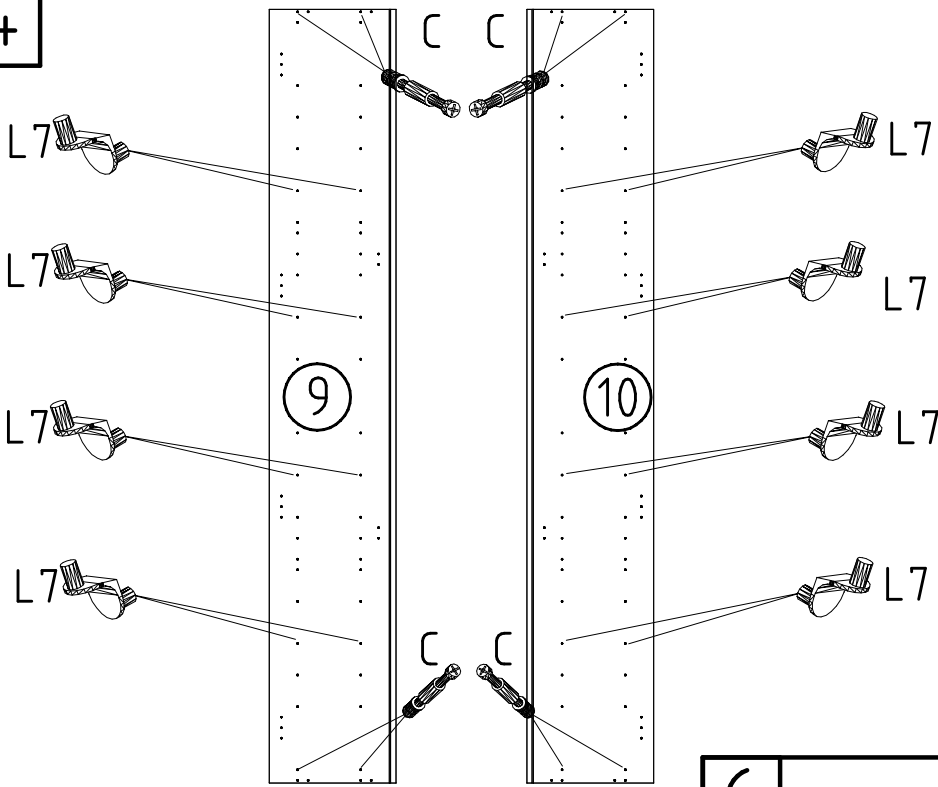

L7

111 610

+

C

111 103

5

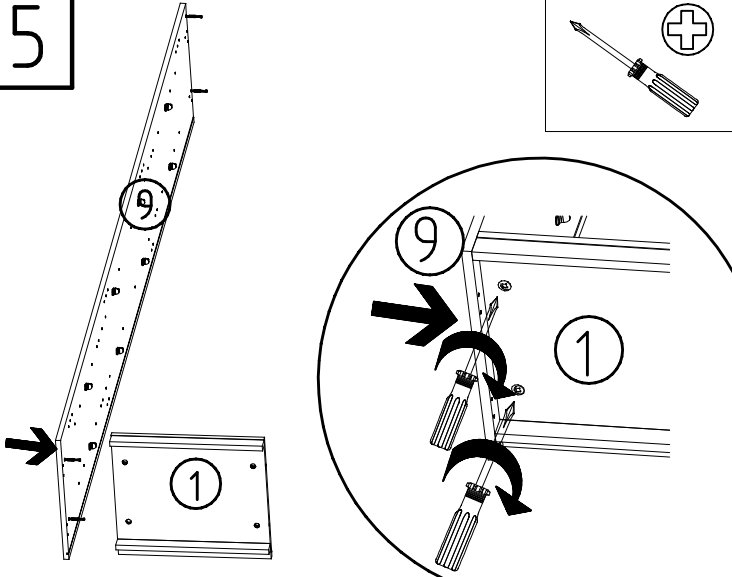

+

6

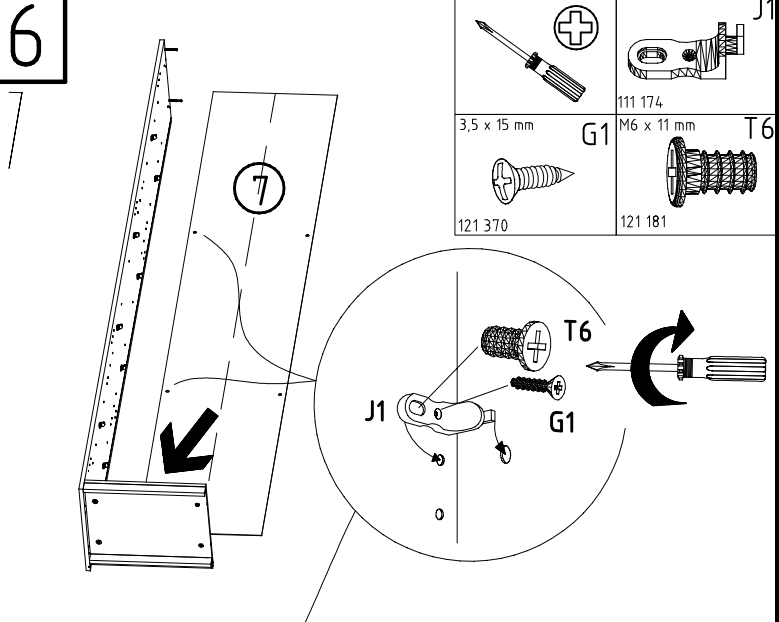

+

J1

111 174

3,5 x 15 mm G1

M6 x 11 mm T6

121 370

121 181

7

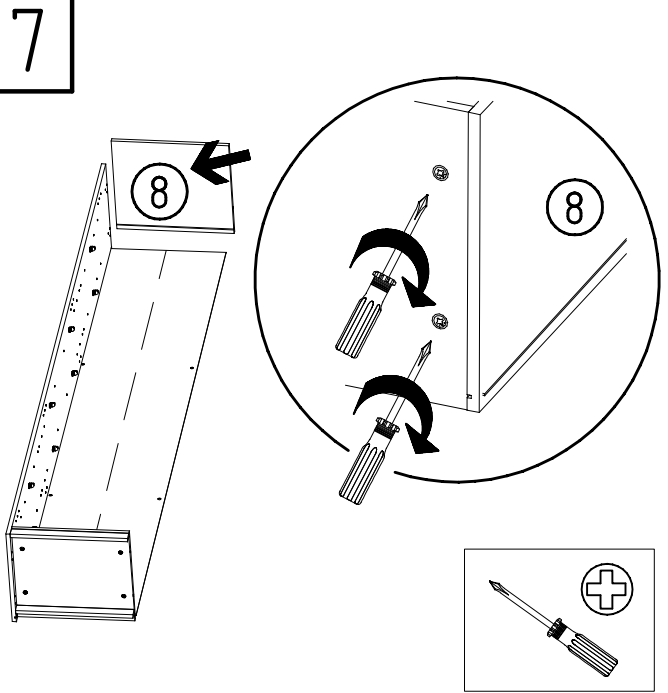

+

8

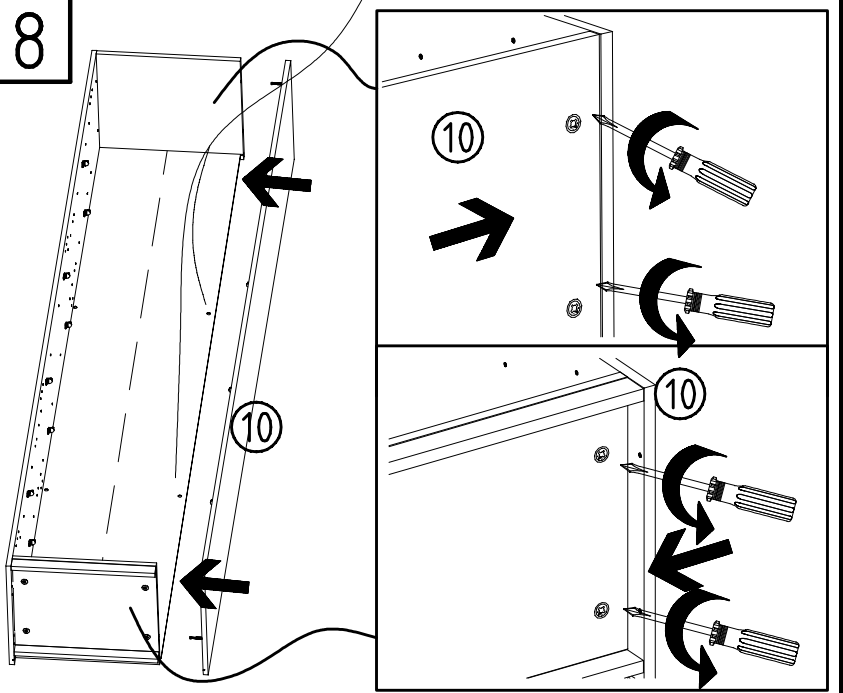

9

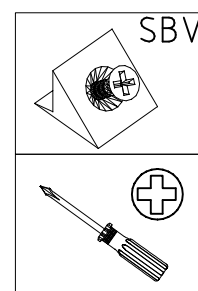
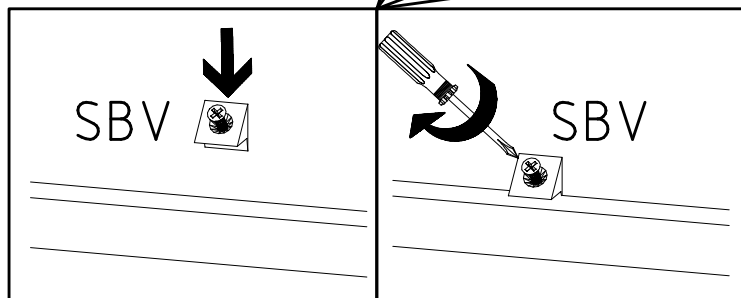
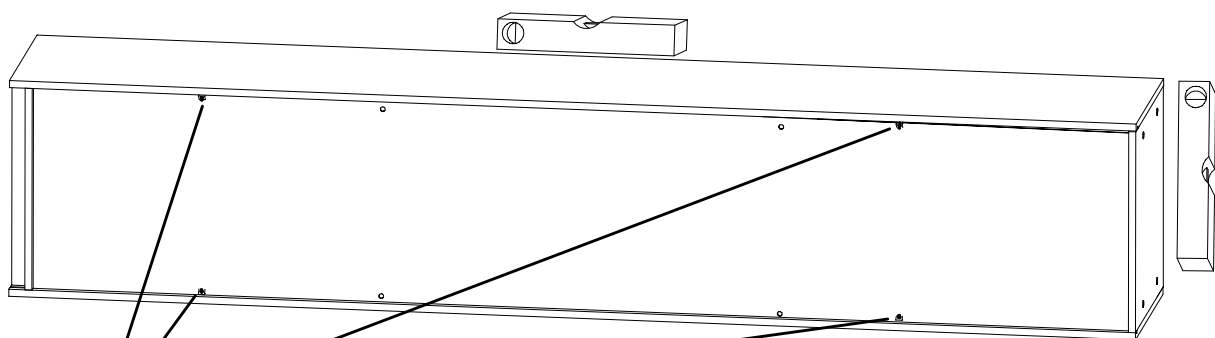

10

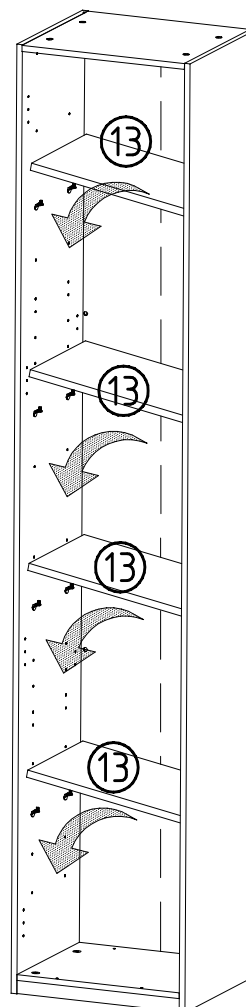
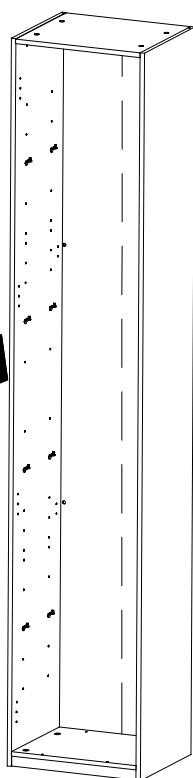
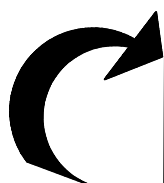
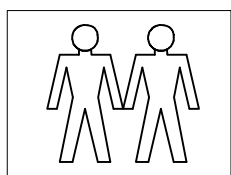

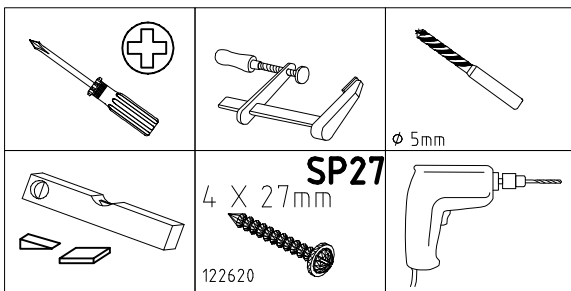
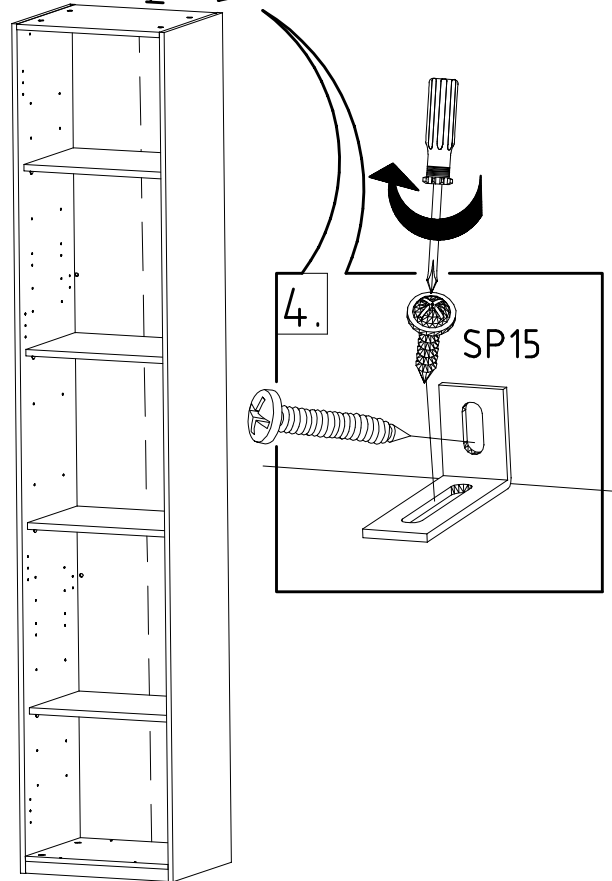
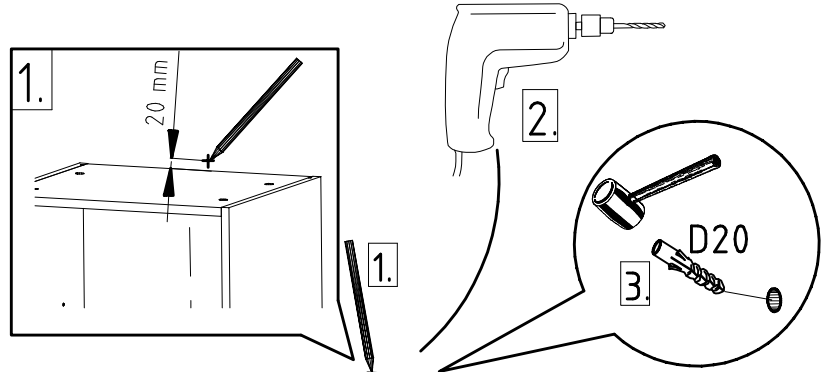
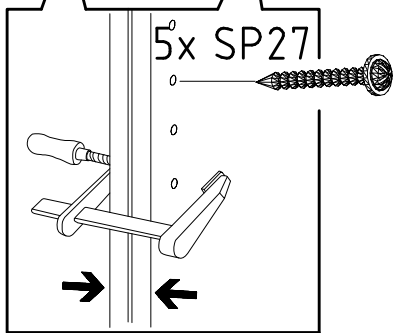
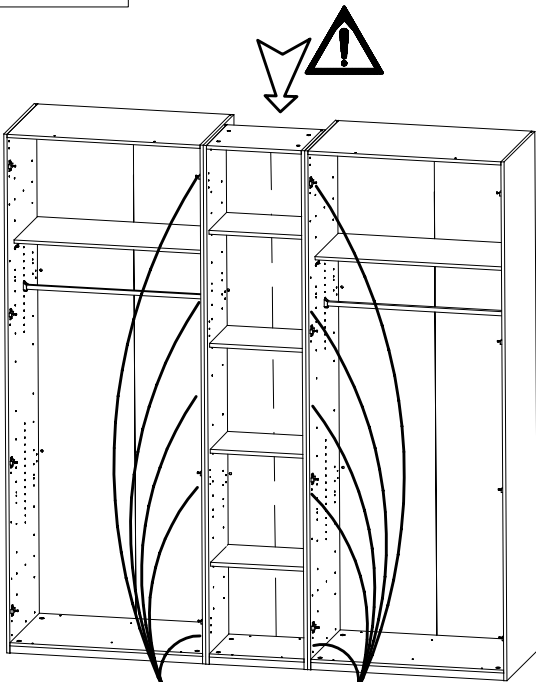
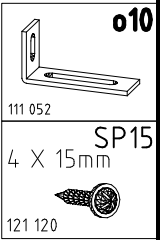
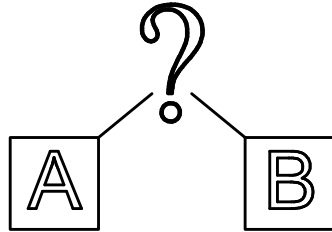
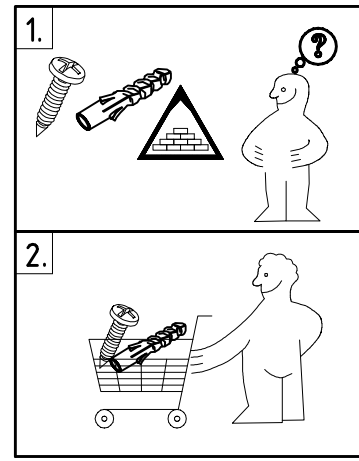

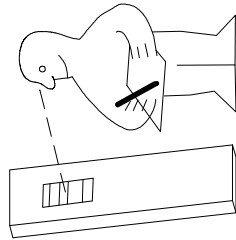
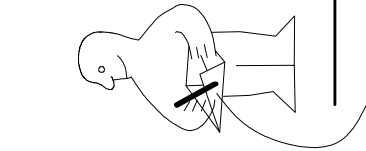
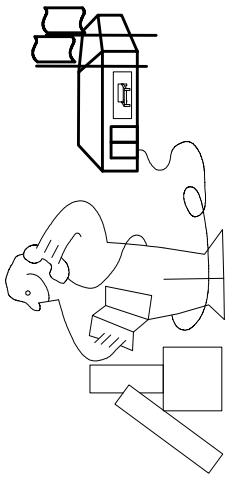
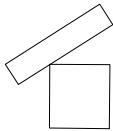
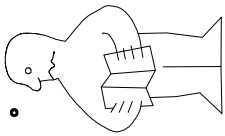

Modell/Model/Modèle

\_\_\_\_\_  
\_\_\_\_\_  
\_\_\_\_\_



\_\_\_\_\_  
\_\_\_\_\_  
\_\_\_\_\_  
\_\_\_\_\_  
\_\_\_\_\_

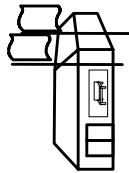

\_\_\_\_\_  
\_\_\_\_\_  
\_\_\_\_\_  
\_\_\_\_\_

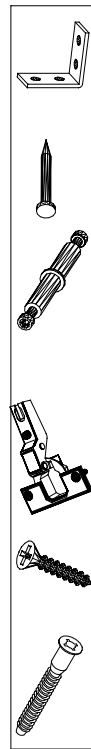

{121 370}	{ G 1 }	{4x}

Änderungen die dem technischen Fortschritt geschuldet sind, behalten wir uns vor !

Bei nicht vorschriftsmäßiger und/ oder nicht fachmännischer Montage wird bei Personen- und/ oder Sachschäden keinerlei Haftung übernommen.

WIMEX Wohnbedarf/ Import Export Handels GmbH/ Postfach 1407/ 49112 Georgsmarienhütte/ Germany  
Tel.:(+49) 05401 8598 72 Fax.:(+49) 05401 8598 33 Mail: service\_H@wimex-online.com

104P-Nr. / 104P-No.    150X-Nr. / 150X-No.    Auftrag/Order-No. / No. de Commande

**23203**    **30110XY**    104

Kunde    MAX MUSTERMANN  
Customer  
Client

Kommission / your order reference / votre reference

**3377 MINDEN**

---

Dekor / Decor    Decor / Modell / Modele

**F99**    **SAMPLE**

F99842 SCHWEBETUERENSCHRANK 250 CM H 216CM  
PLANKENEICHE NB + RAH STEEL  
PLANKENEICHE NACHBILDUNG

202320301107241476000001

Paket / Package / Paquet

**414760**

SOCKEL

Paket 1 von 8    Colli Kommission 10

HSP-SMT BOD 50 TEXT/TEX SOCKEL 32 FRESH TV / LF  
SO-BOD TEXT RASTEX/ ZNBOD D18MM TX KLSTA 104

Montage - Anleitung    Laenge ..... 520,0    OBEREN  
KS-64    Breite ..... 568,0    OBEREN

**SOCKEL32 KLEB**

En cas de dommage, veuillez retourner le carton avec le produit. / En cas de dommage, veuillez retourner le carton avec le produit.

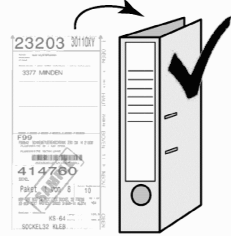

OBEREN 5 30/19 HAUT 23.08.19 OBEREN 1 1. JABOVE OBEREN



**WIMEX Wohnbedarf**  
Import Export Handelsges mbH & Co. KG  
Werner-von-Siemens-Str. 35  
D-49124 Georgsmarienhütte - Germany

**SAMPLE**    **23.08.19**  
Modellname    Produktionsdatum  
Model    Date of manufacture

