

# P185 / P208

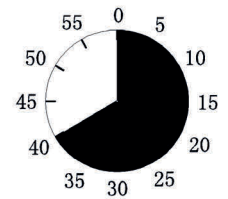

1

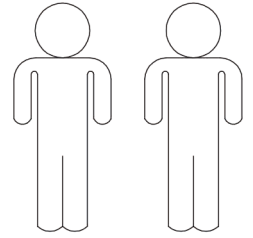
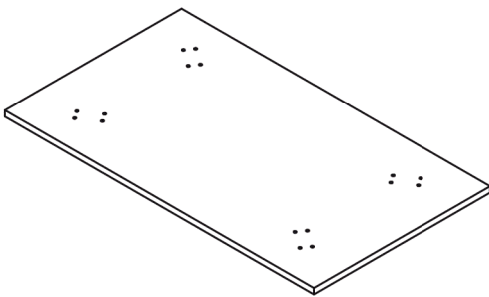

2.1

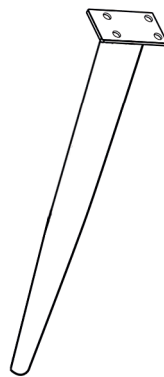

2.2

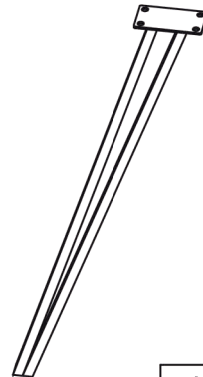

1	1x	1/2
2	4x	2/2

<b>A</b>	M8*12  16X	<b>B</b>	M8*16  16X	<b>C</b>	Ø18*Ø8*1.5  16X	<b>D</b>	Ø25  4X	<b>E</b>	5mm  1X
<b>F</b>	8mm  1X								

1.  
1.

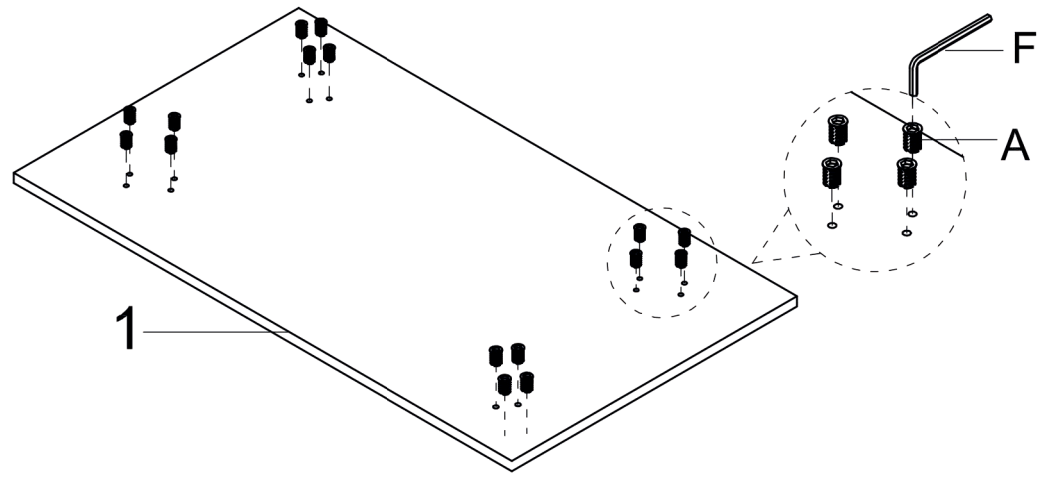

- A M8\*12  
16X
- F 8mm  
1X
- 

2.1

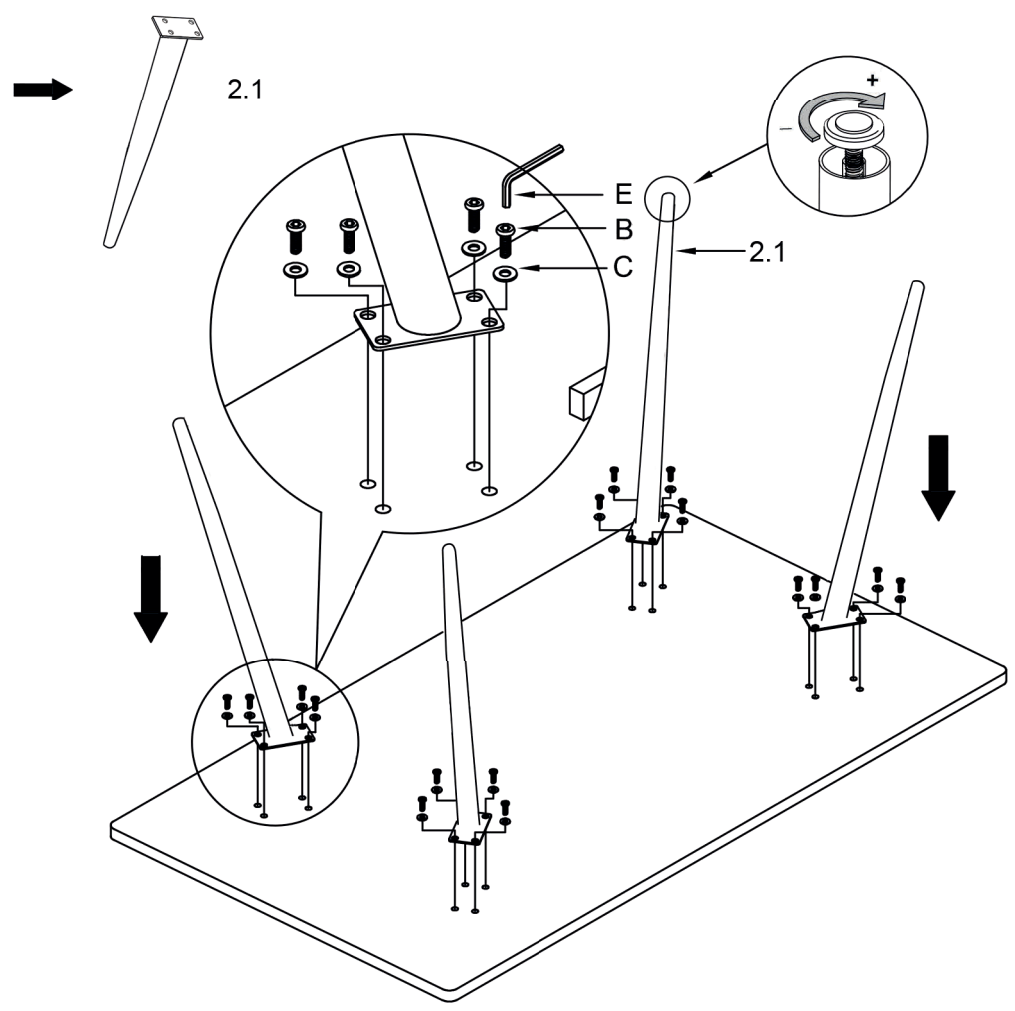

- B M8\*16  
16X
- C Ø18\*Ø8\*1.5  
16X
- E 5mm  
1X
-

1.  
2.2

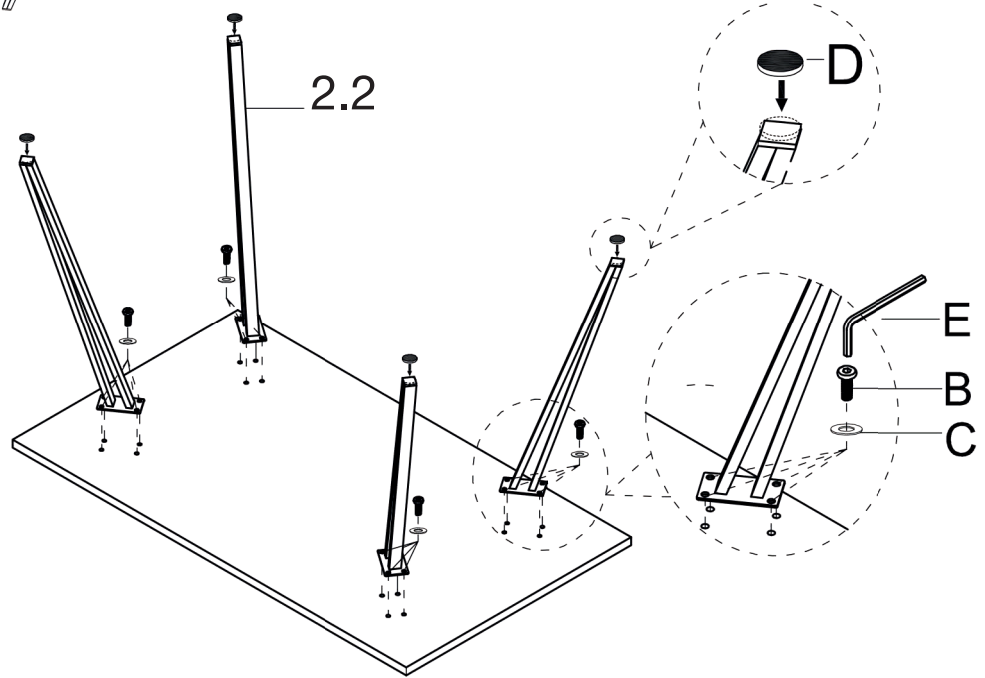
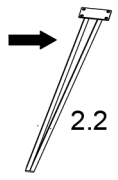

B	M8*16 16X
C	Ø18*Ø8*1.5 16X
D	Ø25 4X
E	5mm 1X

3.

