

980428

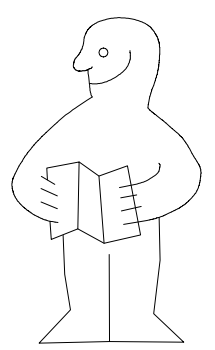

1-2-3-4... ○

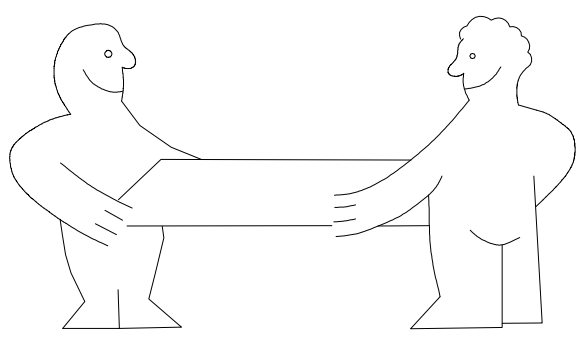
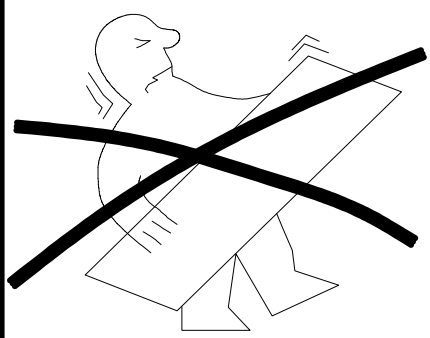
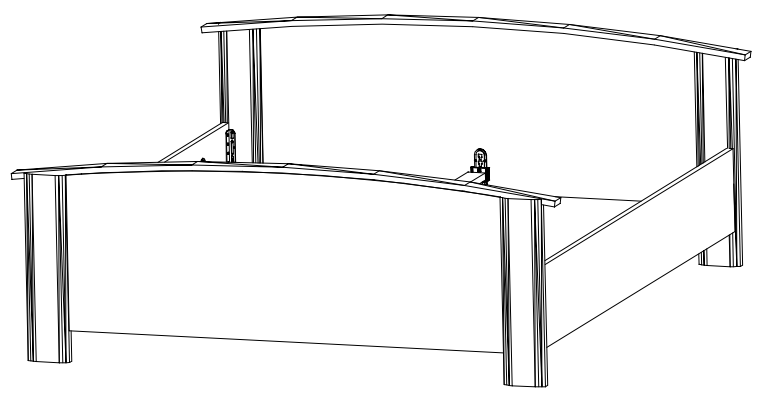
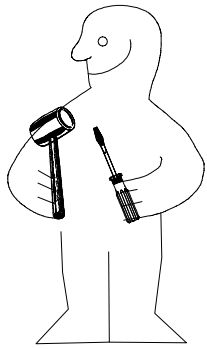
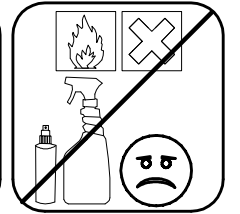
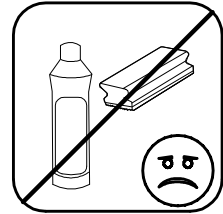
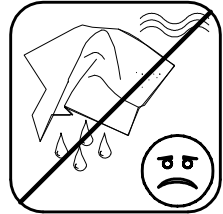
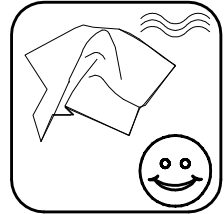
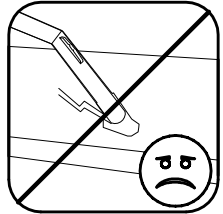
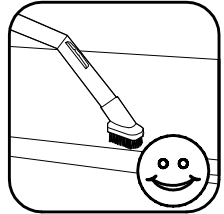
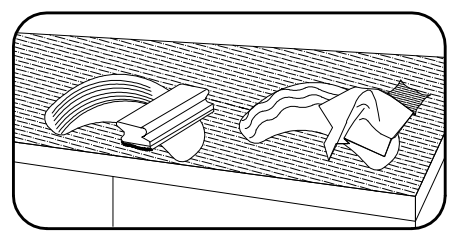
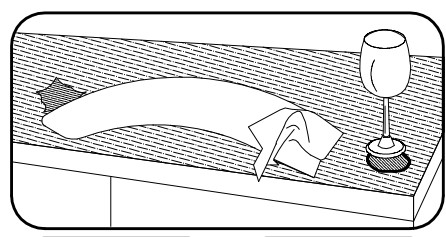
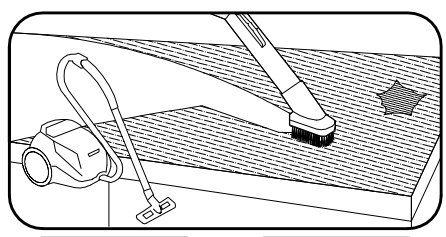
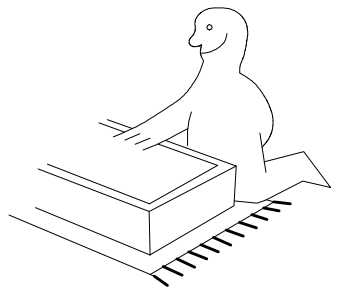
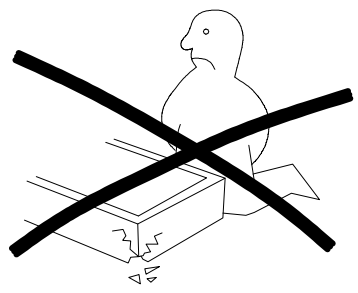
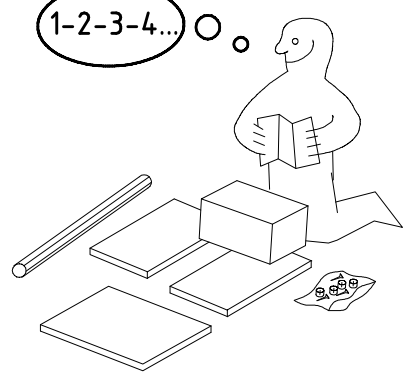

980428

06.08.10 / 29.09.11

09 11

1/4

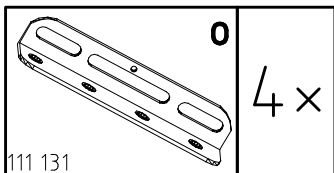

4 x

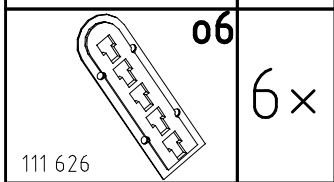

6 x

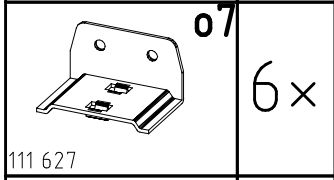

6 x

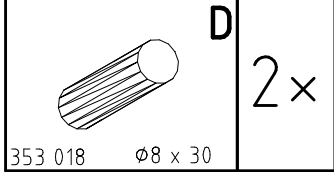

2 x

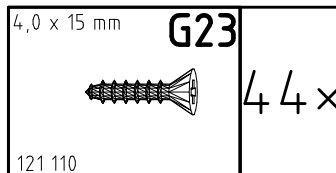

4 4 x

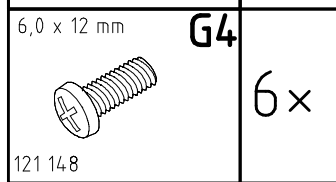

6 x

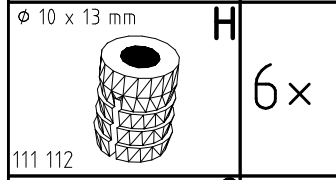

6 x

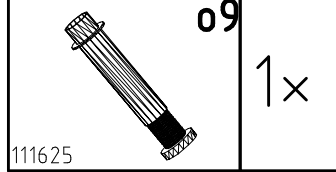

1 x

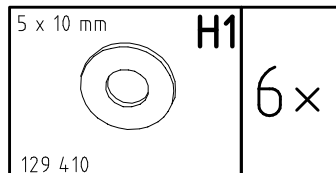

6 x

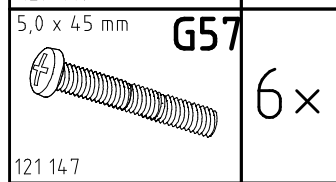

6 x

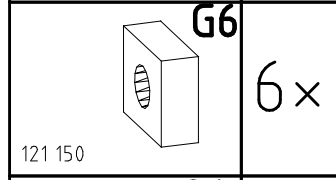

6 x

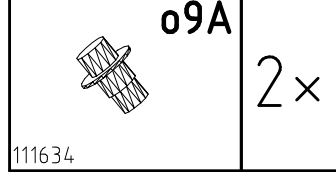

2 x

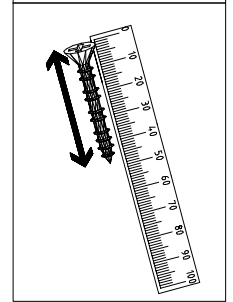
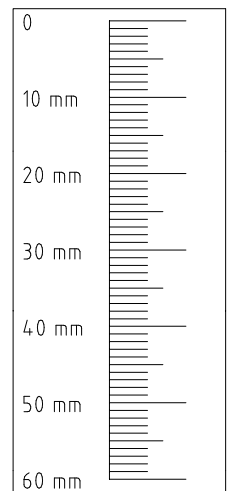

2x (1) 2000x290x22

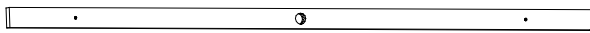

1x (6) 1980x63x25

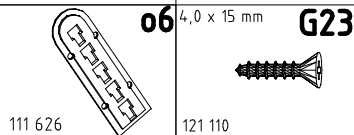
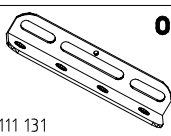
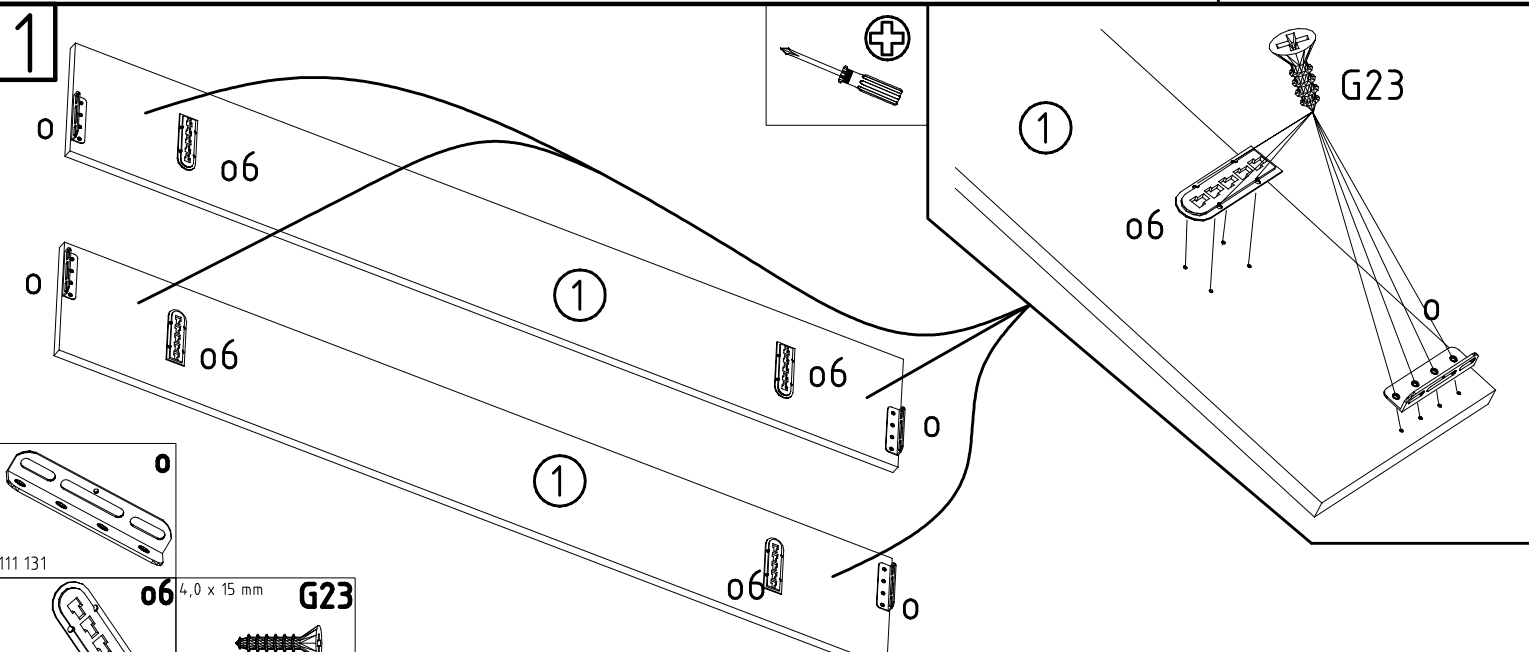
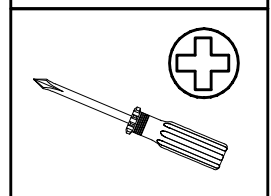
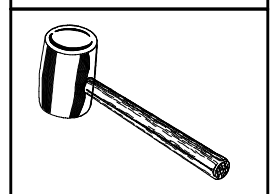
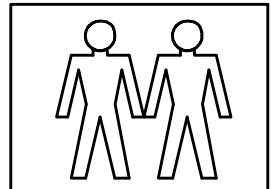
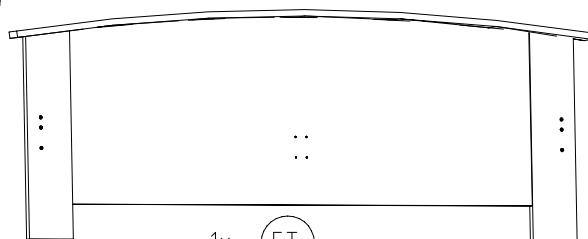
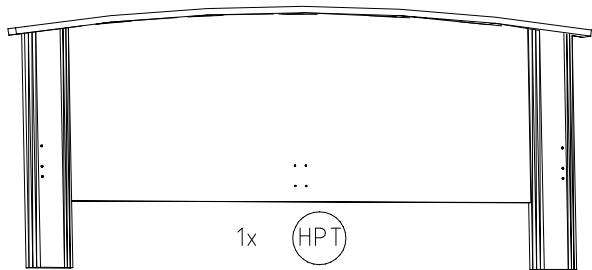

2

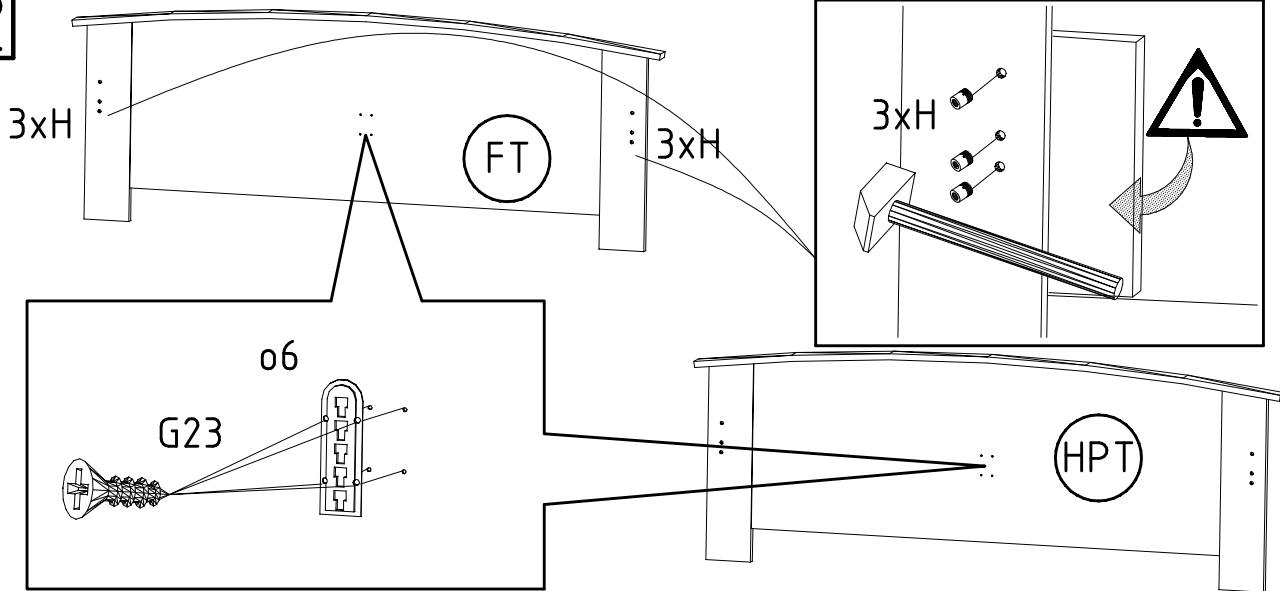

- ø 10 x 13 mm **H**
- 111 112
- 4,0 x 15 mm **G23**
- 121 110
- o6**
- 111 626

3

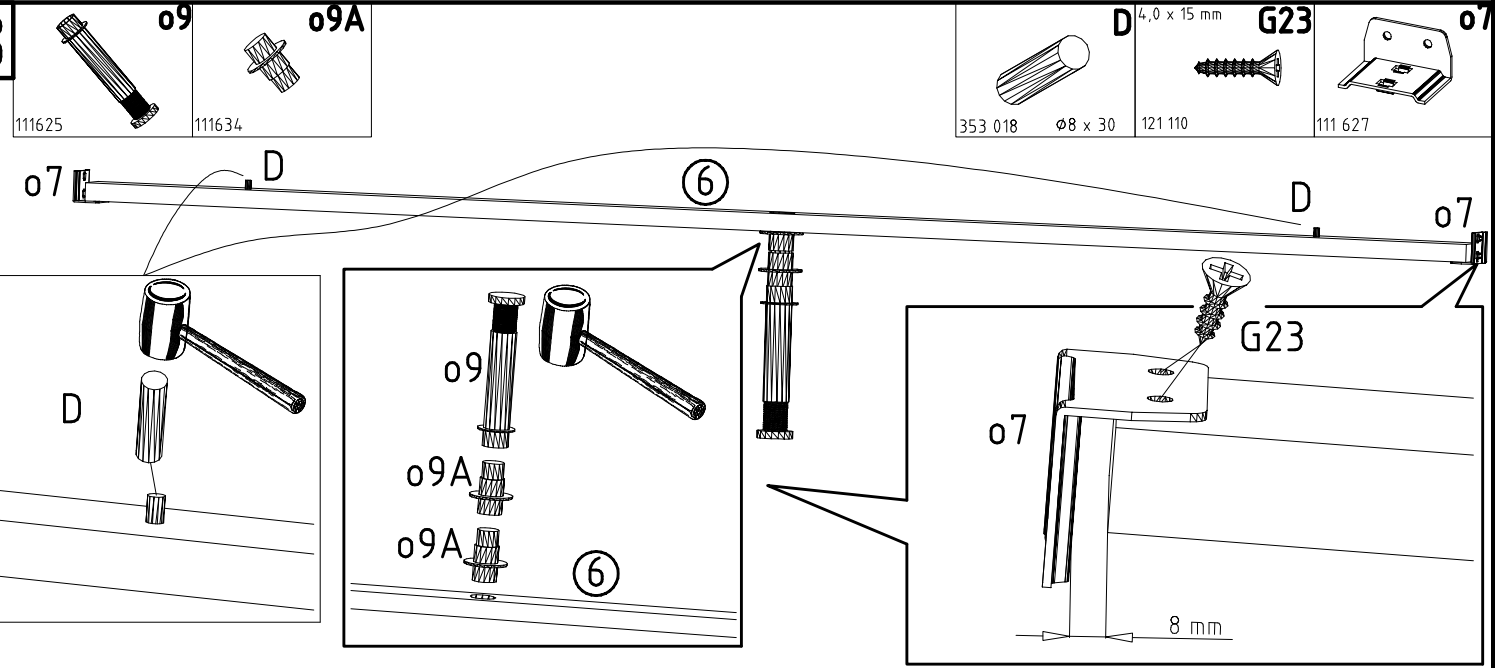

- 111625 **o9**
- 111634 **o9A**
- 353 018 **D** 4,0 x 15 mm **G23**
- ø8 x 30 121 110
- 111 627 **o7**

4

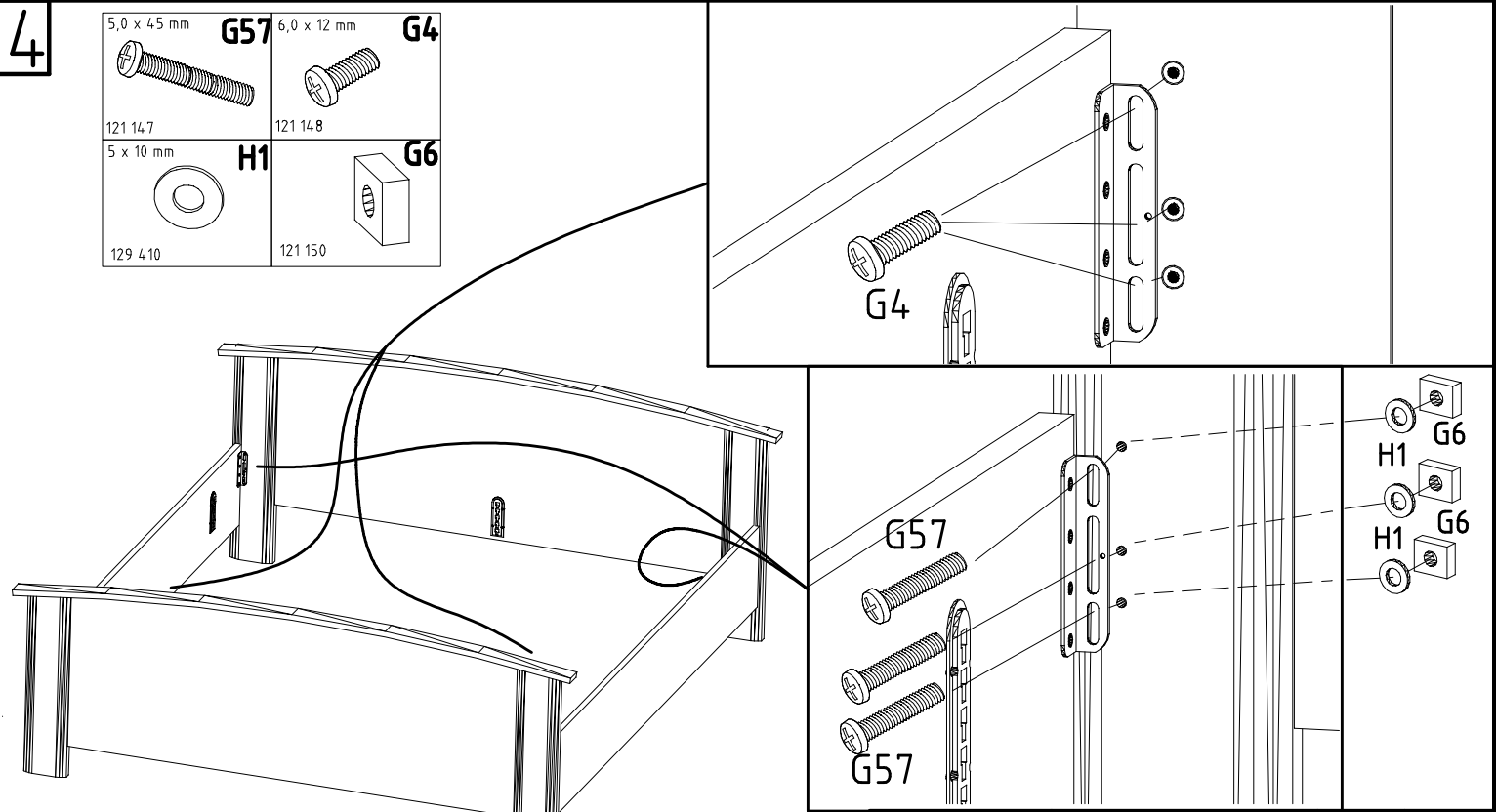

- 5,0 x 45 mm **G57**
- 6,0 x 12 mm **G4**
- 121 147
- 121 148
- 5 x 10 mm **H1**
- G6**
- 129 410
- 121 150

- G57**
- G6**
- H1**
- H1**
- G6**

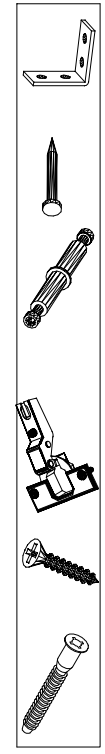
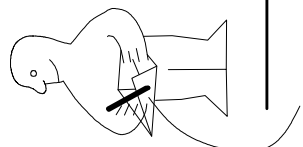
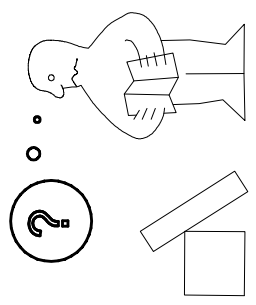
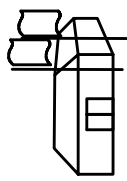
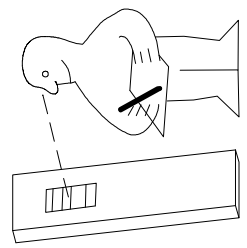
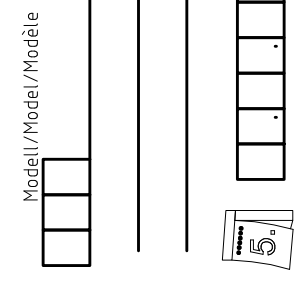
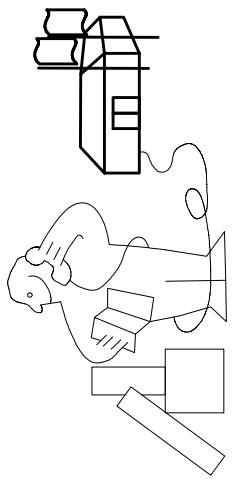
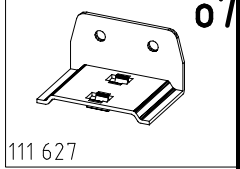
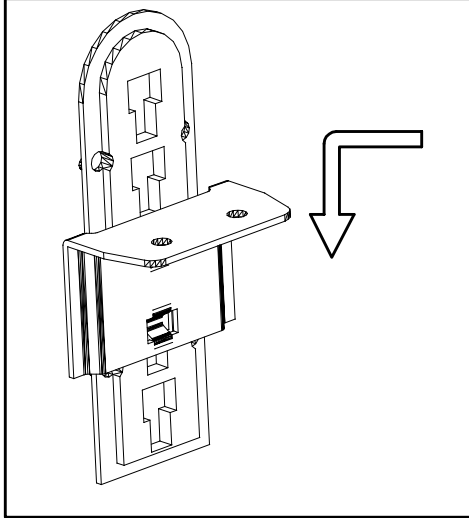
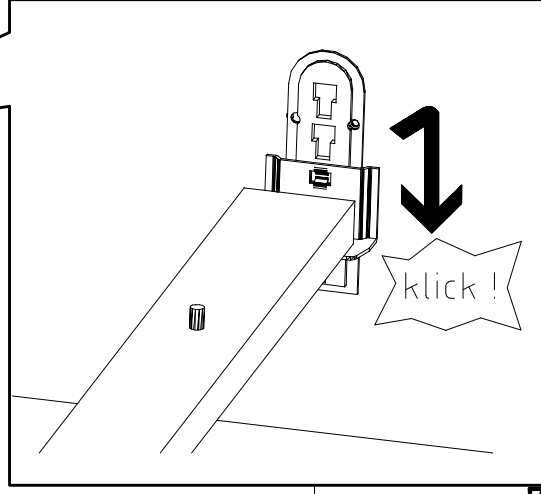
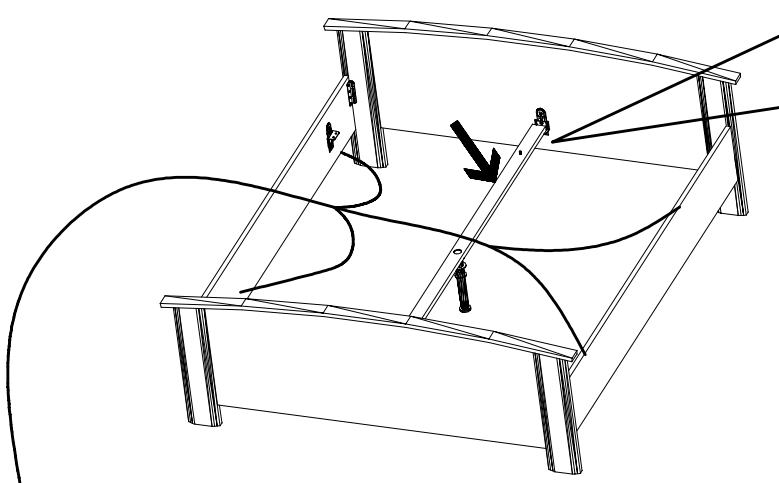

|           |         |      |
|-----------|---------|------|
| (121 370) | ( G 1 ) | (4x) |
|           |         |      |
|           |         |      |
|           |         |      |
|           |         |      |

Änderungen die dem technischen Fortschritt geschuldet sind, behalten wir uns vor!  
 Bei nicht vorschriftsmäßiger und/ oder nicht fachmännischer Montage wird bei Personen- und/ oder Sachschäden keinerlei Haftung übernommen.

WIMEX Wohnbedarf/ Import Export Handels GmbH/ Postfach 1407/ 49112 Georgsmarienhütte/ Germany  
 Tel.:(+49) 054-01 8598 16/17 Fax.:(+49) 054-01 8598 33 Mail: info@wimex-wohnbefarf.de