

# Ornella

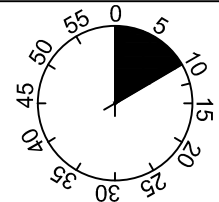

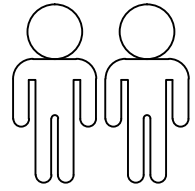

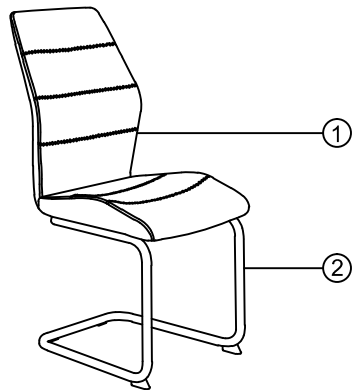
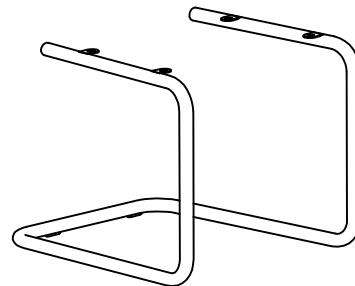
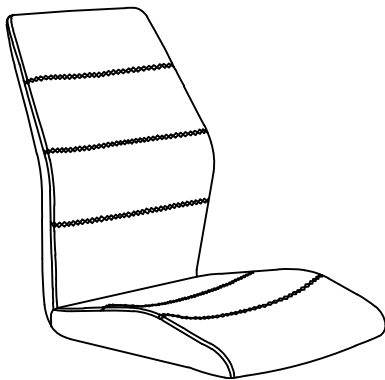

1

2







1	1x
2	1x

A	M6x20	B	Ø18xØ6x1.5	C	4MM	D	M4x20	E	
									
4x		4x		1x		4x		2x	

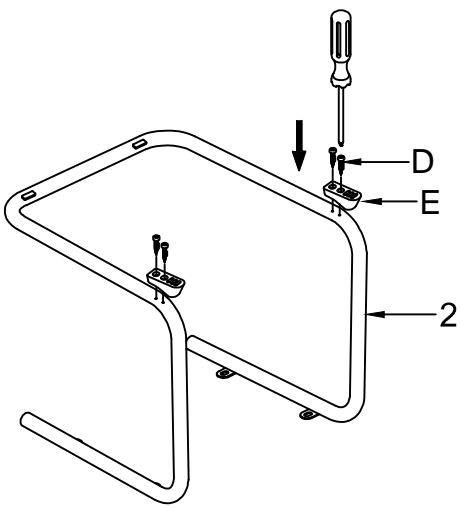
I.





1

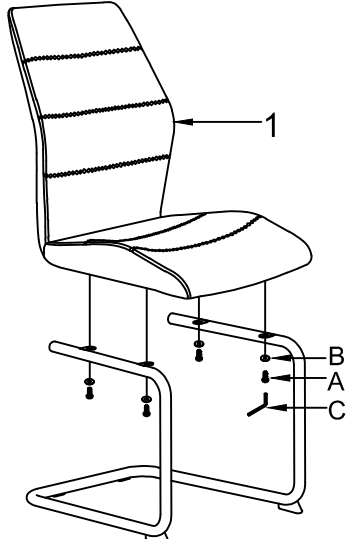

- D M4x20  
 4x
- E  
 2x
- 

2



- A M6X20  
 4x
- B Ø18xØ6x1.5  
 4x
- C 4MM  
 1x
- 

3

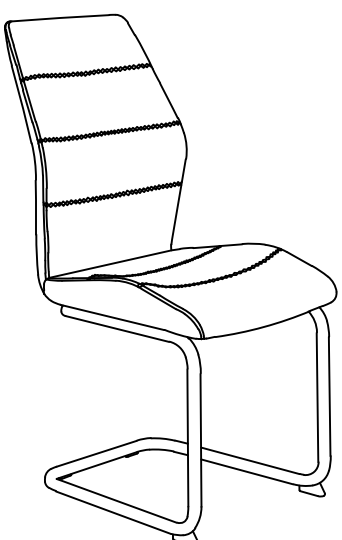

- C 4MM  
 1x
- 