

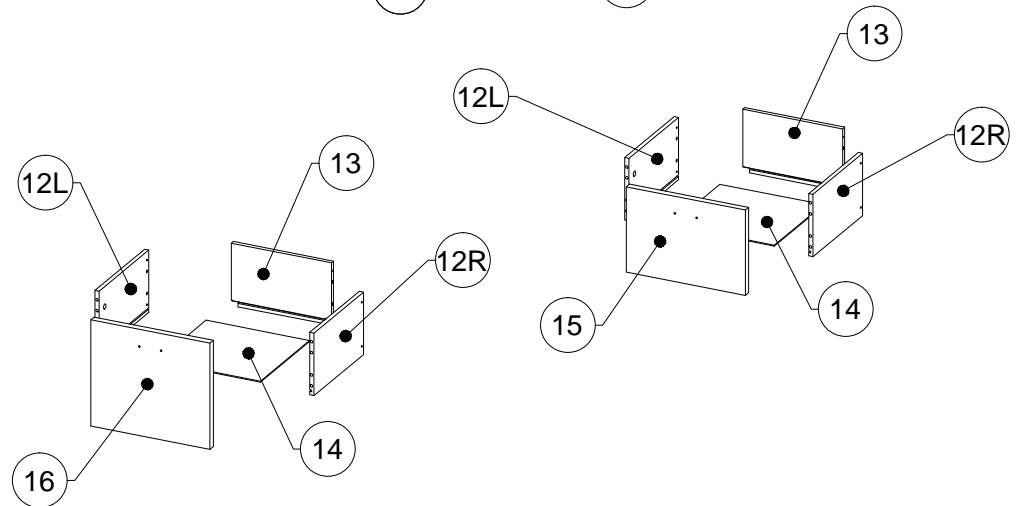

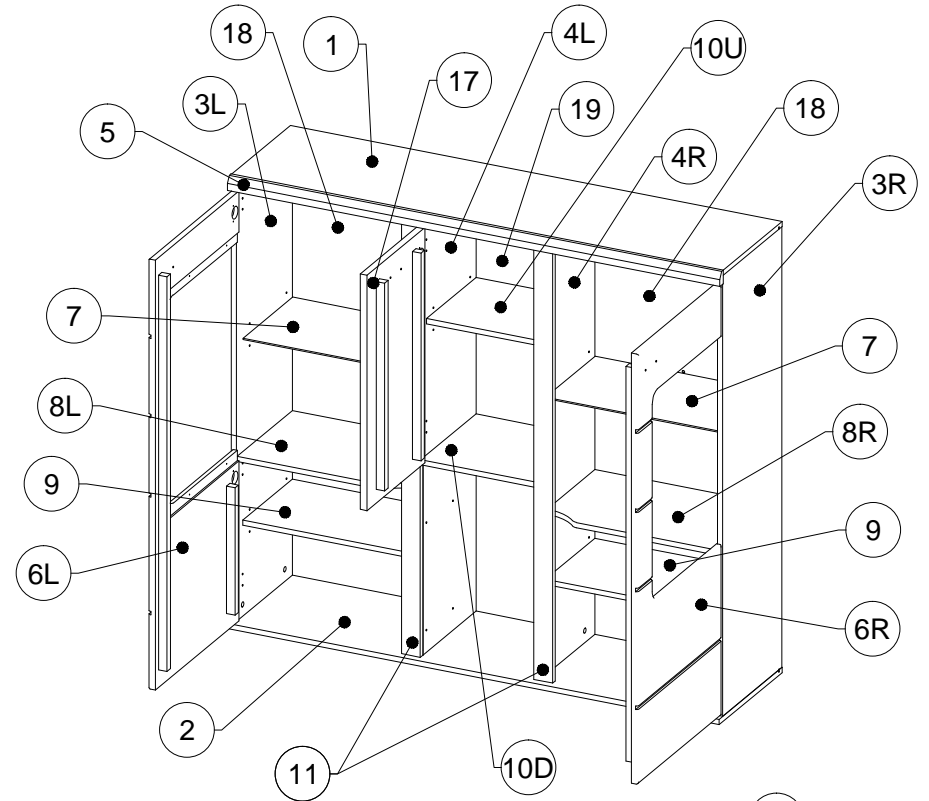

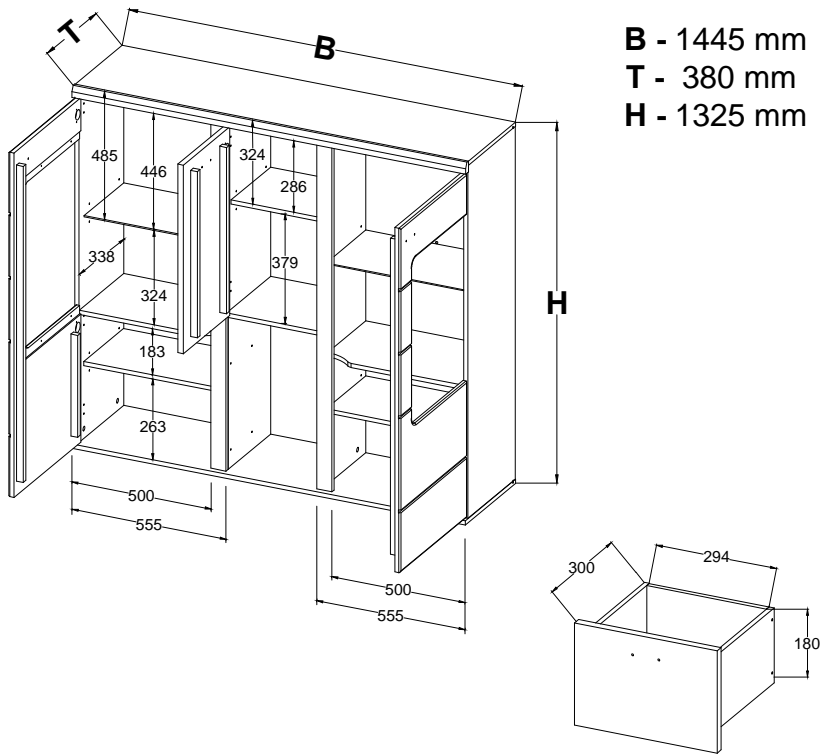

SONOS 1L-17HU-22

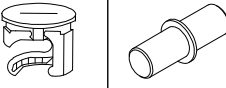
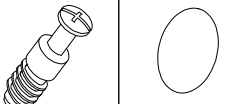
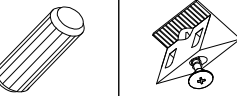
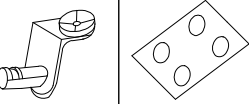
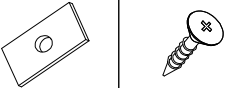
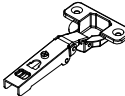

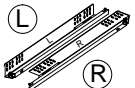

1	1445	358	15	1
2	1445	380	22	1
3L, 3R	1273	358	15	2
4L, 4R	1273	322	15	2
5	1447	40	20	1
6L, 6R	1242	506	20	2
7	523	300	4	2
8L, 8R	525	335	15	2
9	524	300	15	2
10U	333	300	15	1
10D	333	335	15	1
11	1273	55	16	2
12L, 12R	300	180	12	4
13	294	180	12	2
14	304	297	3	2
15	350	246	20	1
16	350	306	20	1
17	680	350	20	1
18	1283	536	3	2
19	1283	348	3	1

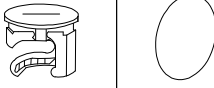

Ø15x12mm			
A	x36	E2	x12
			
C	x44	G	x36
Ø8x30mm			
D	x56	H	x22
			
E1	x8	P	x2
		Ø3x16mm	
I	x12	I1	x12

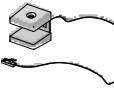
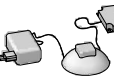

	
K	x8
	
K2	x8
Ø3,5x13mm	
	
K1	x16

L-300mm		Ø3,5x13mm	
			
J	x2	J2	x8
Ø6x11mm			
J1	x8	H	x4
Ø15x10mm			
B	x8	G1	x8
Ø3,5x30mm			
F	x8		

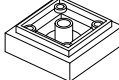
L-80mm	
	
L	x5
M4x25mm	
	
L1	x10

	
U	x2
	
U1	x1

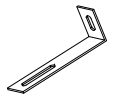
55x55x20	
	
M	x6
Ø4x30mm	
	
M1	x24

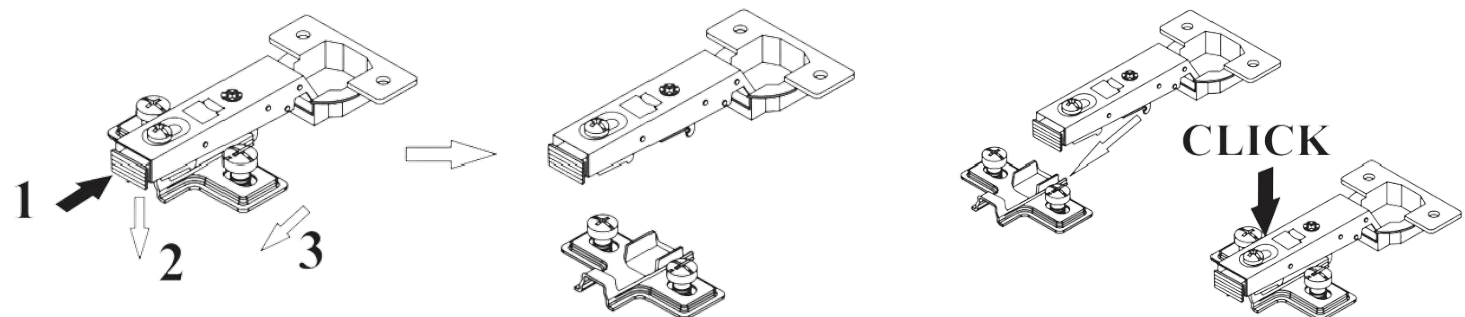

	
O	x2
	
O1	x2
Ø3,5x13mm	
	
O2	x4



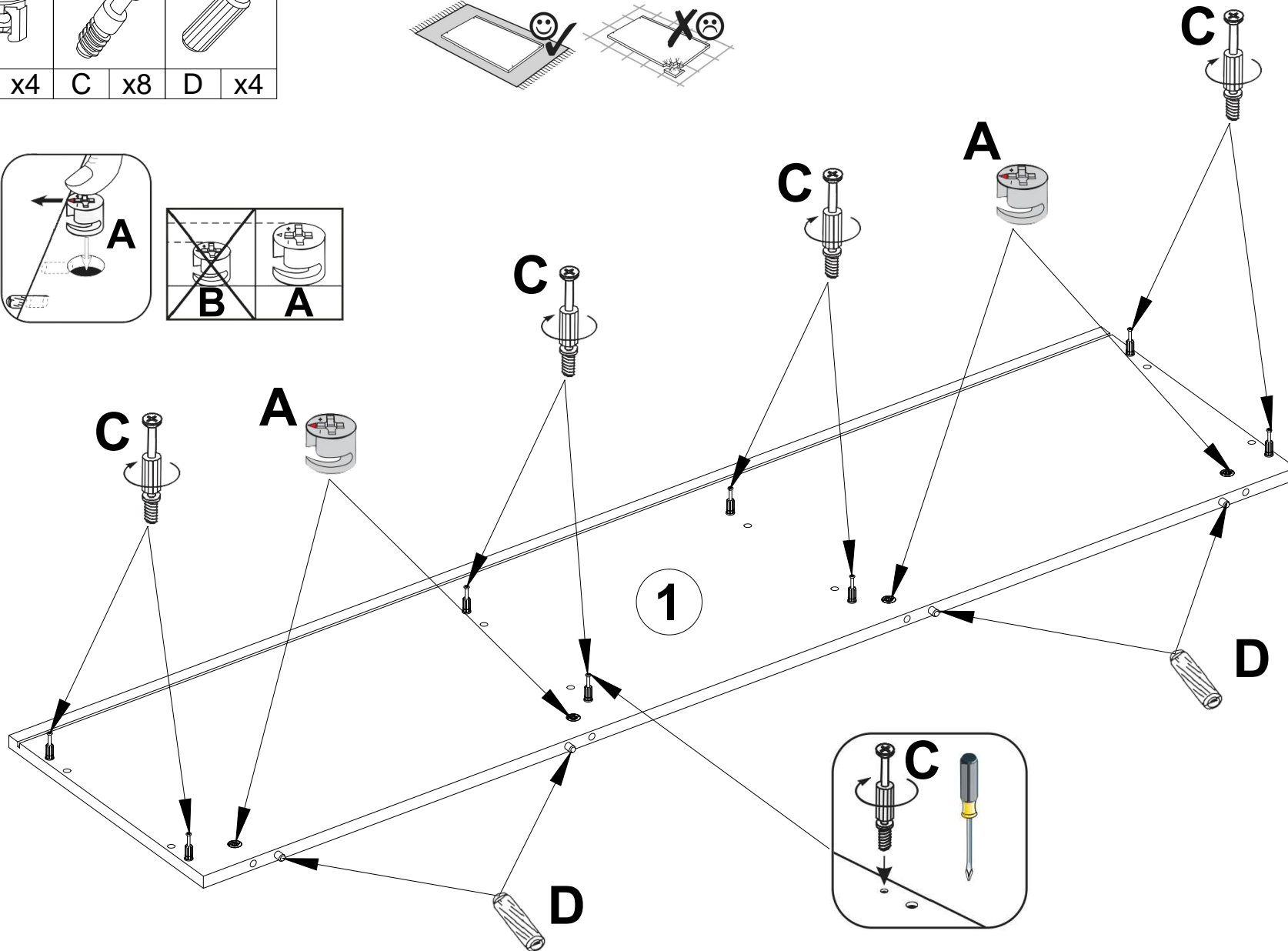
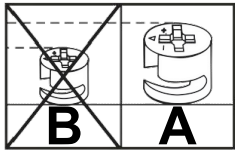
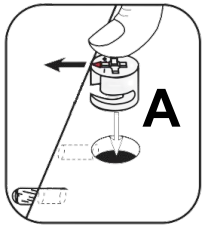
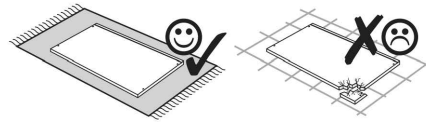



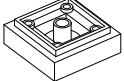

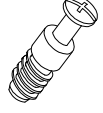
Ø15x12mm		Ø8x30mm
A x4	C x8	D x4

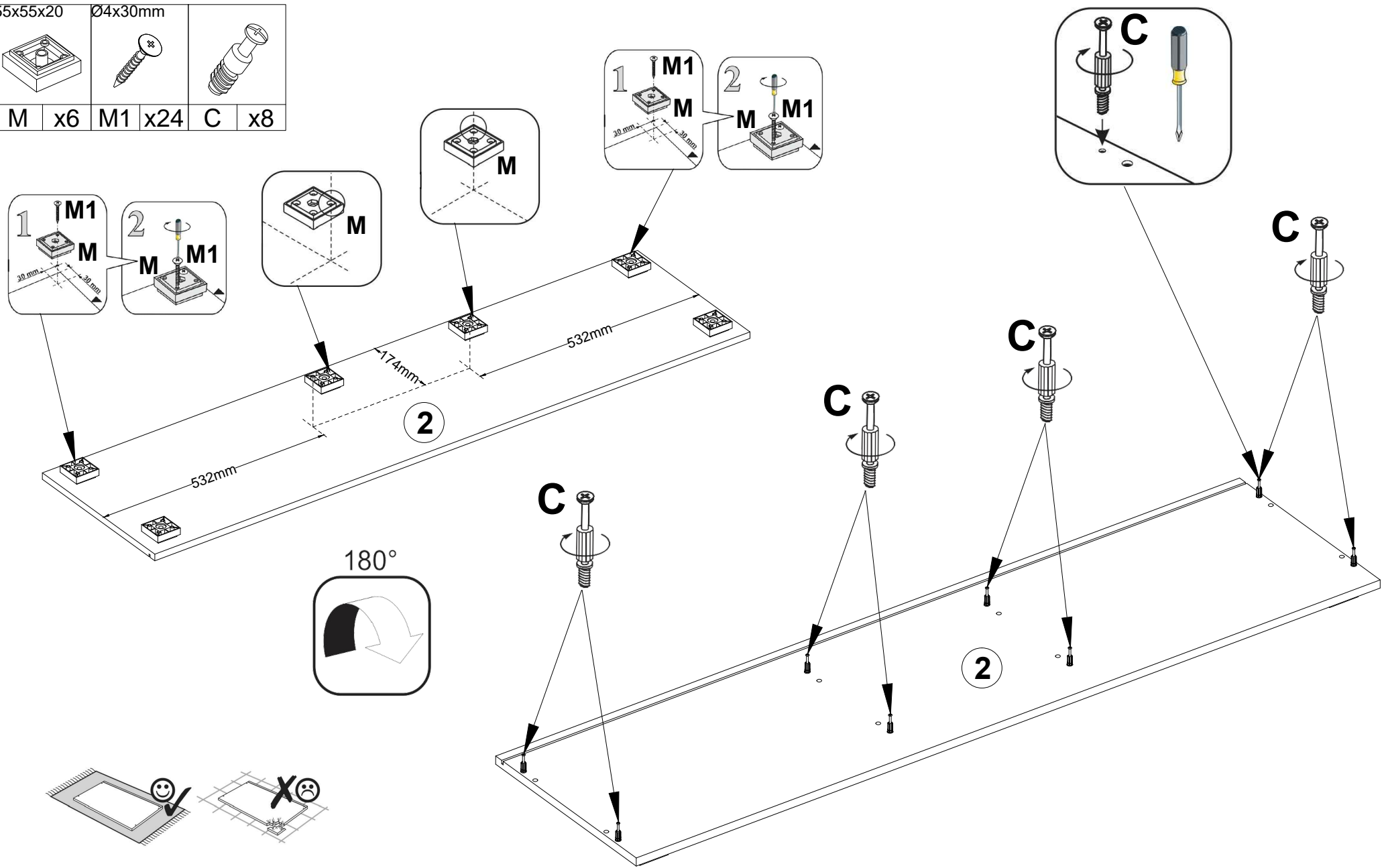

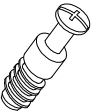

SONOS 1L-17HU-22

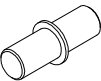
55x55x20	Ø4x30mm	
		
M x6	M1 x24	C x8



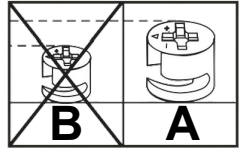
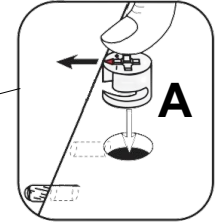
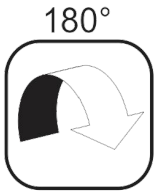
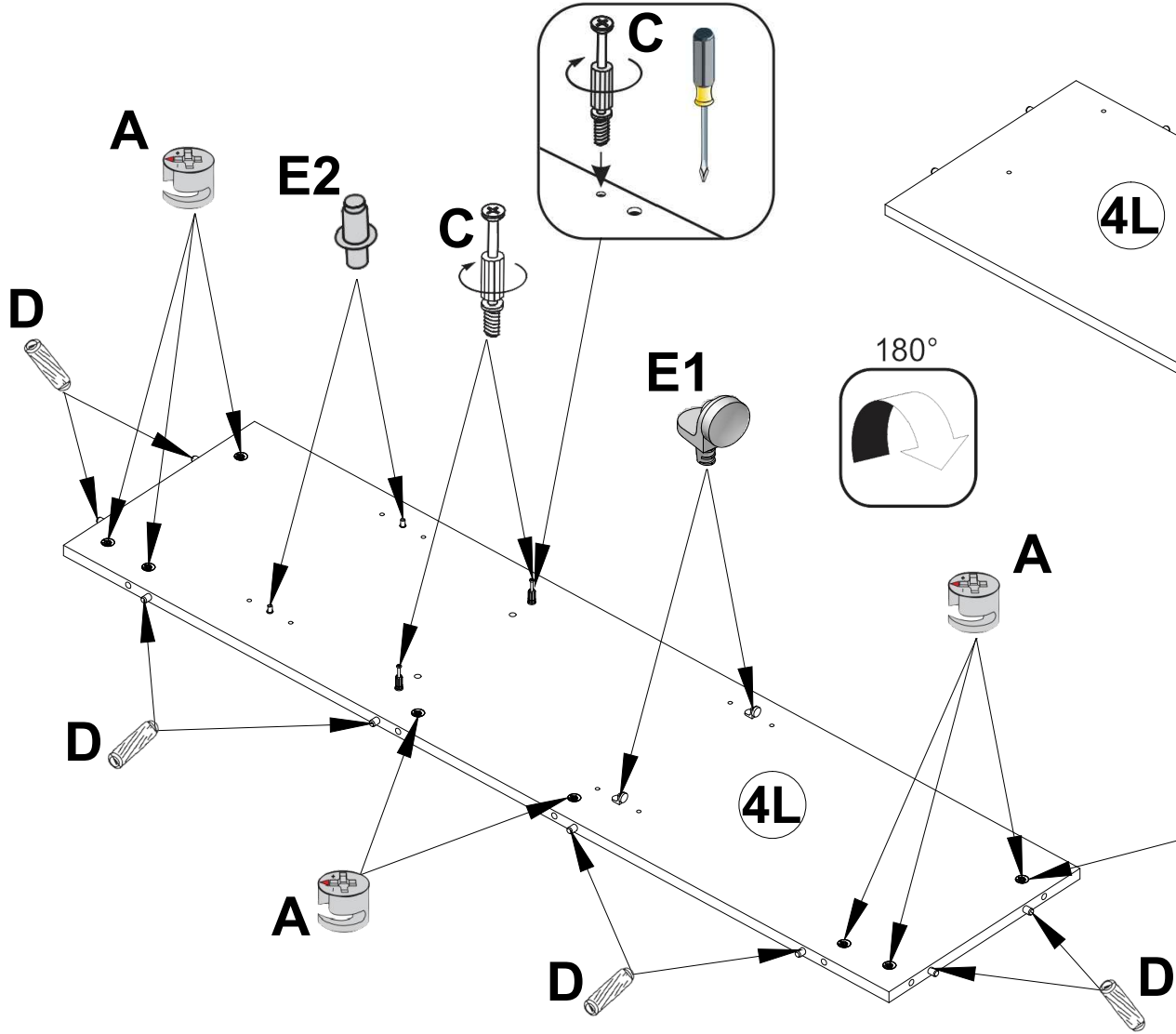
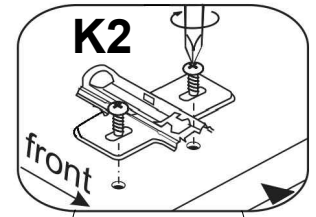
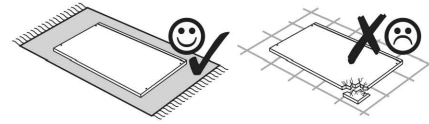



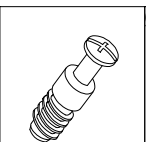
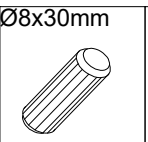
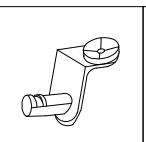
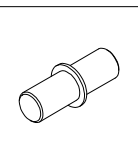

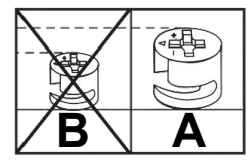
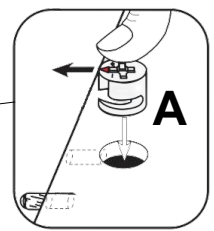
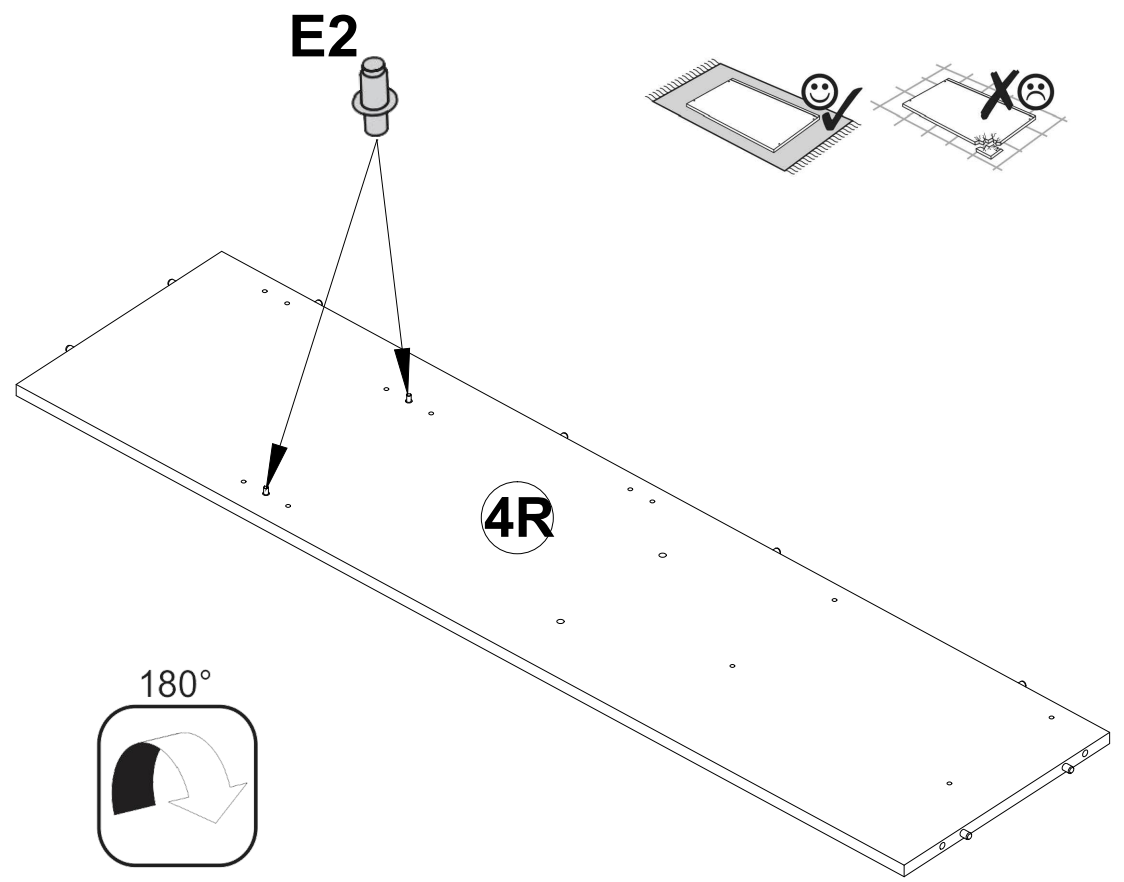
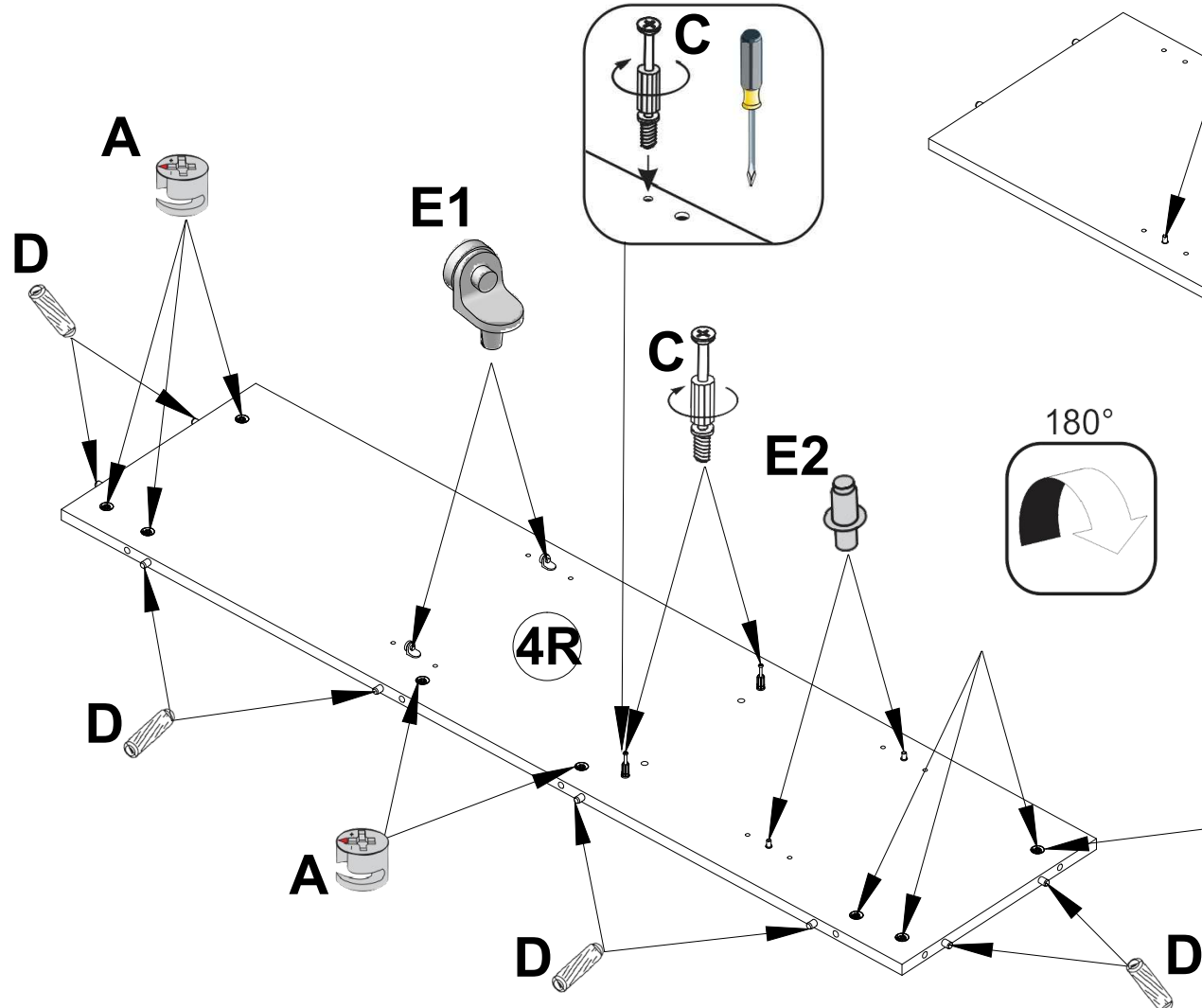
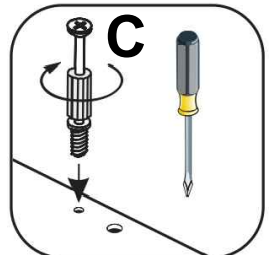
Ø15x12mm		Ø8x30mm				
						
A x8	C x2	D x8	E1 x2	E2 x4	K2 x2	







 <p>Ø15x12mm</p>	 <p>Ø8x30mm</p>	 <p>Ø8x30mm</p>		
A x8	C x2	D x8	E1 x2	E2 x4

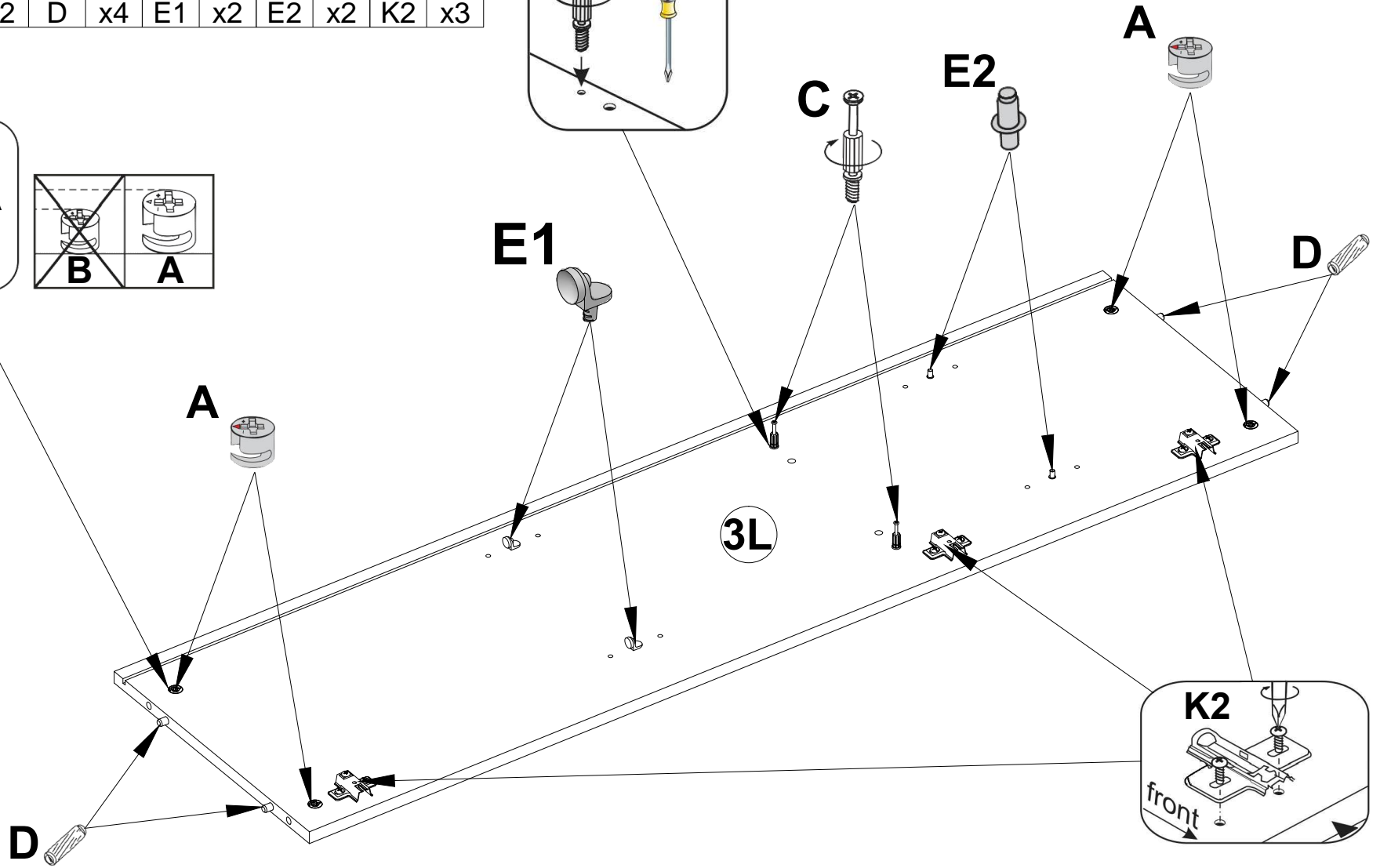
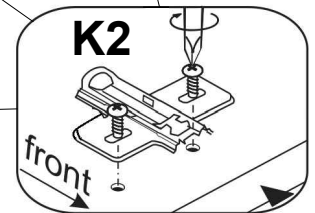
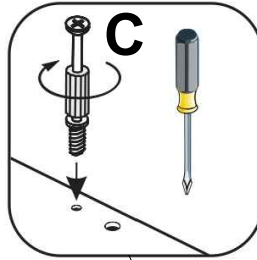
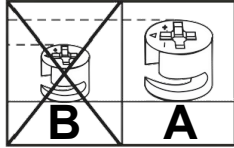
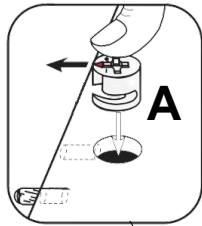
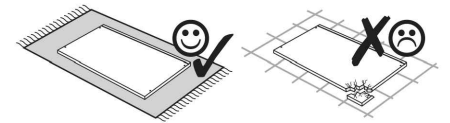

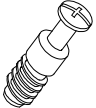

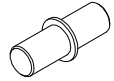
											
A	x4	C	x2	D	x4	E1	x2	E2	x2	K2	x3



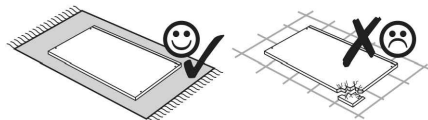
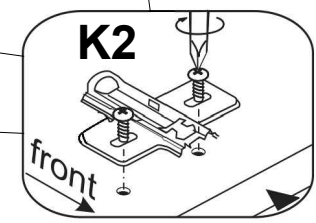
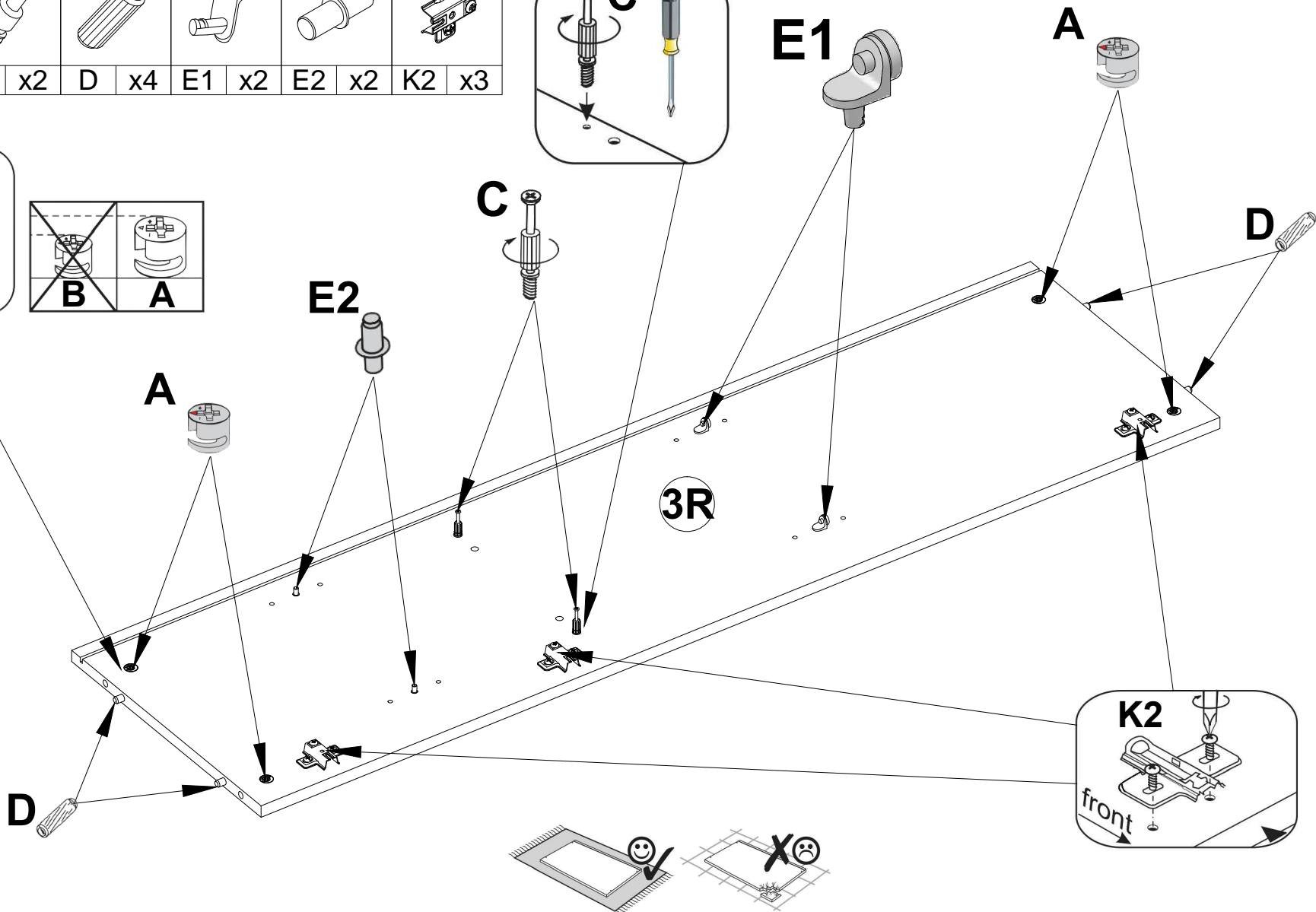
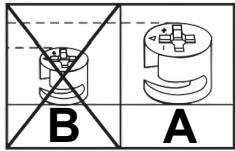
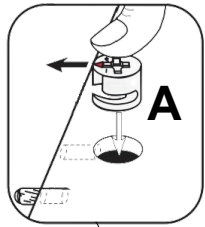
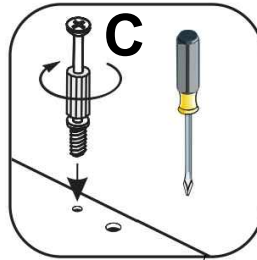

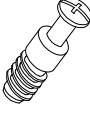
Ø15x12mm		Ø8x30mm			
					
A x4	C x2	D x4	E1 x2	E2 x2	K2 x3

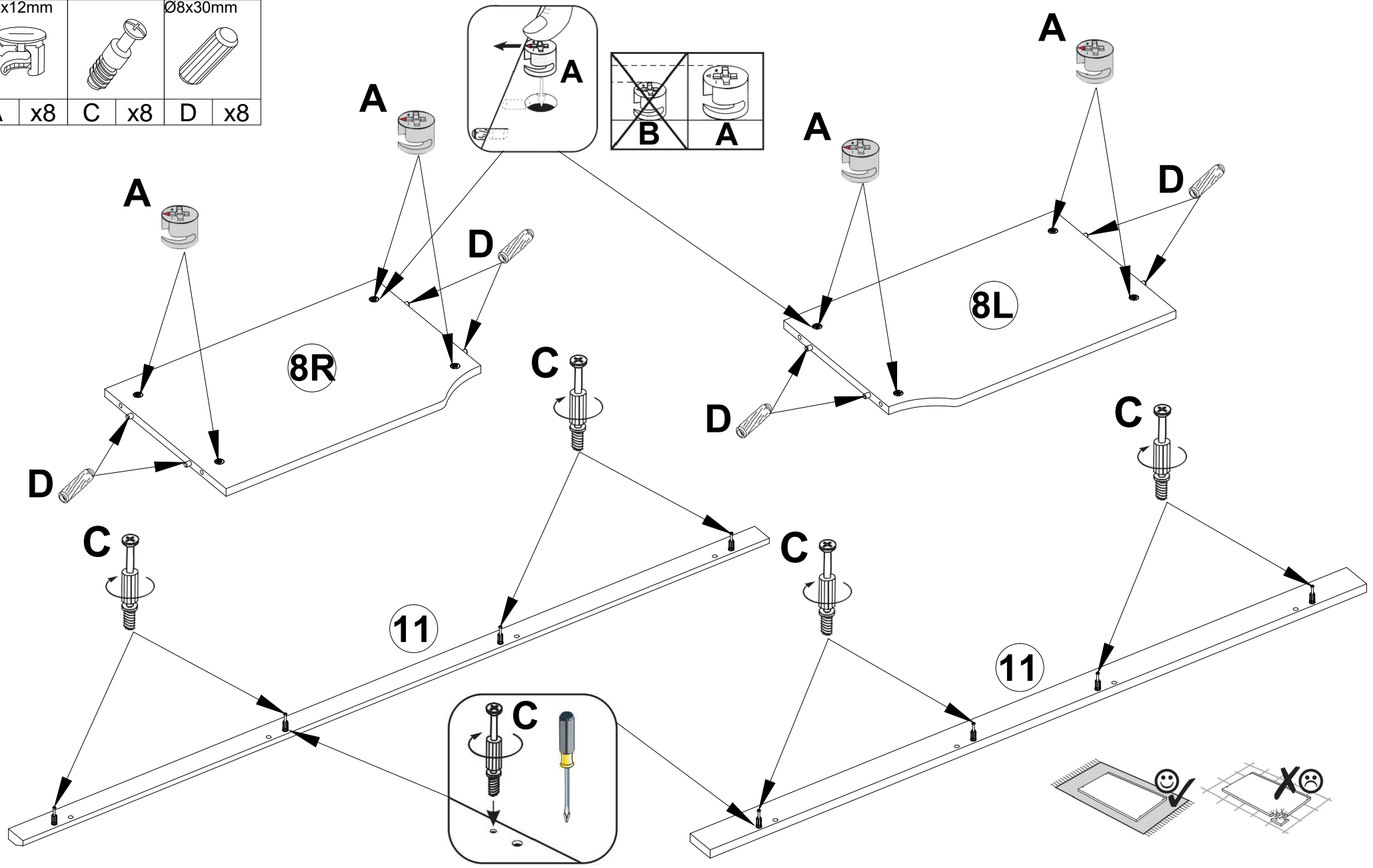

Ø15x12mm		Ø8x30mm
		
A x8	C x8	D x8

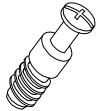
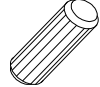

	Ø8x30mm		Ø15x10mm
C	x4	D	x8
			B
			x4

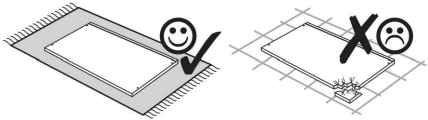
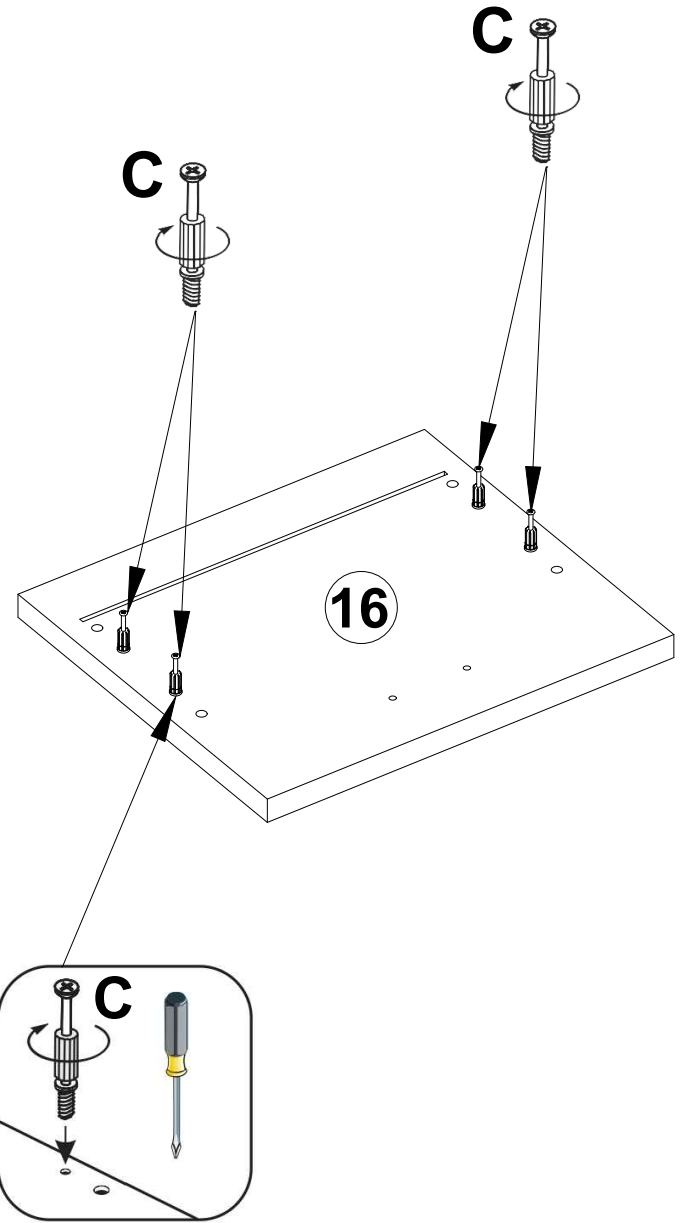
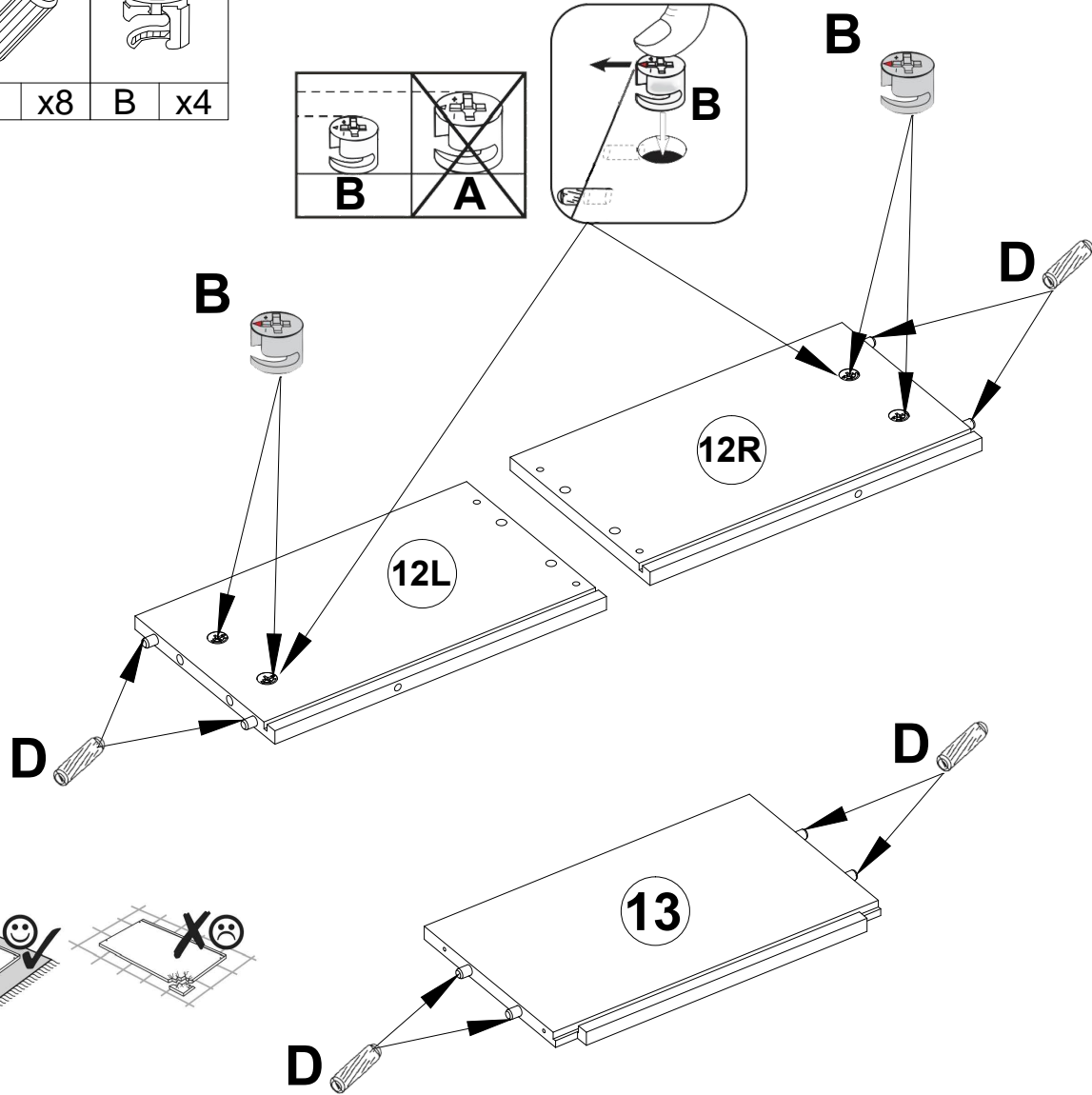
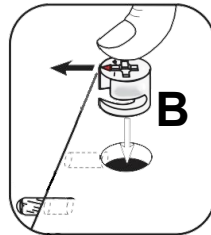
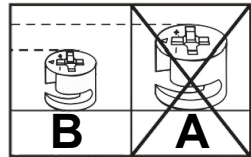

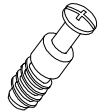
	Ø8x30mm	Ø15x10mm
C	x4	D x8
		B x4

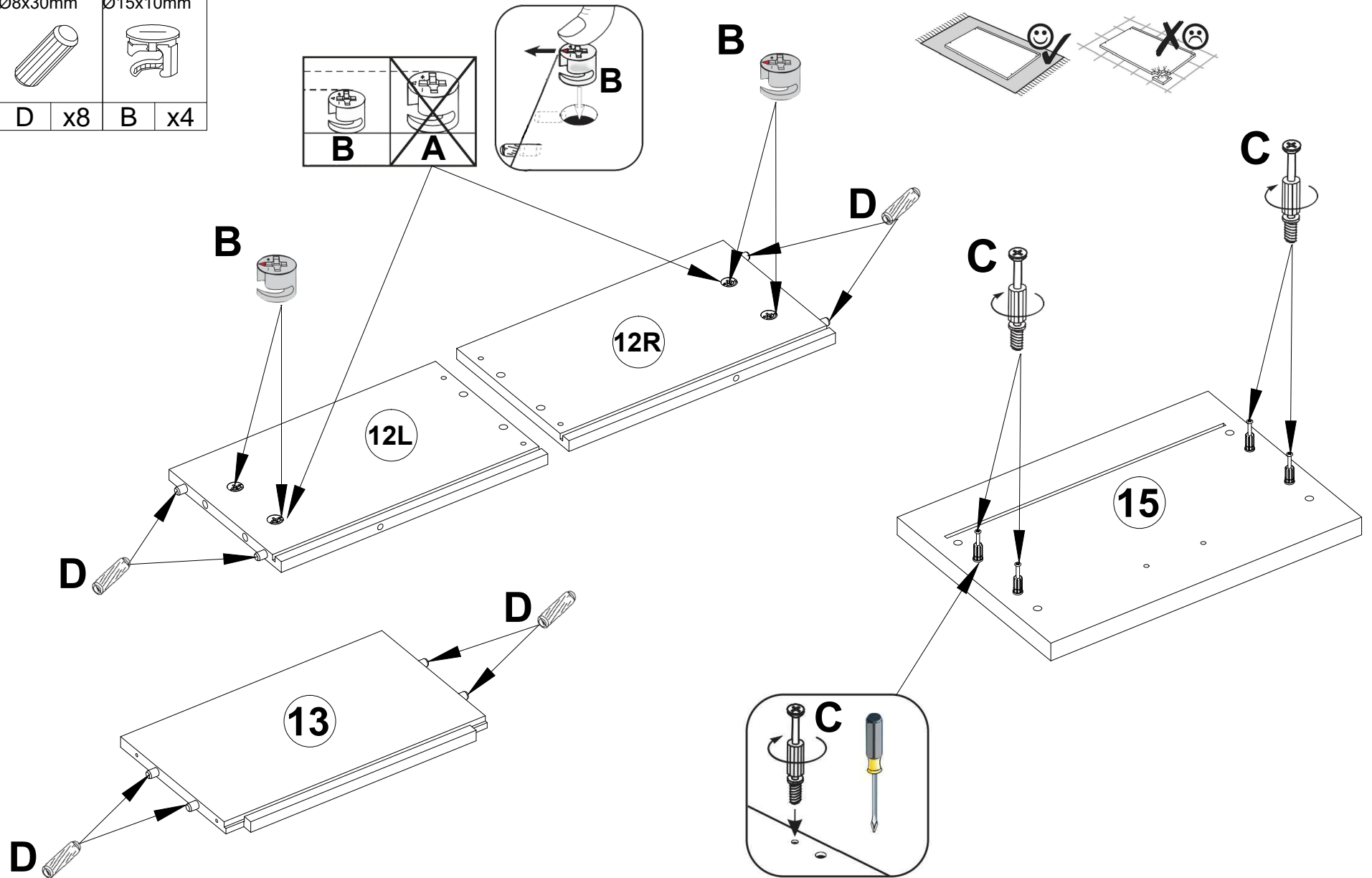

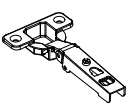
	Ø3,5x13mm	Ø8x30mm			
K	x8	K1	x16	D	x4

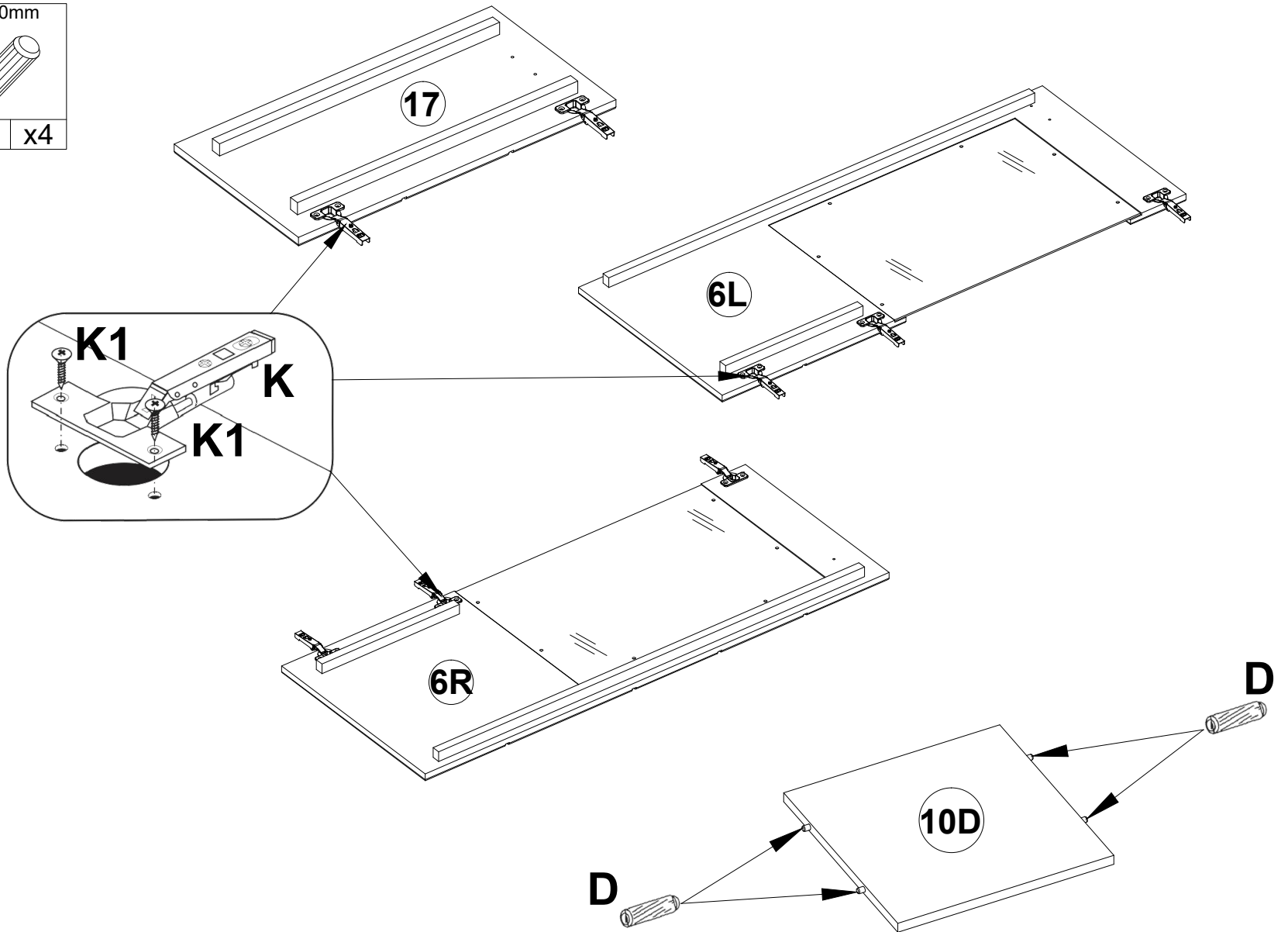

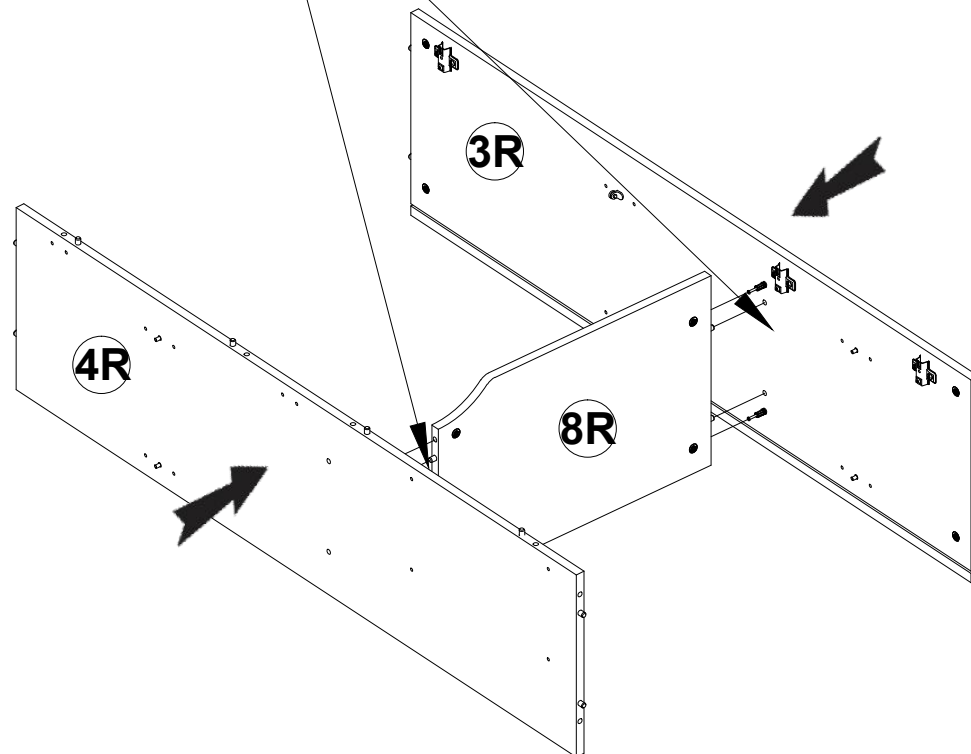
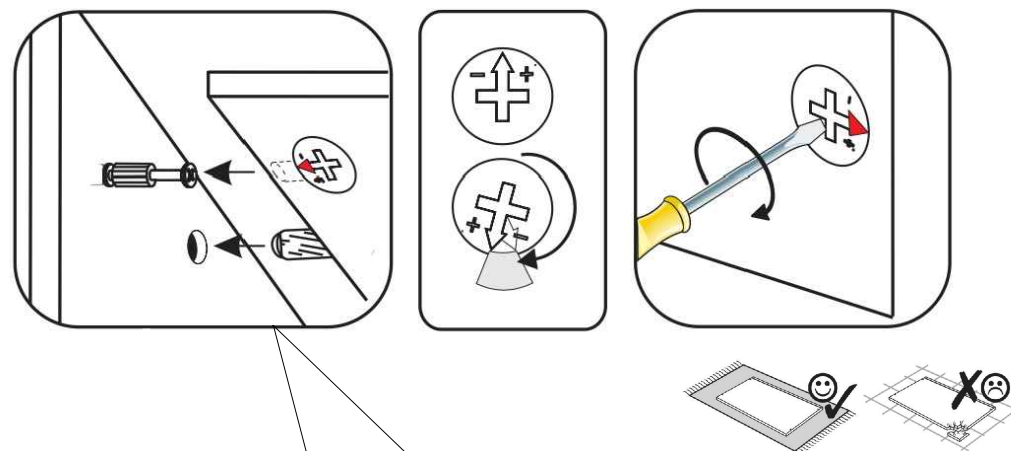
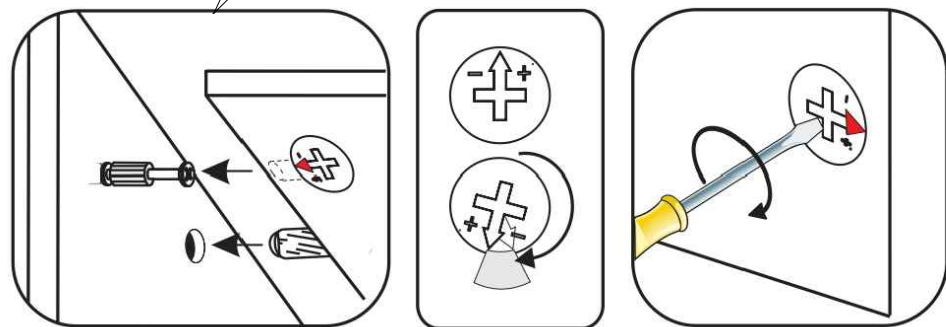
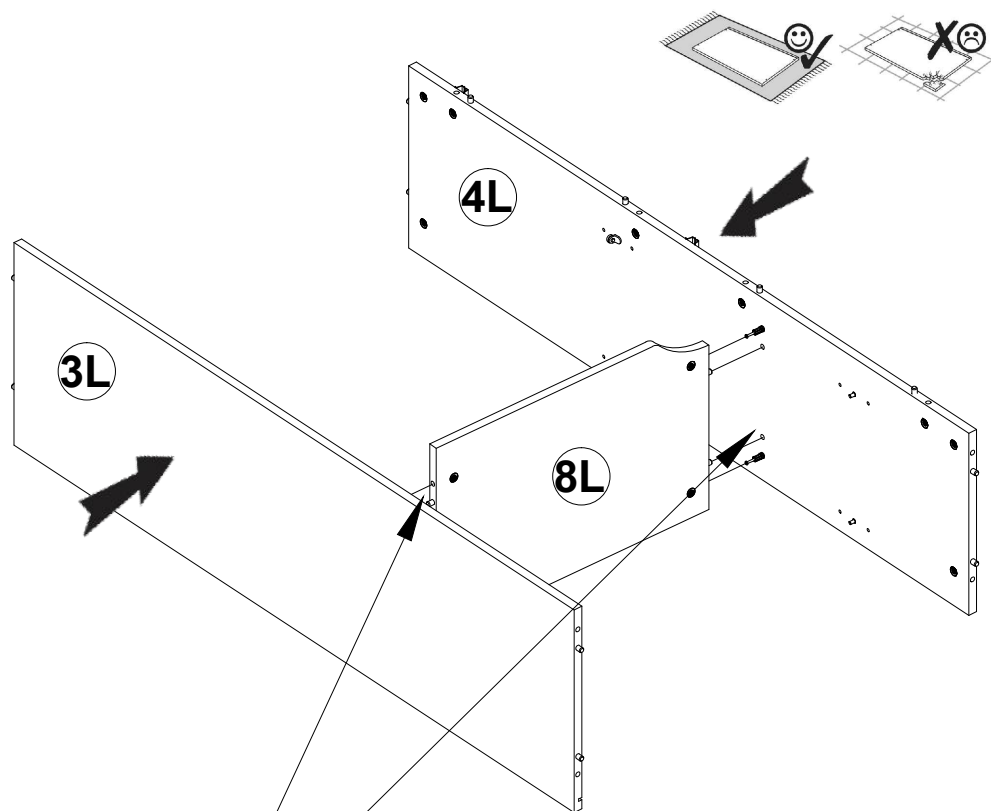

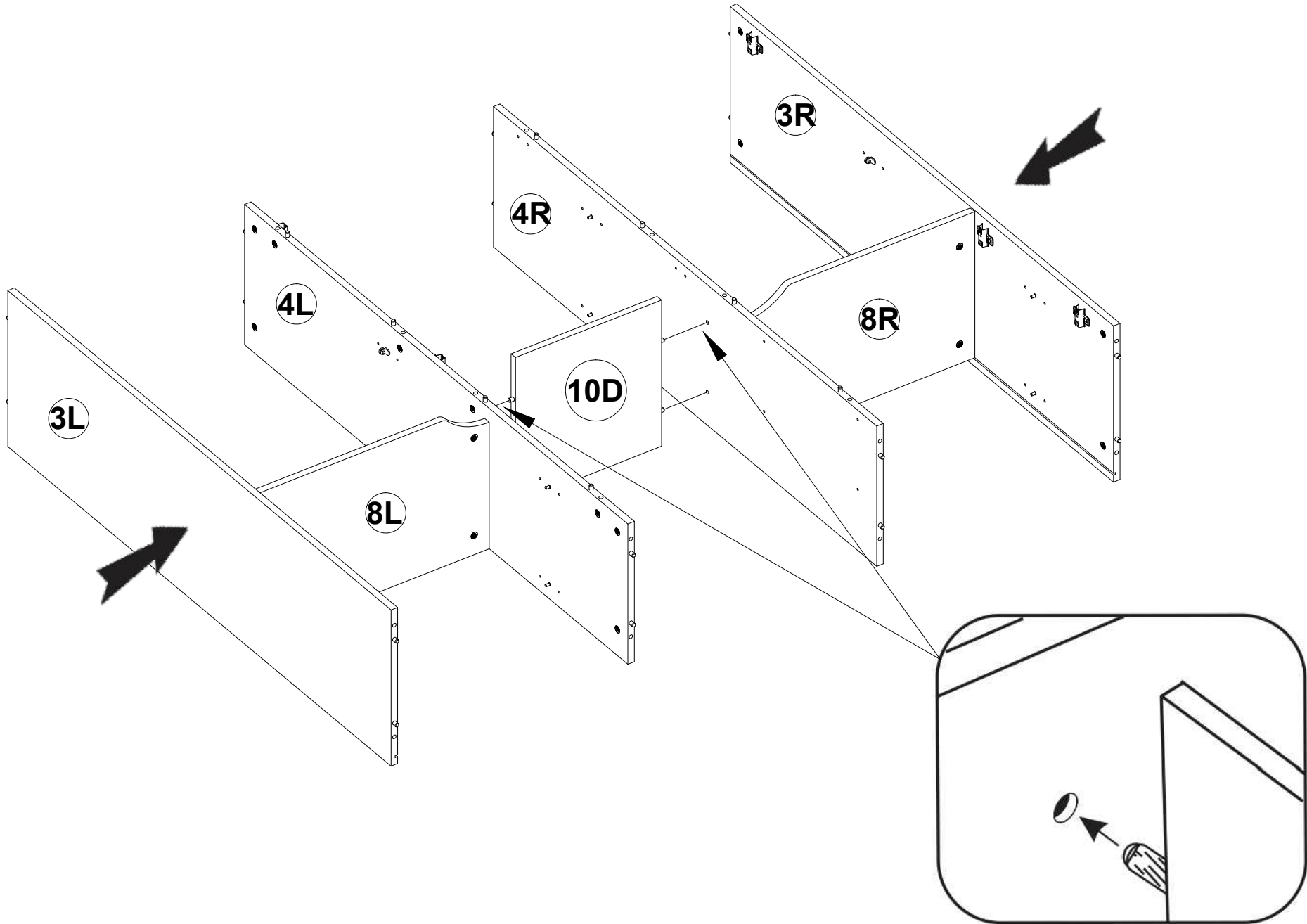

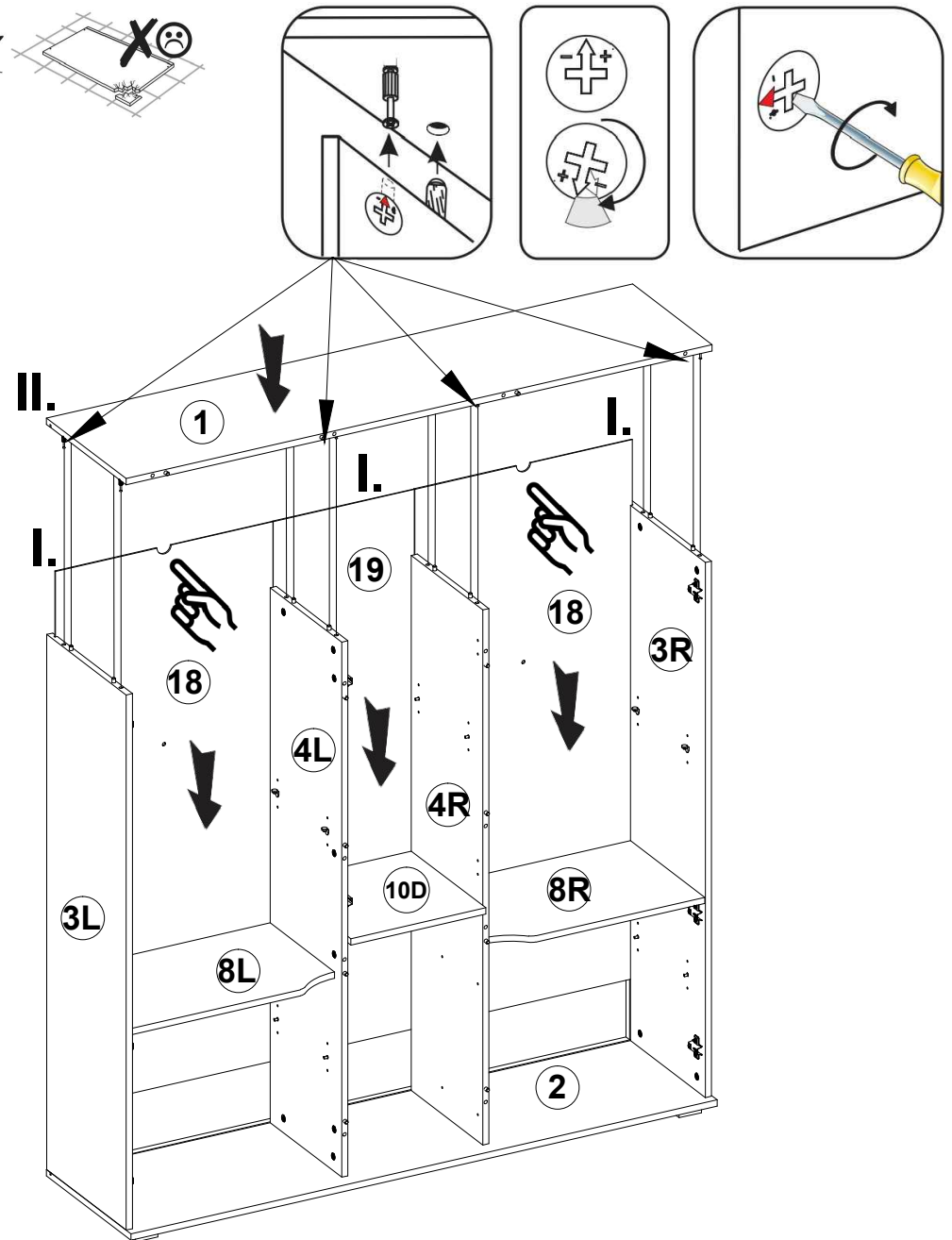
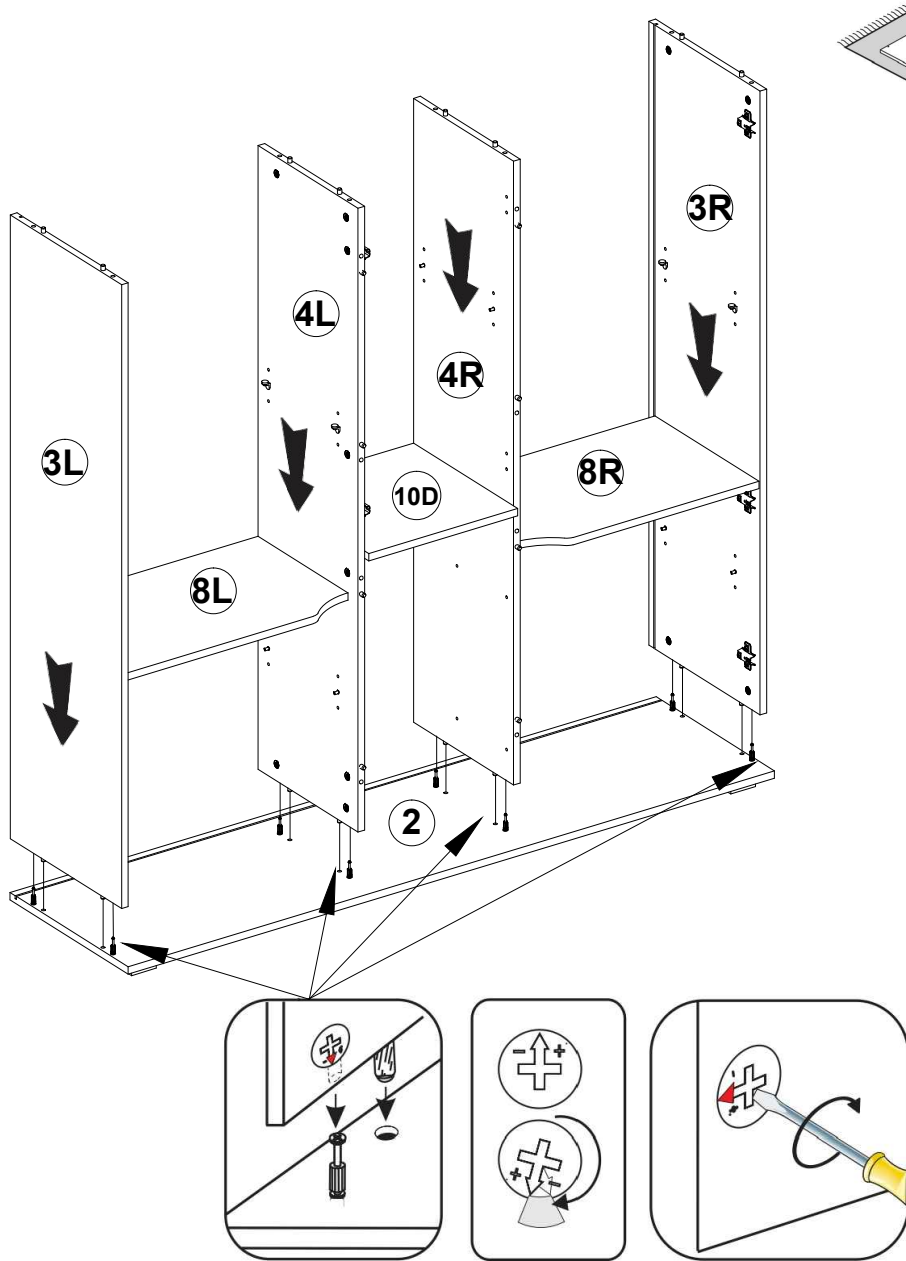

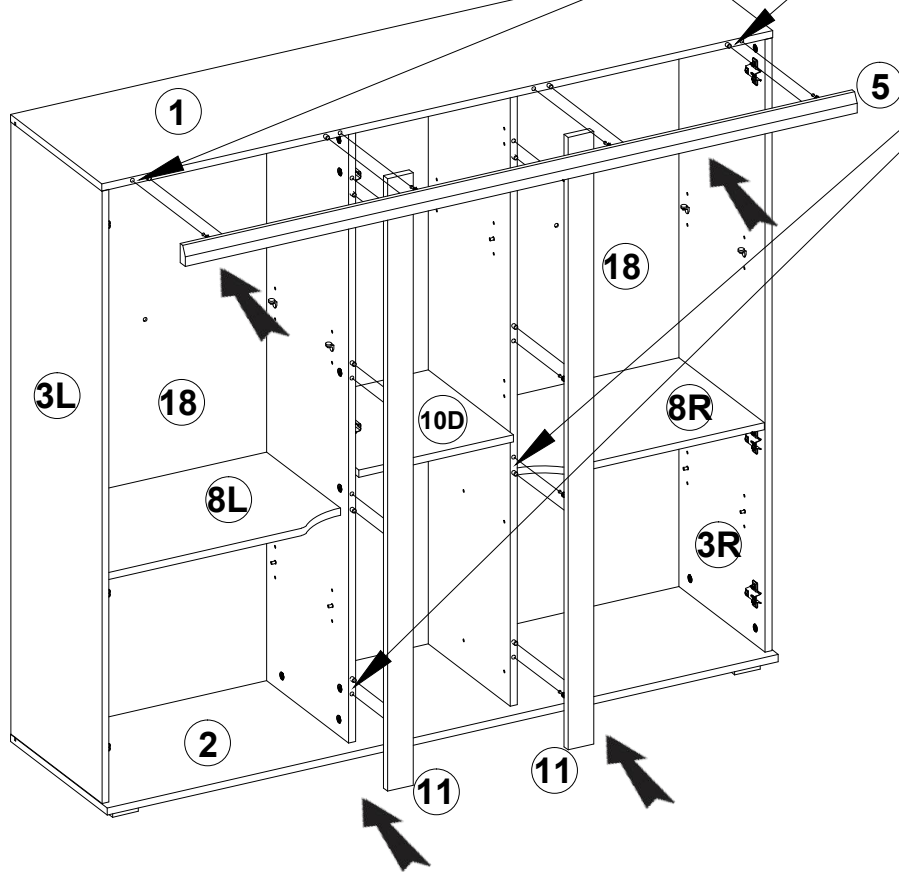
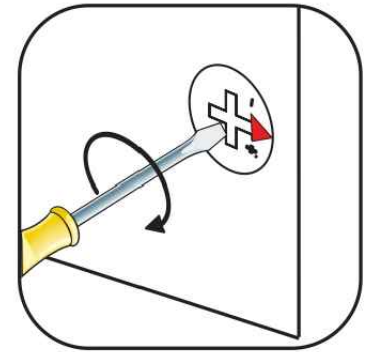
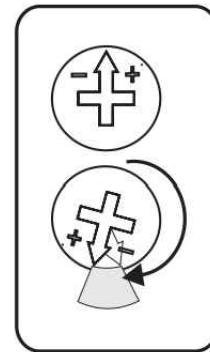
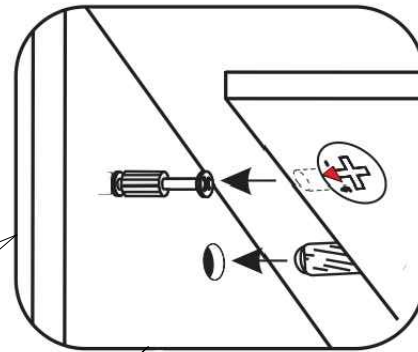
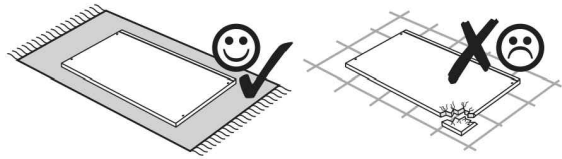

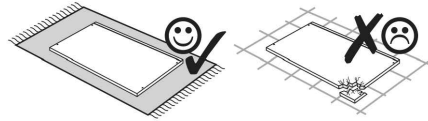

A=B

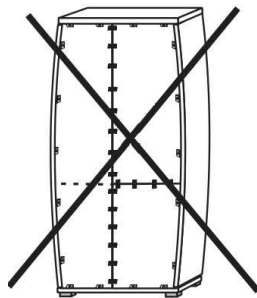
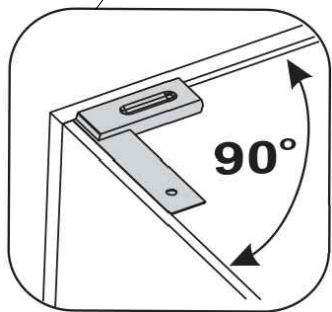
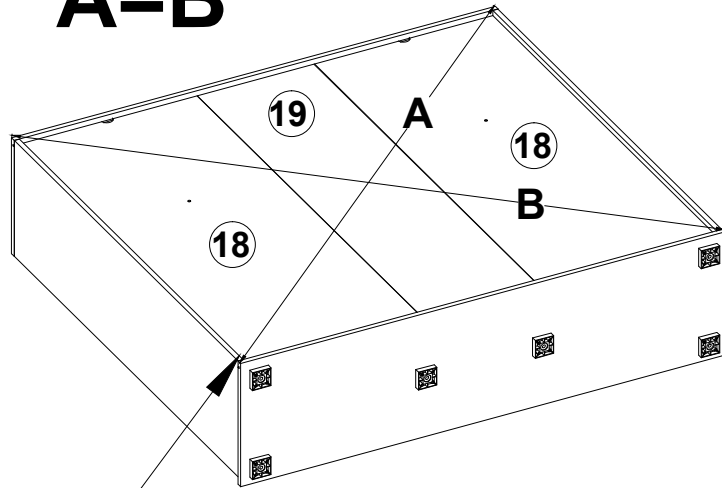

		Ø3x16mm			
I	x12	I1	x12	H	x22

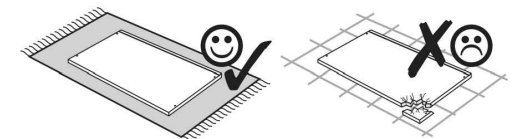
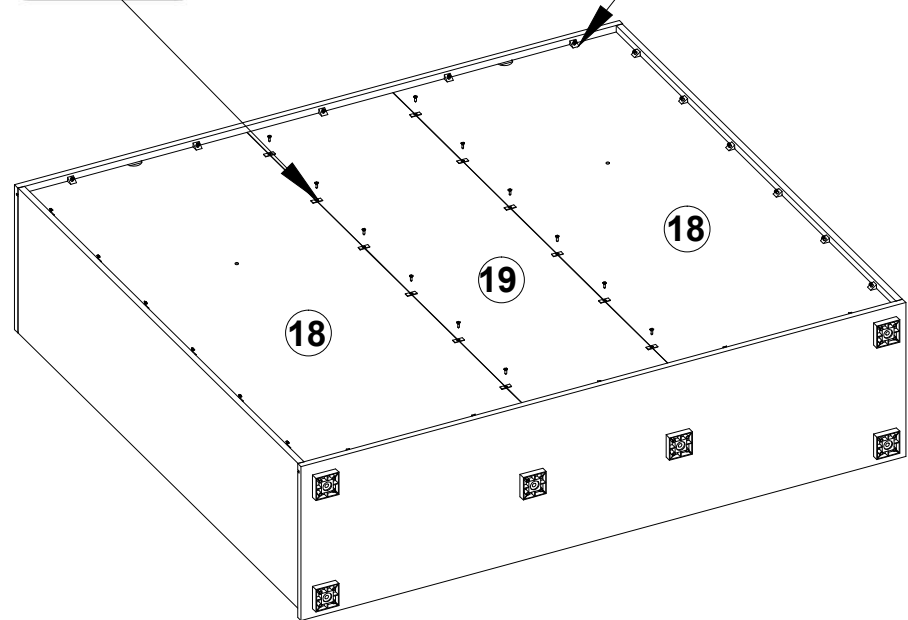
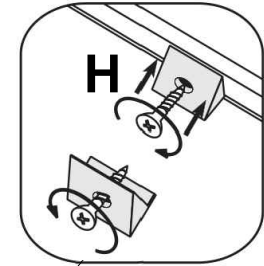
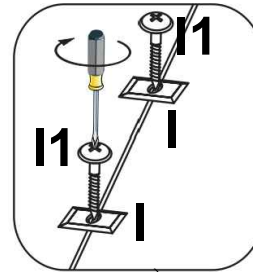

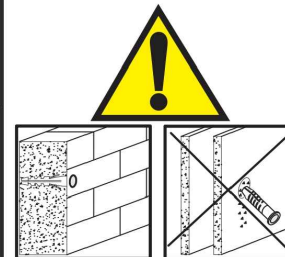
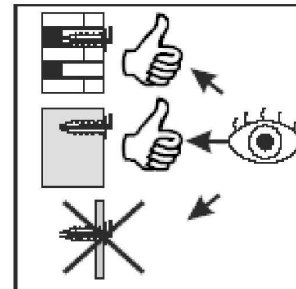
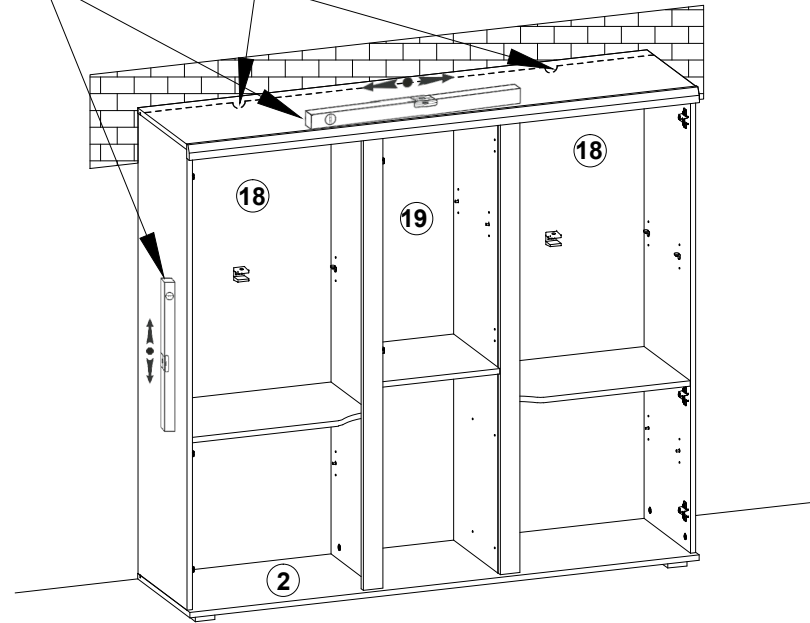
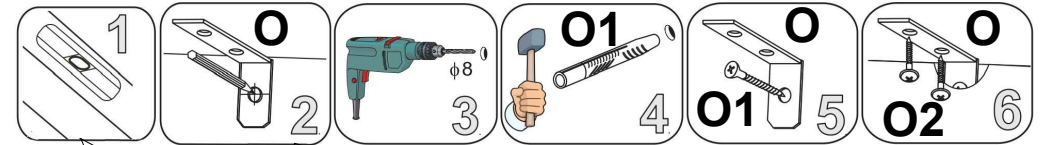
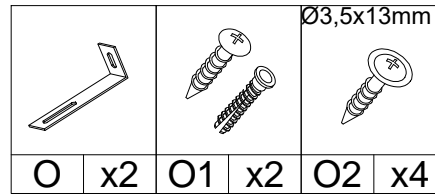
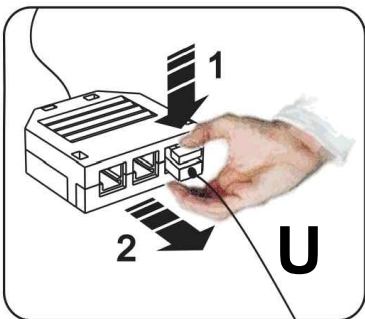
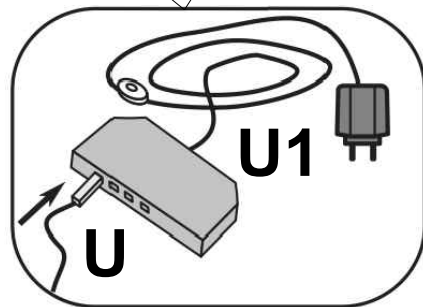
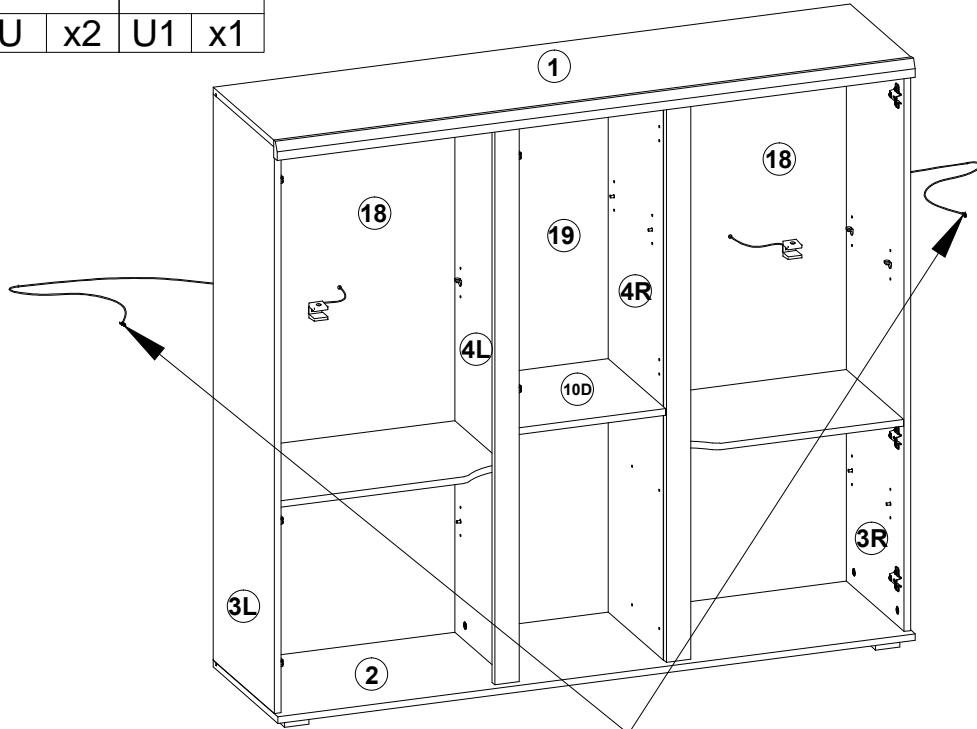
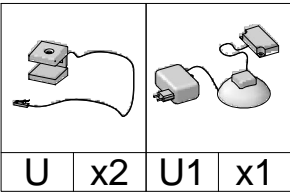

L-300mm		Ø6x11mm	
J	x2	J1	x8

Ø3,5x30mm			
F	x8	G1	x8

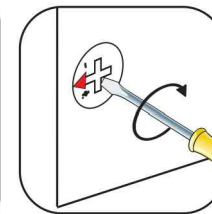
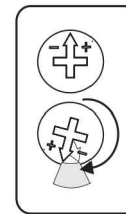
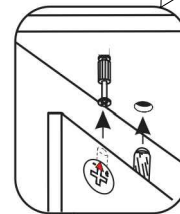
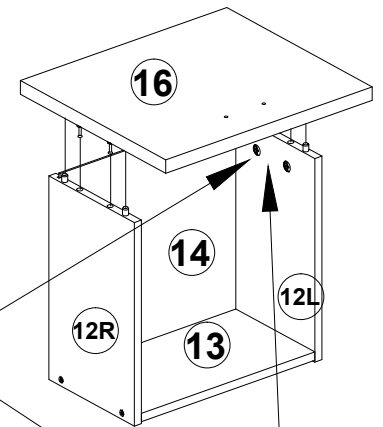
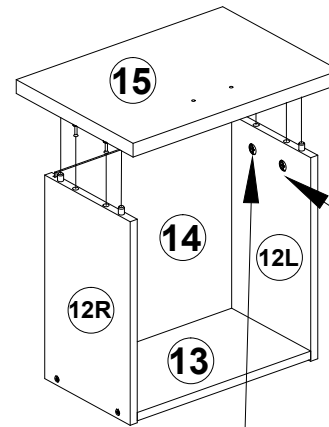
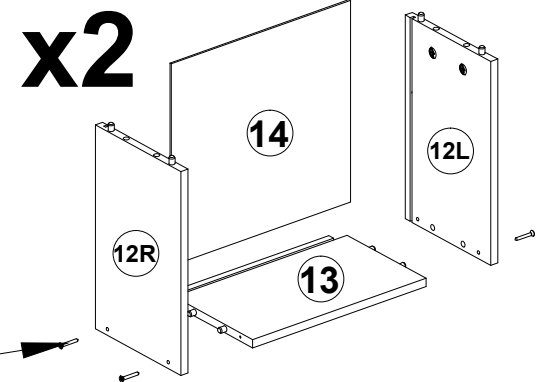
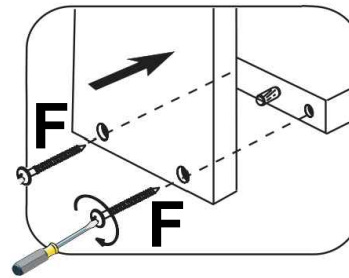
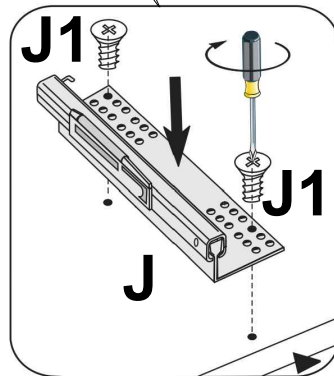
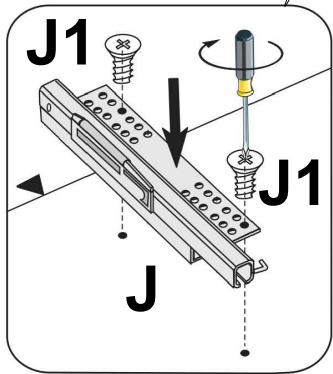
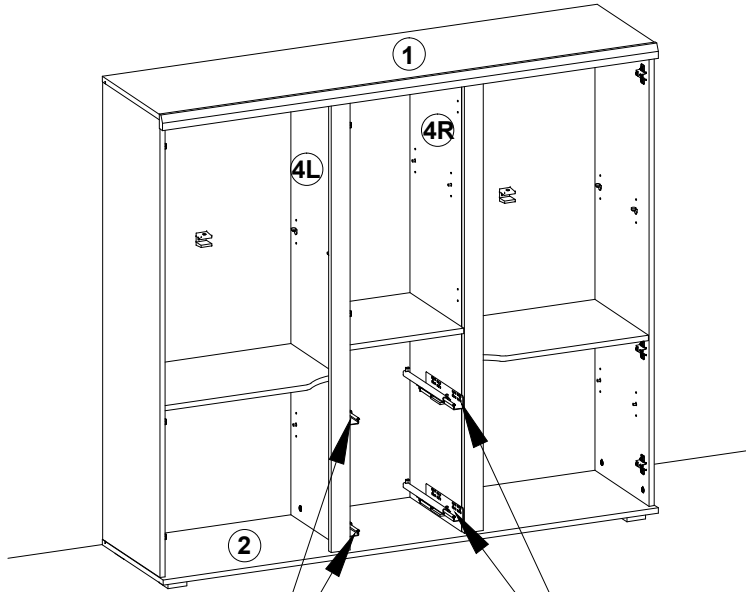

Ø3,5x13mm





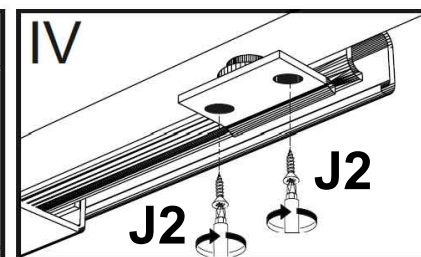
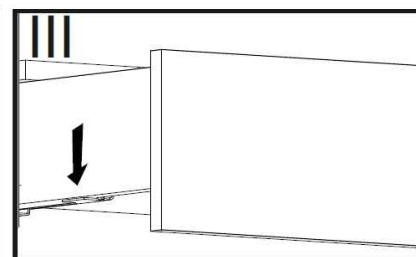
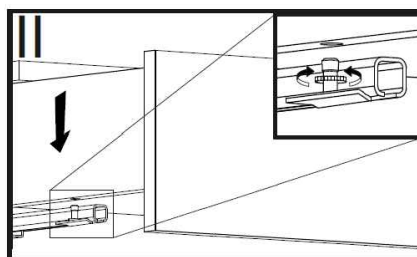
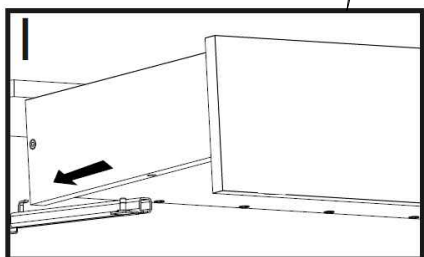
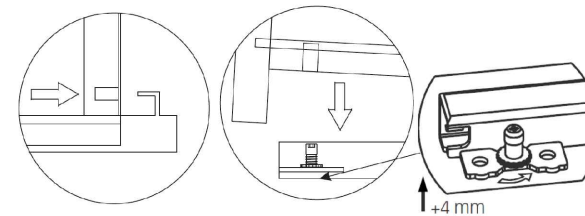
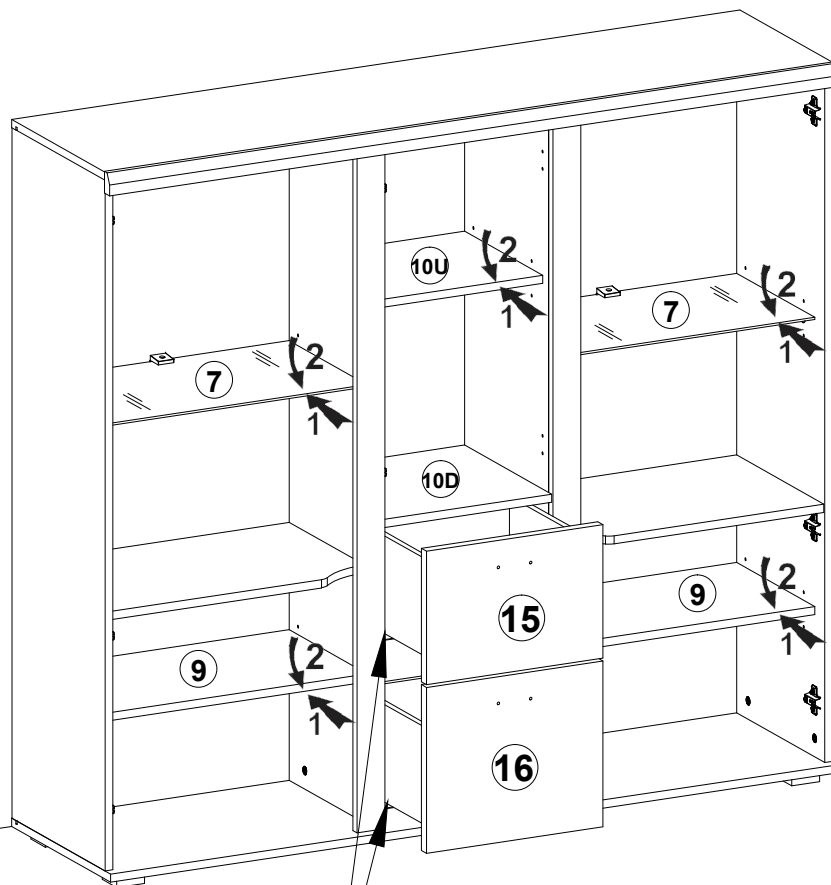

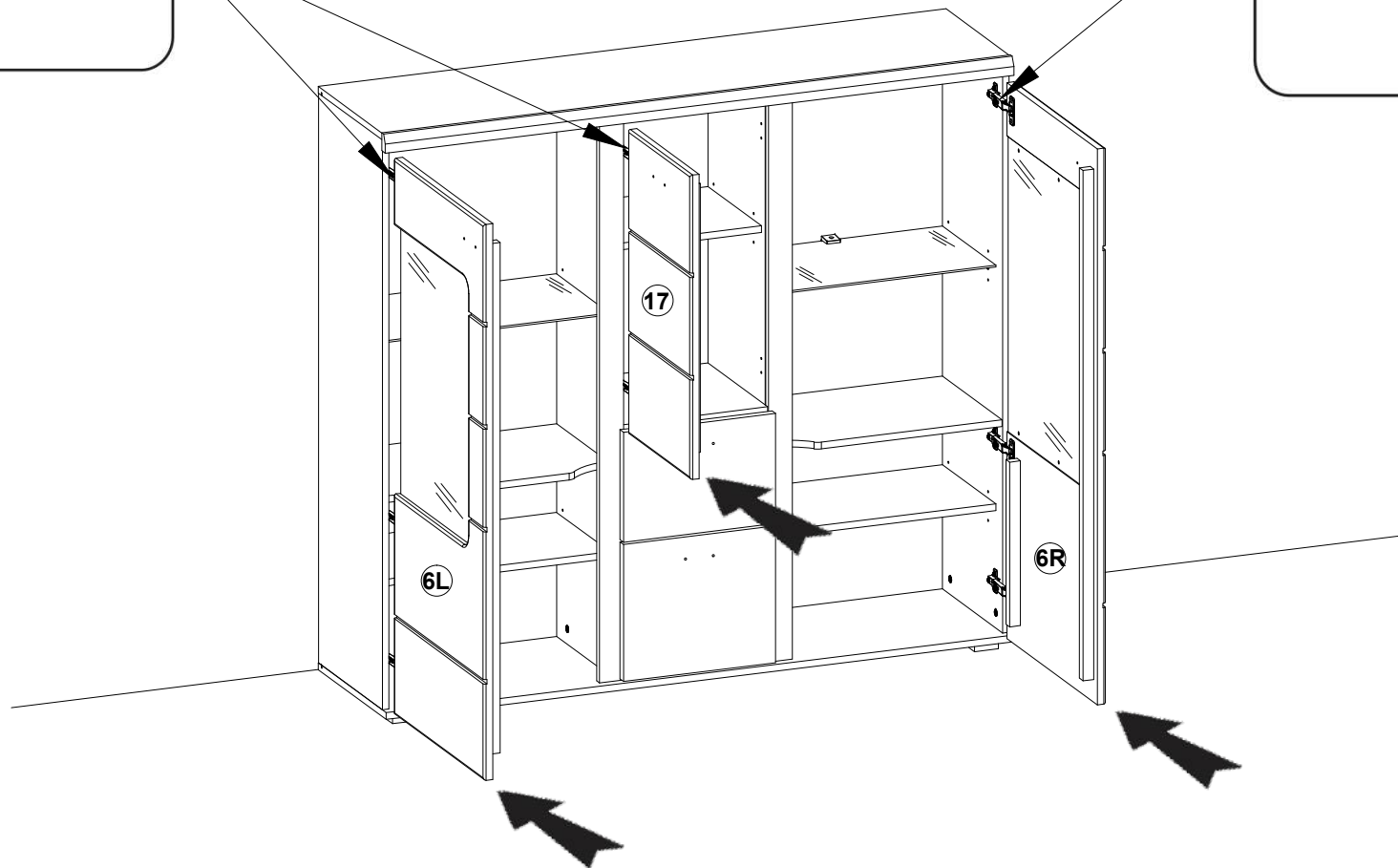
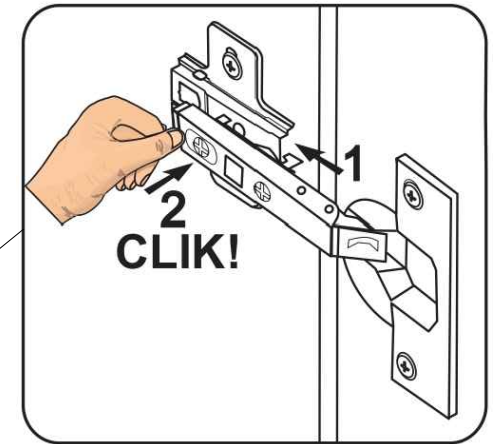
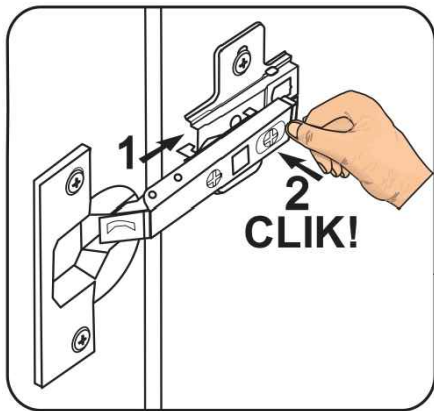
J2 x8



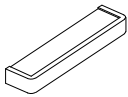

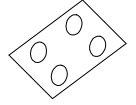
SONOS 1L-17HU-22

L-80mm	M4x25mm		
			
L x5	L1 x10	P x2	G x36

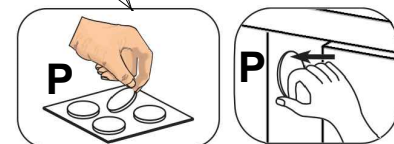
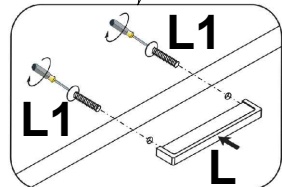
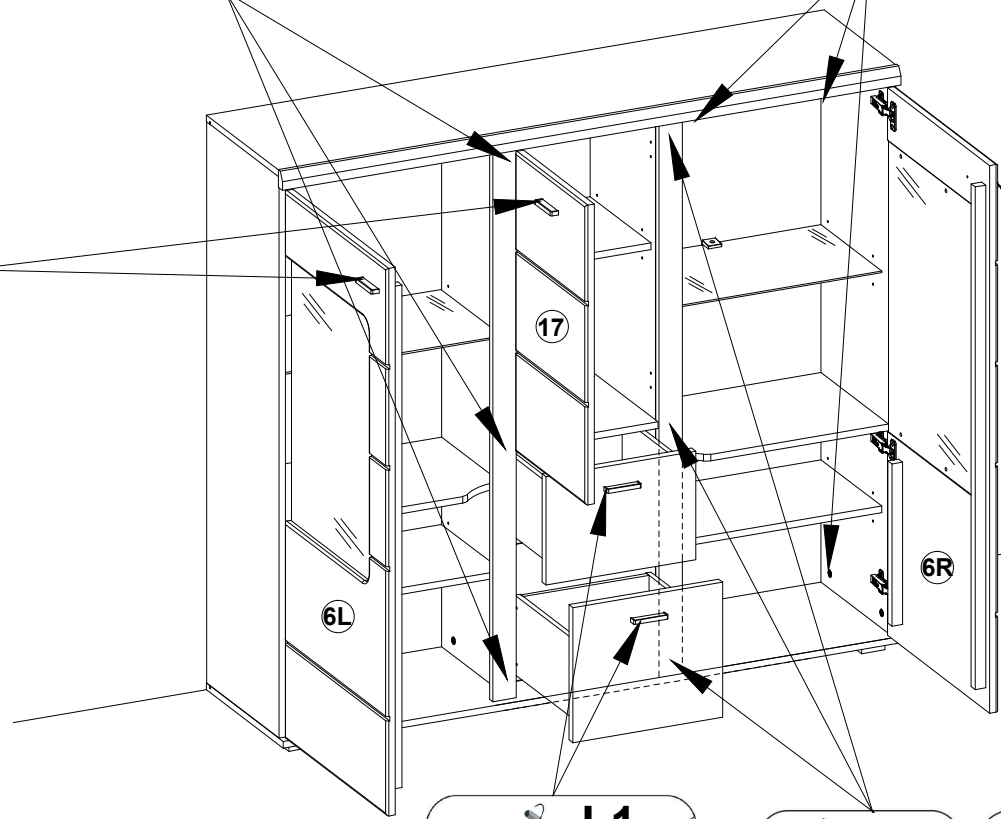
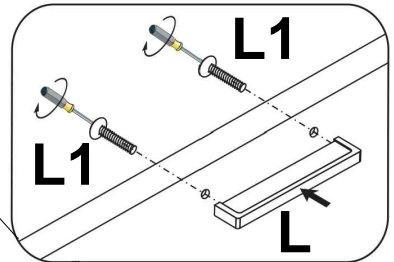
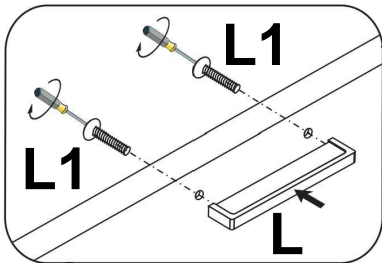
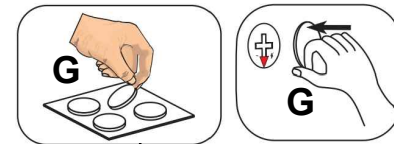
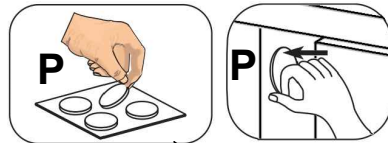

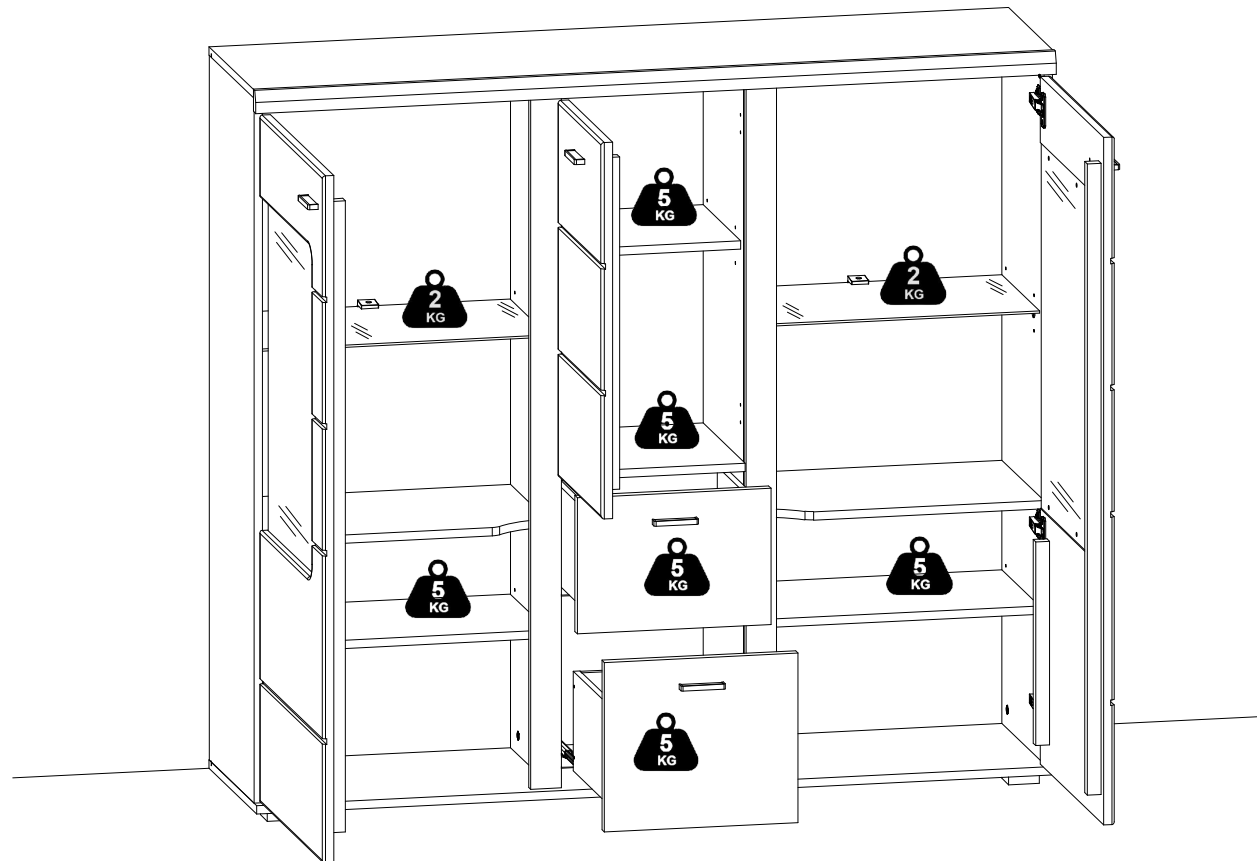
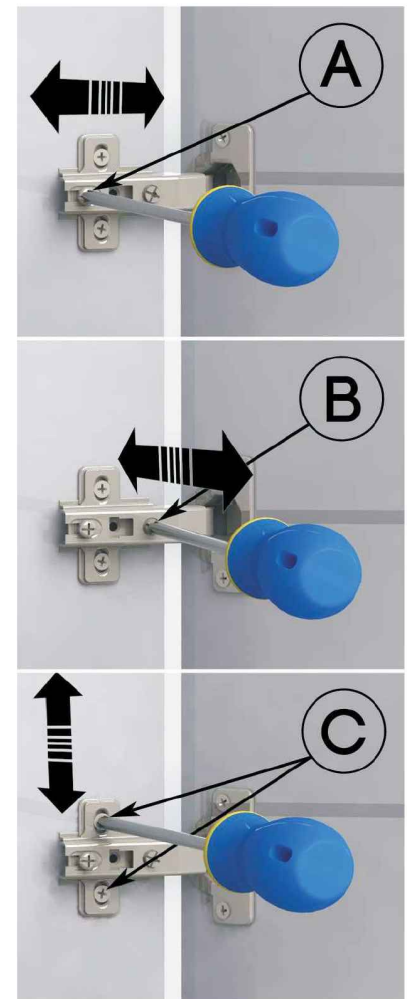
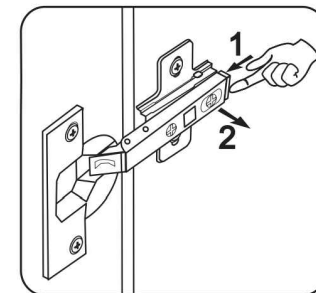
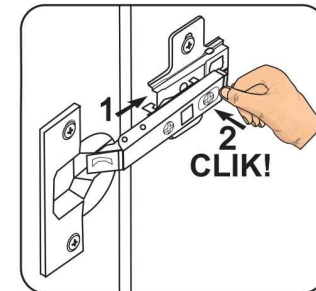

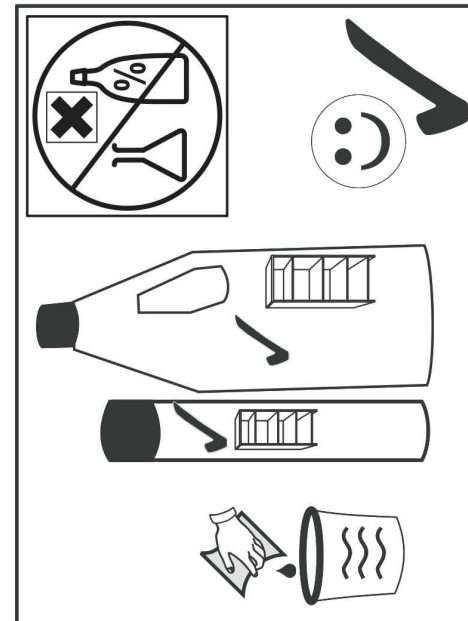
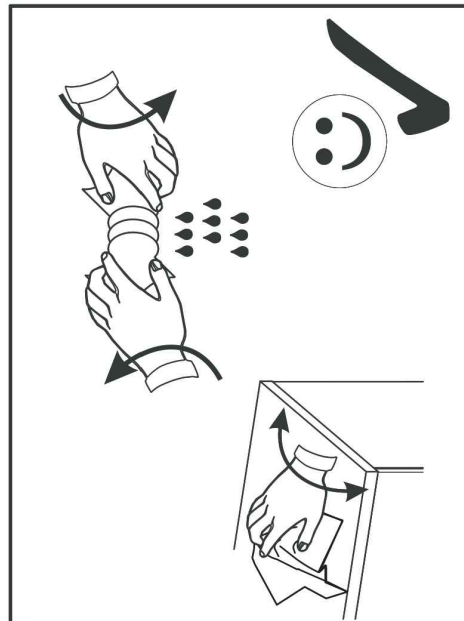
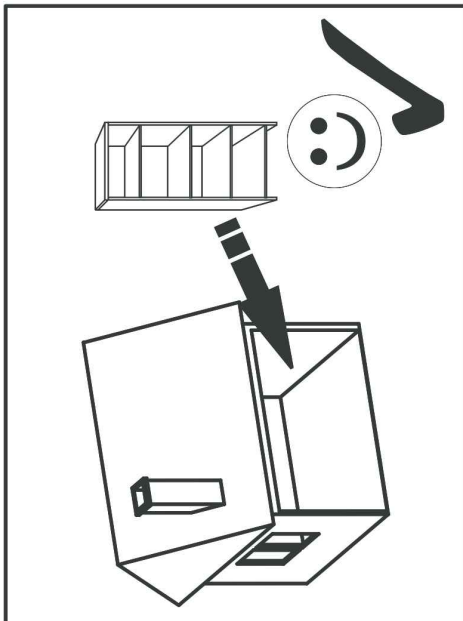
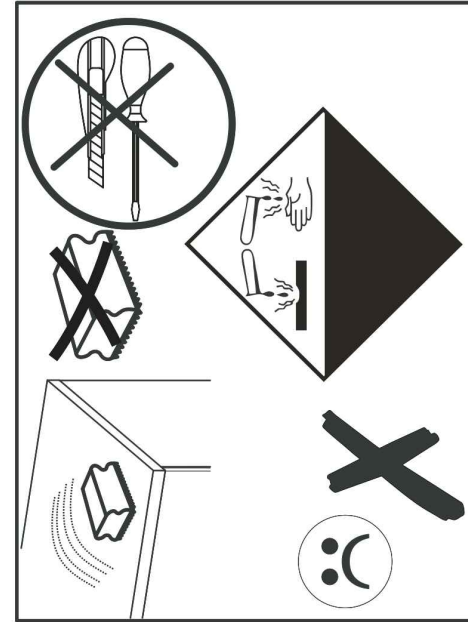
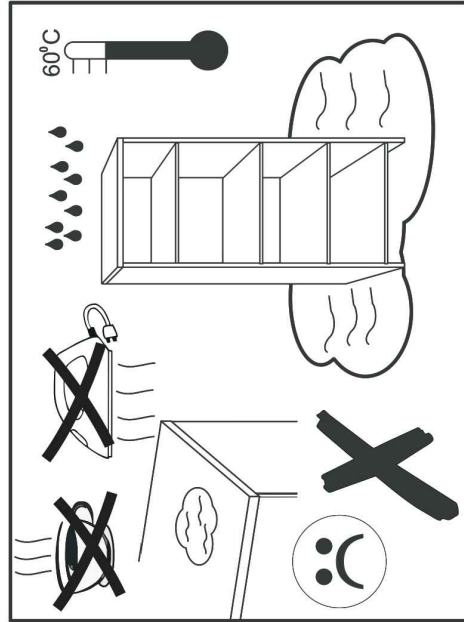
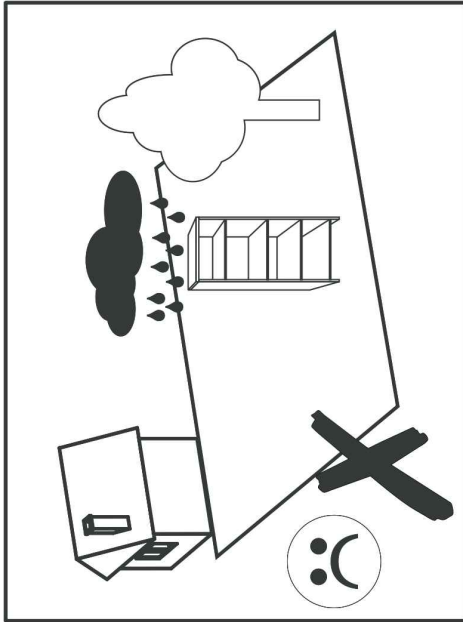
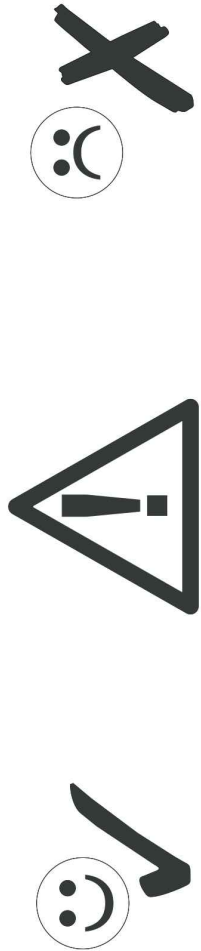

D CH AT LI LU**GB US****FR BE NC****NL****IT****SI****XS HR BA****HU****BG****CZ SK****SE****RO****ES**

Kleintelle und Verpackungsfolien bei der Möbelmontage von Kindern fernhalten!

Keep small parts and plastic film out of the reach of children!

Tenir les petites pièces et les films plastiques hors de la portée des enfants!

Houd de kleine onderdelen en de plastic folie uit de buurt van kinderen!

Tenere i componenti di piccole dimensioni e le pellicole di plastica fuori dalla portata dei bambini!

Majnih delov in embalažne folije pri montaži pohištva hranite izven dosega otrok!

Male dijelove i foliju za pakovanje priklonk montaže namještaja držite dalje od djece

Drehszerelés közben a kis alkatrészek és a csomagoló fóliák gyerekektől távol tartandók!

Prí montáži nábytku uchovávajte drobné dily a obalové fólie z dosahu detí!

Prí montáži nábytku uchovávajte drobné dily a obalové fólie z dosahu detí!

Vid möbelsmontering ska smådelar och förpackningsfolien hållas oåtkomliga för barn!

Tineți departe de copii piesele mici și folia de ambalat la montarea mobilier!

¡Durante el montaje, mantenga alejados de los niños las piezas pequeñas y el material plástico de embalaje!

D CH AT LI LU**GB US****FR BE NC****NL**

Möbelmontage muss auf ebenem Untergrund erfolgen. Bei Wandmontagen immer geeignetes Befestigungsmaterial verwenden.

Furniture must be assembled on a flat surface. For assembly to the wall only use suitable fixing materials.

Le meuble doit être monté sur une surface plane. Pour le montage mural, utilisez des accessoires de fixation adaptés au type de mur.

De meubels dienen op een vlakke ondergrond te worden gemonteerd. Voor wandmontage moeten geschikte bevestigingsmaterialen worden gebruikt.

Il montage dei mobili deve avvenire su un fondo piano. Per il montaggio si prega di utilizzare solo materiali adatti.

Pohištvo je treba montirati na ravni podlagi. Pri stenski montaži vedno uporabite pritrditveni material.

Namještal se mora montirati na ravnoj podlozi. Kod montaže na zid uvijek koristite prikladn materijal za pričvršćivanje.

A bútorcszerelésnél sikr felületeken kell végezni. Falra szereléshez mindig megfelelő rögzítanyagot kell használni.

Монтажът на мебелите да се извършва на равна основа. При стънен монтаж винаги да се използва подходящ крепежен материал.

Montáž nábytku provádějte na rovinném podkladu. Při montáži na stěnu používejte vždy vhodný přírůžkový materiál.

Montering av möbeln måste göras på jämnt underlag. Vid väggmontering ska lämpligt uppfästingsmaterial användas.

Montarea mobilier trebuie să se realizeze pe o pardoseală dreaptă. La montarea la perete utilizați întotdeauna material de fixare adecvat.

El montaje debe efectuarse sobre una superficie uniforme. En el montaje mural emplee siempre el material de fijación adecuado.

ES**D CH AT LI LU****GB US****FR BE NC****NL****IT****SI****XS HR BA****HU****BG**

Bitte beachten Sie die Montageanleitung. Halten Sie immer die angegebene Wattzahl ein. Verhindern Sie einen Hitzestau.

Please observe the assembly instructions. Do not exceed the max. given wattage. Ensure that the heat is not allowed to build up.

Veuillez respecter la notice de montage. Respectez impérativement le nombre des watts maximal. Veillez à éviter toute accumulation de chaleur.

Lees a.u.b. de montagehandleiding door. Houd u bezig aan het max. opgegeven wattage. Zorg ervoor dat geen hitteopwarming ontstaat.

Attenersi alle istruzioni di montaggio. Rispettarsi rigorosamente il numero di watt max. indicato. Assicurarsi che non si verifichi un accumulo di calore.

Proštevajte navodila za montažo. Vedno upoštevajte navedeno število vatov. Preprečite zastoj vročine.

Öbratite molimo Vas pozor na uputni za montažu. Uvijek se pridržavajte navedenog broja vat. Izbegavajte zastoj vrućine.

Yeğude figyelmbe a szerelési útmutatót. Mindig tartsa be a megadott wattszámot. Akadályozza meg a hőforródást.

Моля, вземете под внимание ръководството за монтаж. Спазвайте винаги посочените ватове. Избягвайте акумулиране на топлина.

Dodržujte prosim návod k montáži. Vždy dodržujte uvedenou hodnotu výkonu (watt). Zabráňte tak přehřívání.

Fóji montingsanvísningun. Fóji alltaf angivet wattal. Undvik att hetta uppstär.

Respectati instrucțiunile de montaj. Respectați întotdeauna numărul de wați impus. Evitați acumularea de căldură.

Le rogamos que tenga presente las instrucciones de montaje. Respete siempre el número indicado de vatios. Evite la acumulación de calor.

D CH AT LI LU**GB US****FR BE NC****NL****IT****SI****XS HR BA****HU****BG****CZ SK****SE****RO****ES**

Halten Sie die max. zulässigen Belastungswerte der Möbelteile ein. Details siehe Montageanleitung

Comply with the max. permissible loads. For details, please refer to the assembly instructions

Respectez les valeurs de charge max. admissibles des parties de meubles. Pour plus de détails, cf. la notice de

Houd de maximaal geoorloofde belastingswaarden van de meubeldelen aan. Voor details verwijzen wij naar de montagehandleiding

Rispettare la portata max. permessa degli elementi del mobile. Per dettagli si vedano le istruzioni di montaggio e si vada

Upoštevajte največje dovoljeno obremenitev delov pohištva. Podrobnosti najdete v navodilih za montažo in pa

Pridržavajte se maks. dovoljenih vrijednosti opterećenja elemenata namještaja. Detalje vidí u uputi za montažu

Tartsa be a bútorelemek max. megengedett terhelési értékeit. A részleteket lásd a szerelési útmutatóban

Spazivate maks. dopustimite strojnosti na natovaranje na mebelite. Za podrobnosti vijk ръководството за монтаж

Dodržujte max. pripusne hodnoy zatřžení nábytkových dílů. Podrobnosti viz návod k montáži

Fóji max. tilátlen belasting av möbeldelarna. Mer Information finns i monteringsanvisningen

Respectați valorile de solicitare max. admise pentru corpurile de mobilier. Pentru detalii consultați instrucțiunile de montaj

Respete los valores máximos de carga admisibles para las piezas de los muebles. Consulte los detalles en las instrucciones

D CH AT LI LU**GB US****FR BE NC****NL****IT****SI****XS HR BA****HU****BG****CZ SK****SE****RO****ES**

Zur Möbelreinigung ein mit Wasser befeuchtetes, fusselfreies Baumwolltuch verwenden. Geeignigte Flächen immer trockenreiben!

To clean the furniture only use a water dampened lint-free cotton cloth. Once cleaned, always wipe the surfaces dry.

Utilisez un chiffon en coton non pelucheux humidifié avec de l'eau pour nettoyer les meubles. Séchez systématiquement les surfaces

nettoyées en les frottant !

Gebruik een met water bevochtigde, pluïsvrije katoenen doek om de meubels te reinigen. Wrijf gereinigde oppervlakken altijd droog!

Per pulire il mobile utilizzare un panno di cotone linnudito d'acqua e che non perde pelucchi. Asciugare sempre le superfici che si sono

pulite!

Za čišćenje pohištva uporabljajte vlažno bombažno krpo, ki ne pušča vlaken. Očiščene površine vedno obrišite do suhlega!

Za čišćenje namještaja koristite sa vodom navlaženju pamučnu krpu koja ne ispušta vlakna. Očišćene površine uvijek obrišite suhom

krpomi!

Bútorisztáshoz vizzel benedvesített, nem szárazodó pamutkenőt használjon. A megtisztított felületeket mindig törölje szárazra!

За почистване на мебелите използвайте навлажнена с вода, неизгускаща влакна памучна кърпа. Почистените повърхности

виняги да се изтриват до сухо!

K čištění nábytku používejte bavlněný hadr neuvolňující vlákna, navlhčený ve vodě. Vyčištěné plochy vždy utřete do sucha!

För möbelsrengöring används en luddfri bomullsduk fuktad med vatten. Rengjorda ytor ska alltid torkas torra!

Pentru curățarea mobilier utilizai o lavetă din bumbac fără scame umezită cu apă. Suprafețele curățate se șterg întotdeauna până se

uscucă!

Emplee un paño de algodón humedecido con agua y libere de pelusa para la limpieza de los muebles. ¡Seque siempre las superficies

que ha limpiado!