

# Andrea

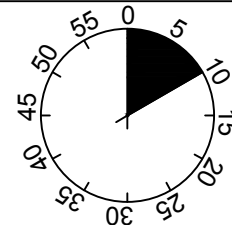
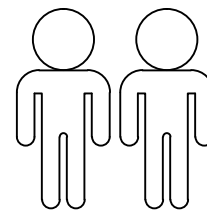
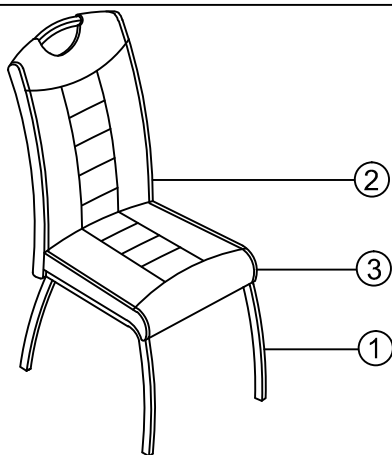

1

2

3

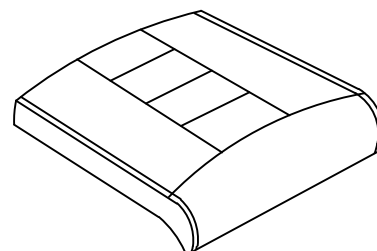
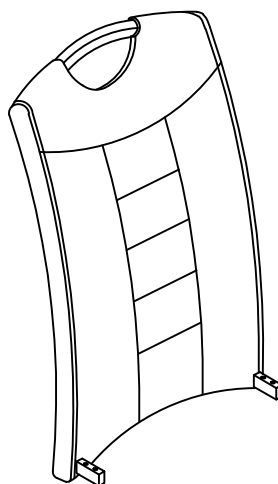
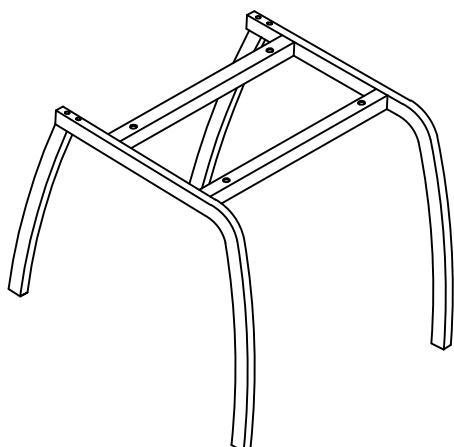



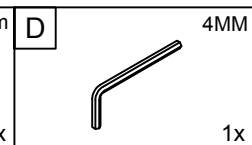
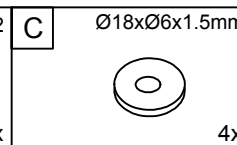
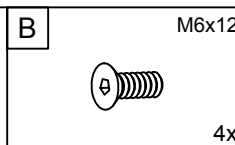
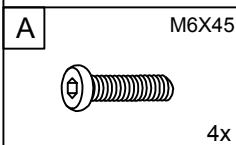

<b>1</b>	<b>1x</b>
<b>2</b>	<b>1x</b>
<b>3</b>	<b>1x</b>

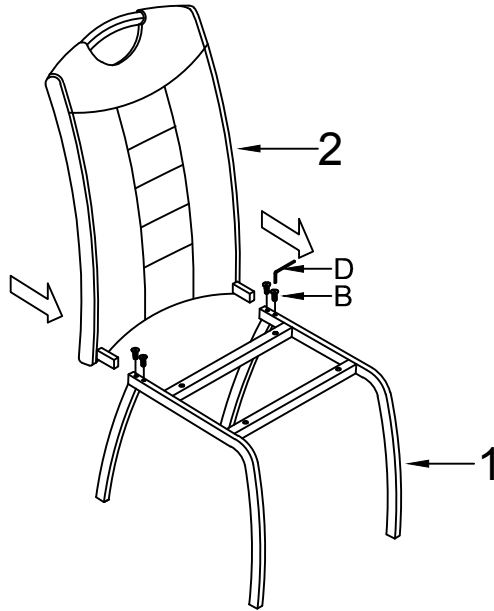

I.





1

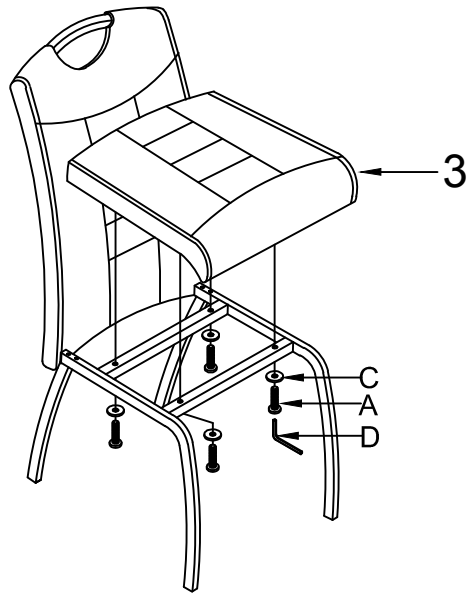

B	M6x12
	4x
D	4MM
	1x
	

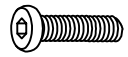
2



A	M6X45
	4x
C	Ø18xØ6x1.5mm
	4x
D	4MM
	1x
	

3

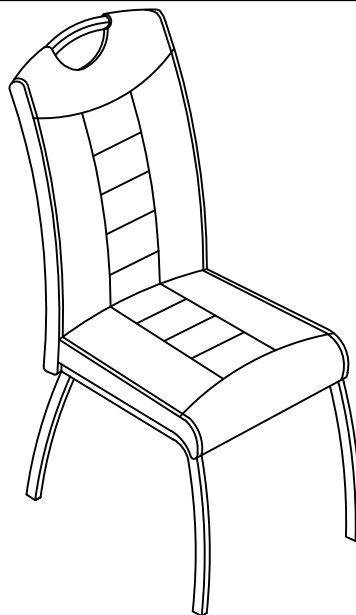

D	4MM
	1x
