

980417

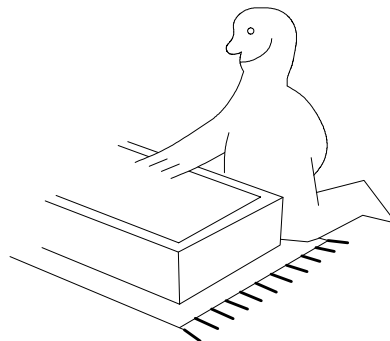
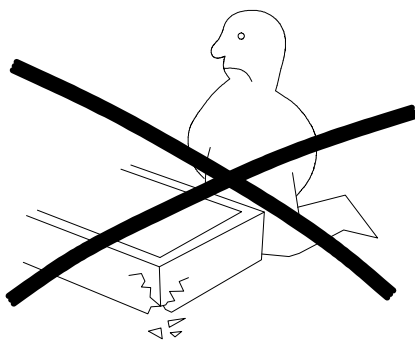
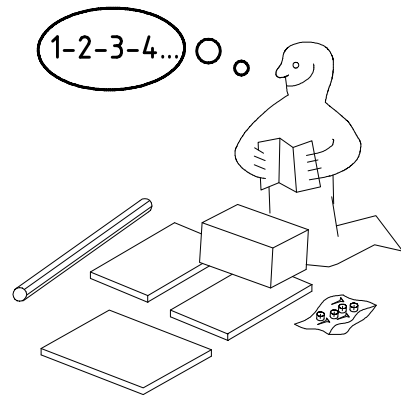
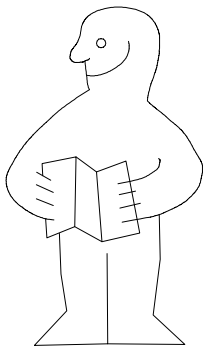
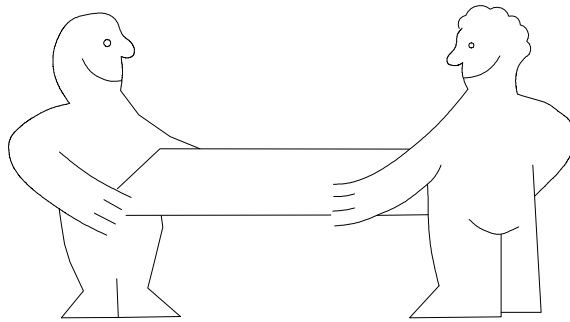
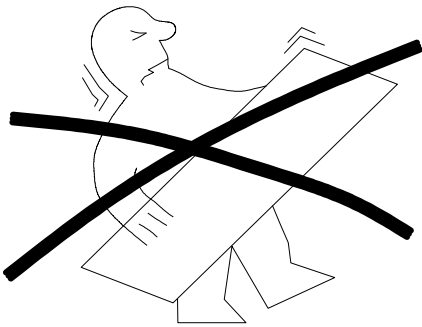
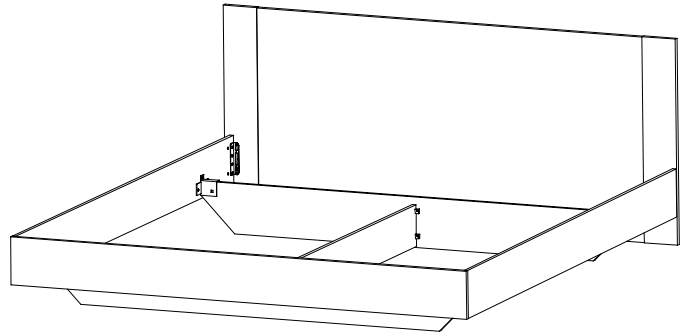
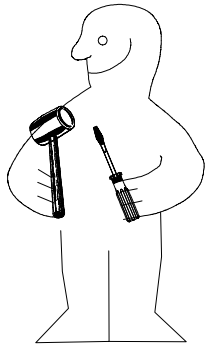

4 X 23 mm SP23 121117	9x
o3 111 353 6,0 x 12 mm	1x
G4 121 148	5x
u 111 066/074	4x

5,0 x 25 mm G5 121 156	8x
M6 x 11 mm T 112 055	12x
o5 111133	4x
us 129 407 $\phi 12$	4x

4,0 x 15 mm G23 121 110	20x
G6 121 150	8x

o 111 131 $\phi 10 \times 13$ mm	4x
H 111 112	5x

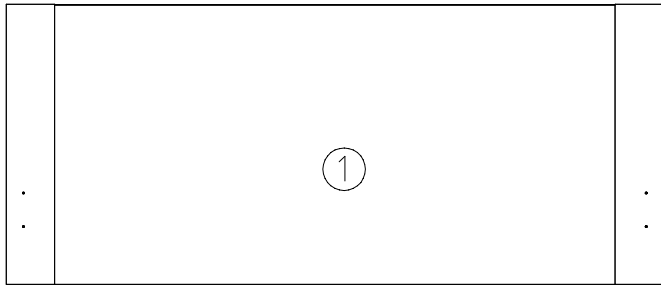
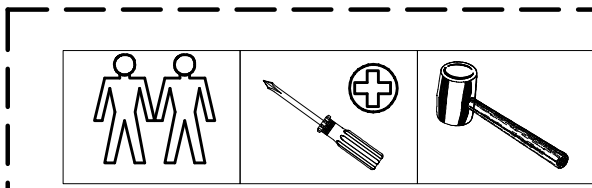
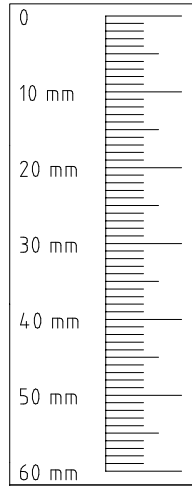

1484/ 1684/ 1884 x 800x 15

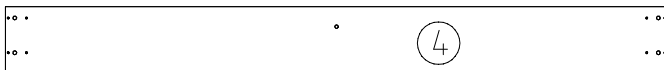

1436/ 1636/ 1836 x 180x 18



1400/ 1600/ 1800 x 200x 15



2000 x 180x 18



1430 x 160x 15

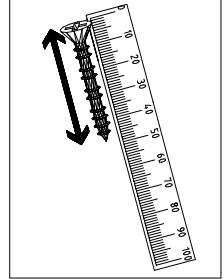

1.

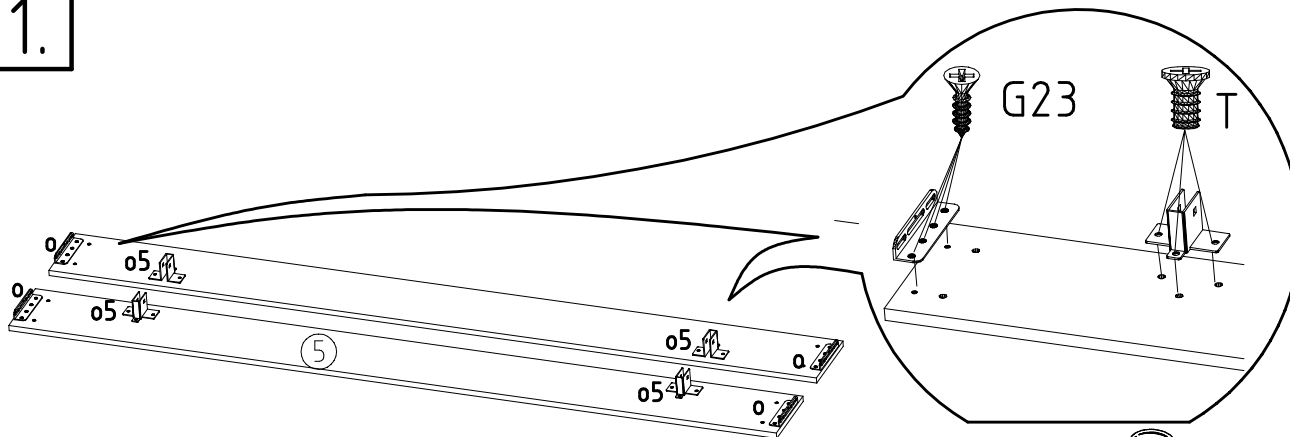

4,0 x 15 mm G23 121 110
o 111 131 $\phi 10 \times 13$ mm
T M6 x 11 mm 112 055
o5 111133

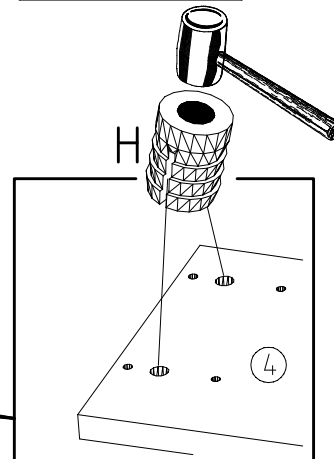
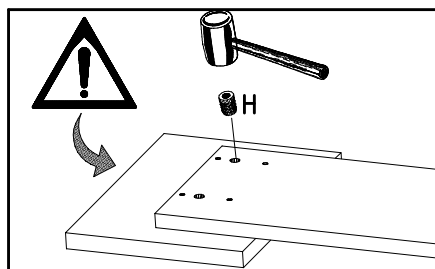

H $\phi 10 \times 13$ mm 111 112

980417

17.11.09 / 06.08.10

08 10

2/4

2.

5,0 x 25 mm

G5

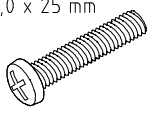

121 156

G6

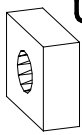

121 150

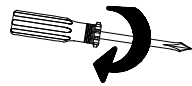

G5

5

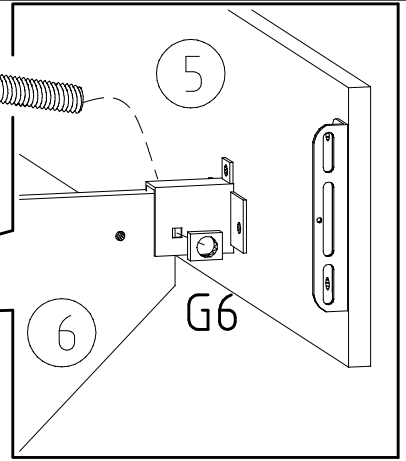

6

G6

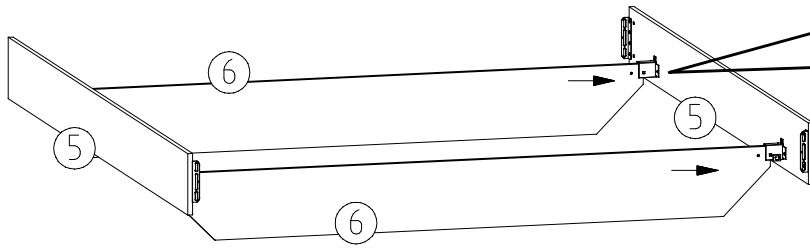

3.

G5

G23

G5

US

G6

US

G6

1

4

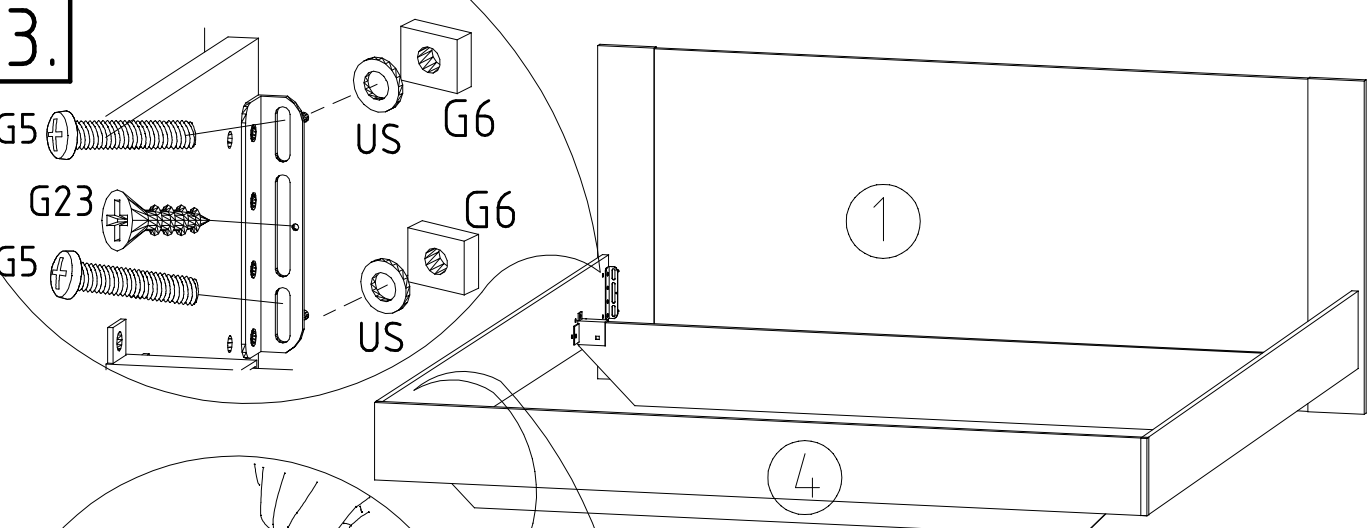

G4

G23

G4

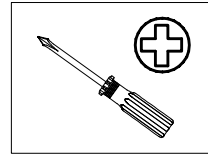
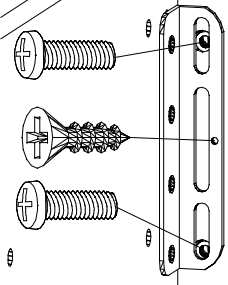

5,0 x 25 mm

G5

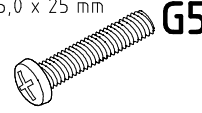

121 156

6,0 x 12 mm

G4

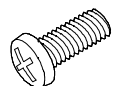

121 148

US

4,0 x 15 mm

G23



129 407

ø12

121 110



4.

4 X 23 mm

SP23

121117



U

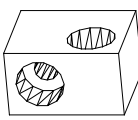

111 066/074

7

U



U

U

7

U

U

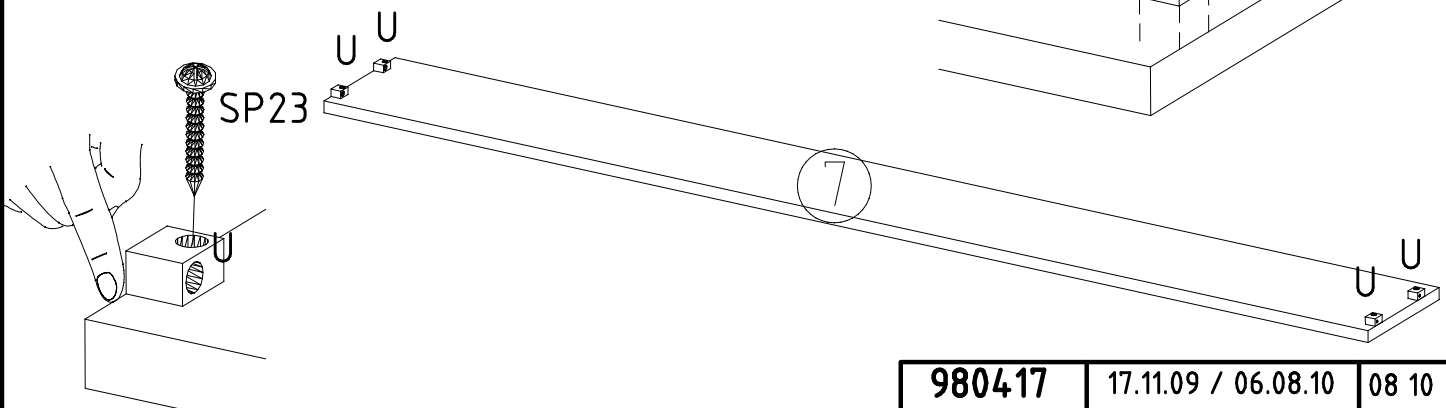

980417

17.11.09 / 06.08.10

08 10

3/4

5.

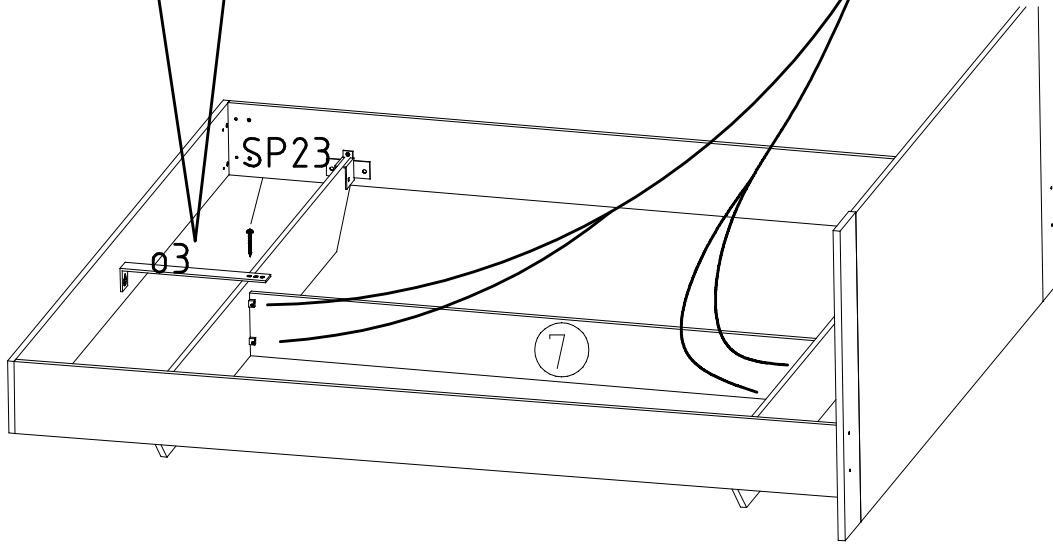
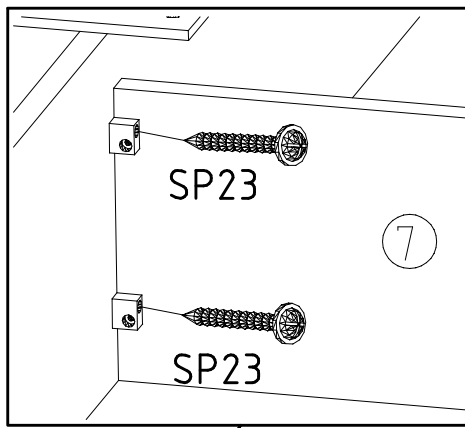
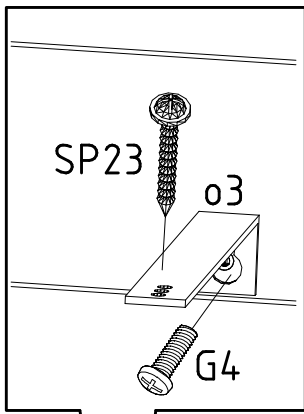

6,0 x 12 mm **G4**

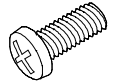

121 148

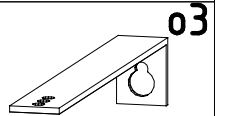

111 353

4 X 23 mm **SP23**

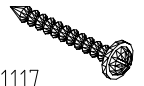

121117

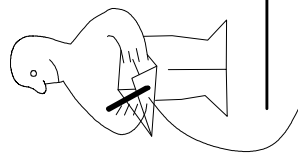
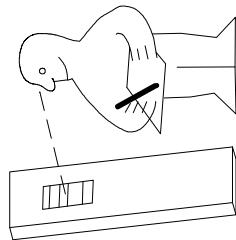
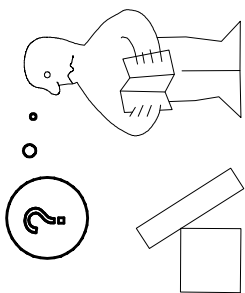
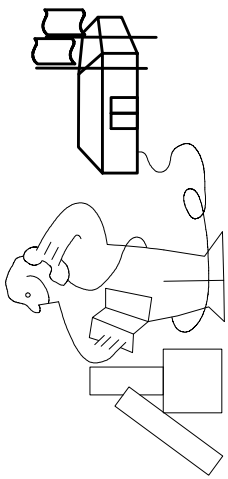
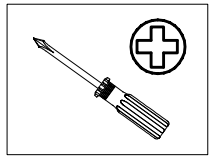

Modell/Model/Modèle

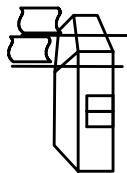

Anzahl
Aantal
A lot of
Quantité

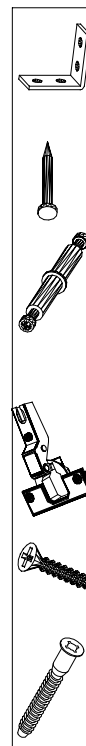

(121 370)	(G 1)	(4x)					

980417

17.11.09 / 06.08.10

08 10

4/4

Änderungen die dem technischen Fortschritt geschuldet sind, behalten wir uns vor !