

Amy

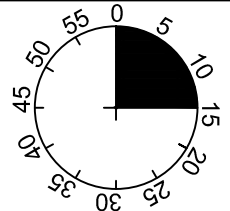
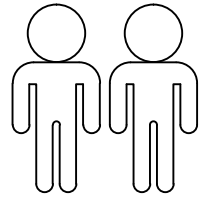
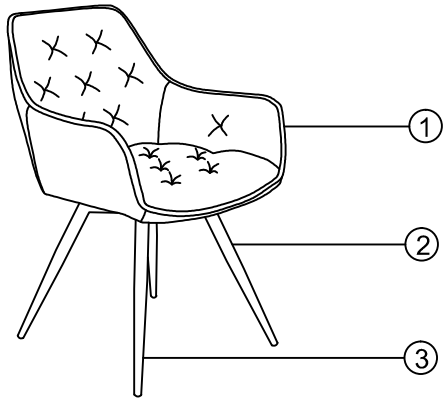

1

2

3

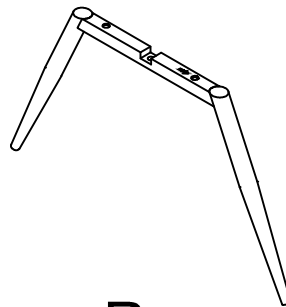
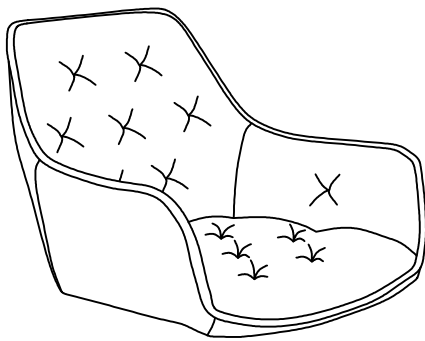



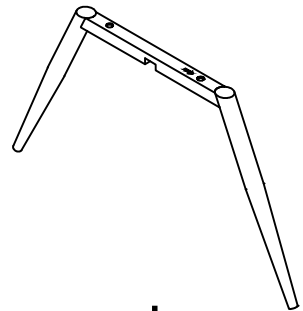

R

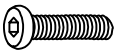

L



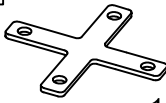

1	1 x
2	1 x
3	1 x

A	M6X40	B	M6x13	C	Ø18xØ6x1.5	D	4MM	E	T2.0x90x90
									
	4x		4x		4x		1x		1x

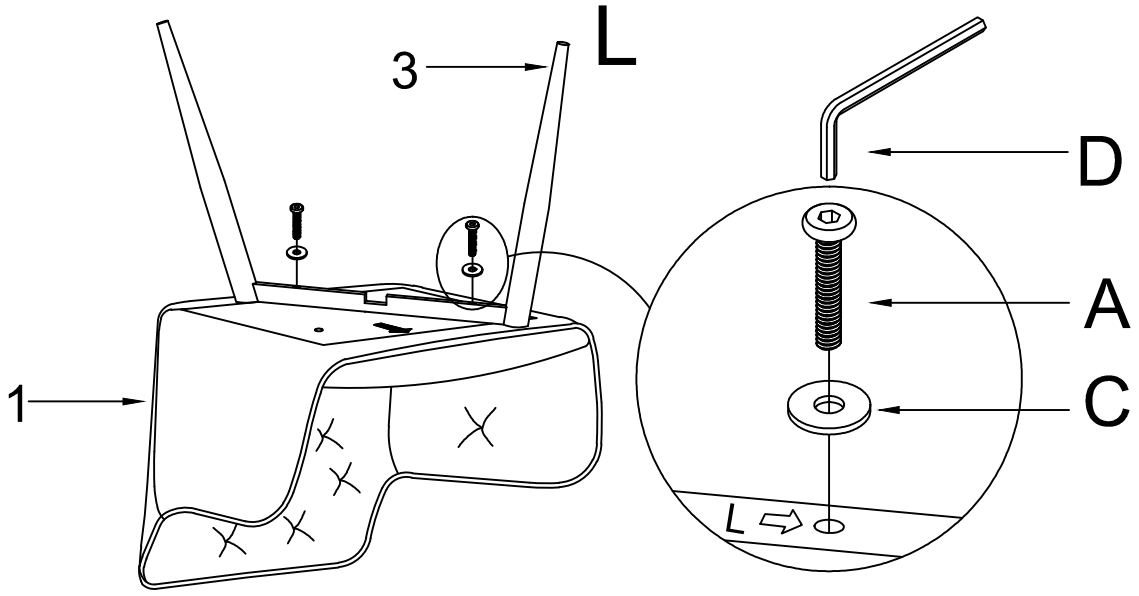
I.

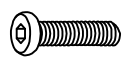

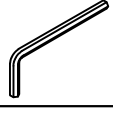

1

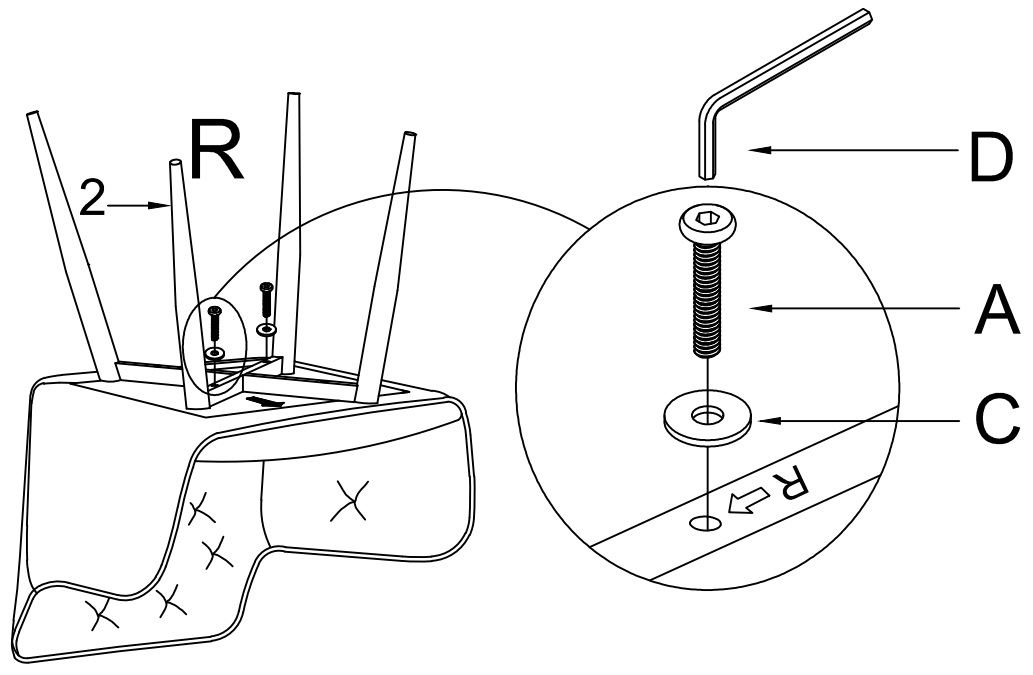

A	M6x40
	2x
C	Ø18xØ6x1.5
	2x
D	4MM
	1x
	

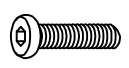
2

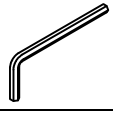



A	M6x40
	2x
C	Ø18xØ6x1.5
	2x
D	4MM
	1x
	

II.

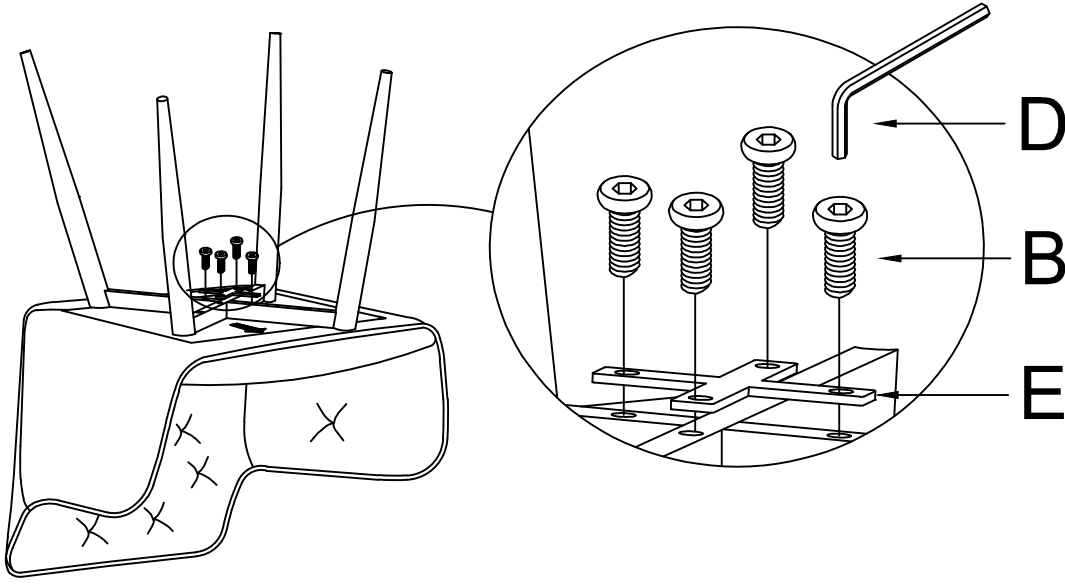

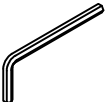
3

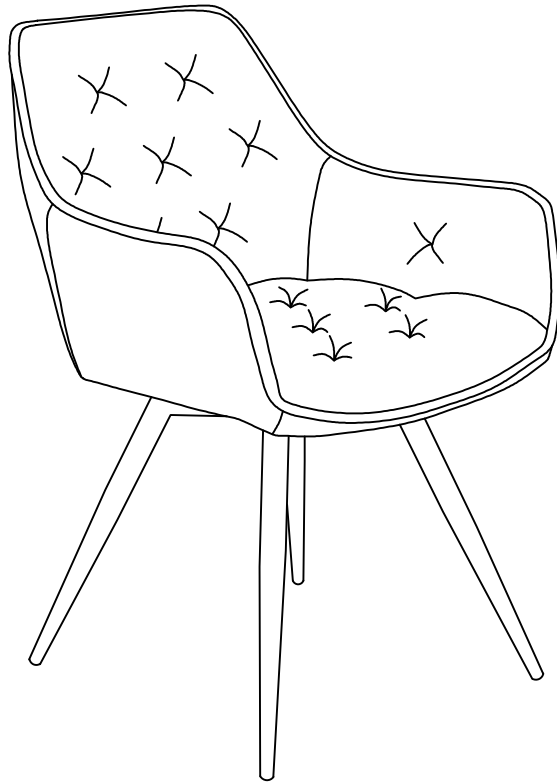

- B** M6x13
 4x
- D** 4MM
 1x
- E** T2.0x90x90
 1x
-  75%

4

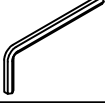

- D** 4MM
 1x
-  100%

