

System Diamond 140/160/180/200 x 200



D Montageanleitung

GB Assembly instructions

NL Handleiding voor de montage

PL Instrukcja montażu

TR Montaj talimatı

RU Инструкция по монтажу

RO Instrucțiunile de instalare

I Istruzioni per l'installazione

F Instructions d'installation

SK Návod na inštaláciu

CZ Návod k instalaci

H Telepítési utasítások



12345678

280120160

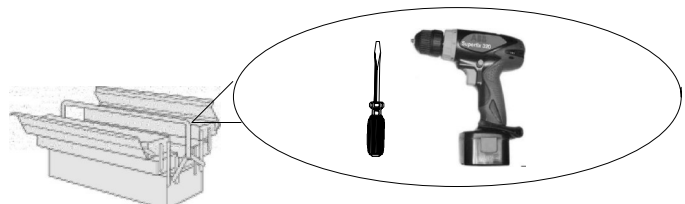
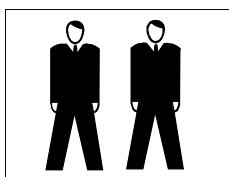

Service • Dienstverlening • Serwis • Servis • Сервисная служба

Name • Naam • Nazwa • Isim • Название

System Diamond

Nr. • No. • Номер

13245678

Typ • Type • Тип • Тип

140/160/180/200 x200

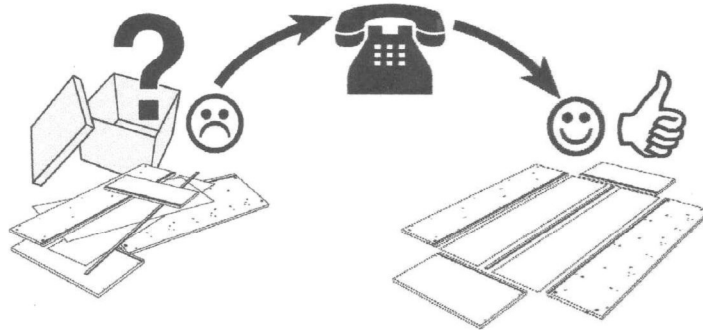
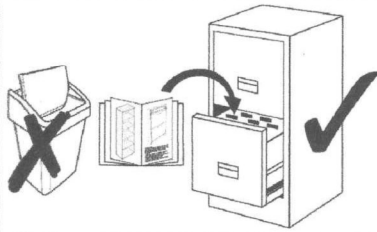

A	16X	B	8X	C	KT 2	8X	D	1X	E	8X
Linsenschraube M6x20		Metall- verbinder		Holzschraube 5x50			Bettklemme		Fuß 10cm	
F	4X	G	2X							
Schraube M8x20										

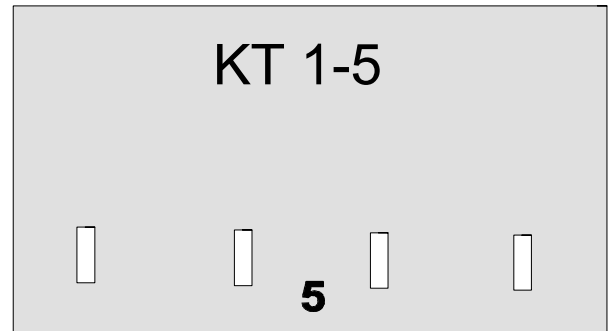

**KT 2
+6L, +6R**

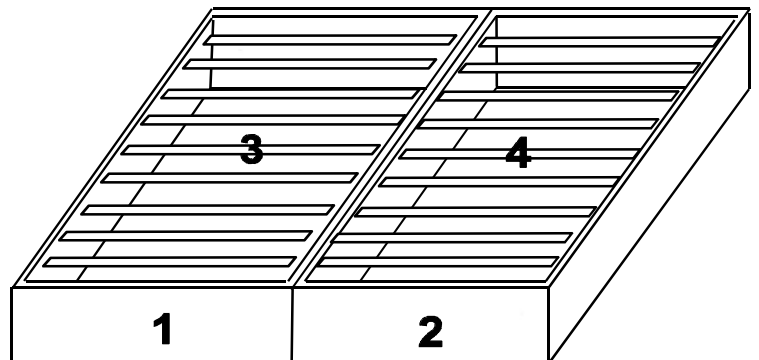
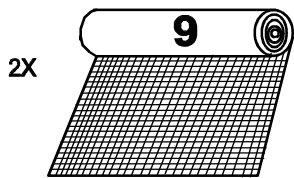
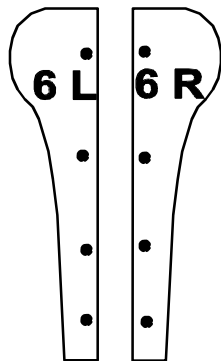

2X 7

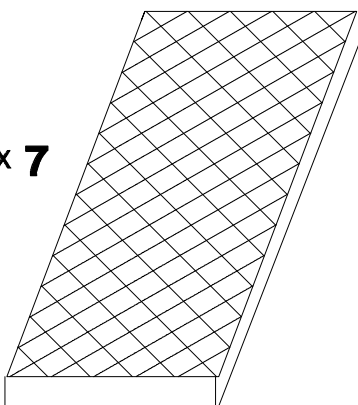

oder
or
ou
of
o
veja
lub
nebo
alebo
vagy
или
sau

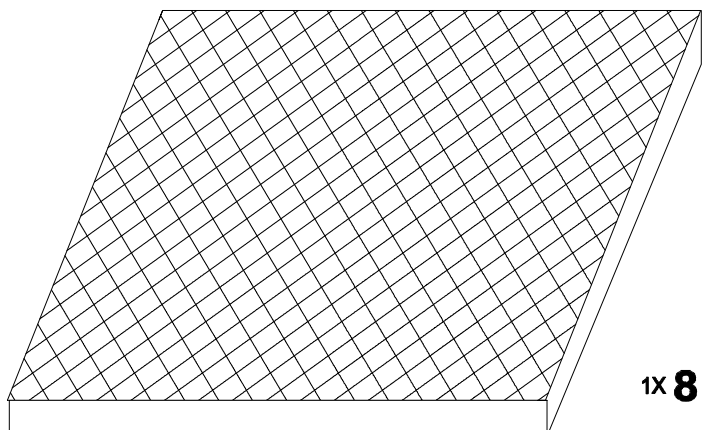

1X 8

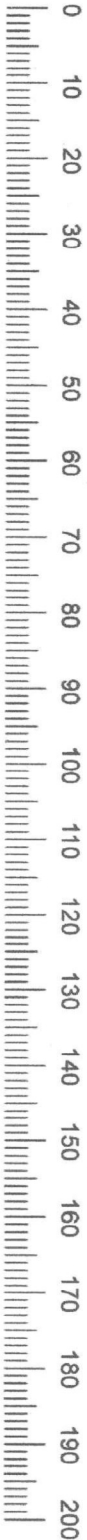

1.

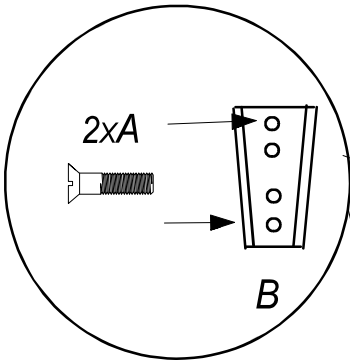
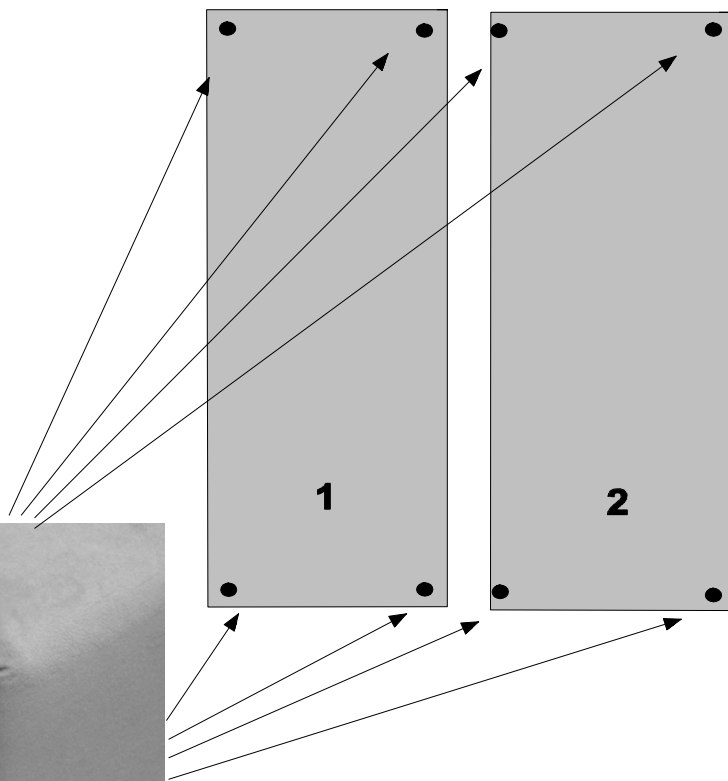
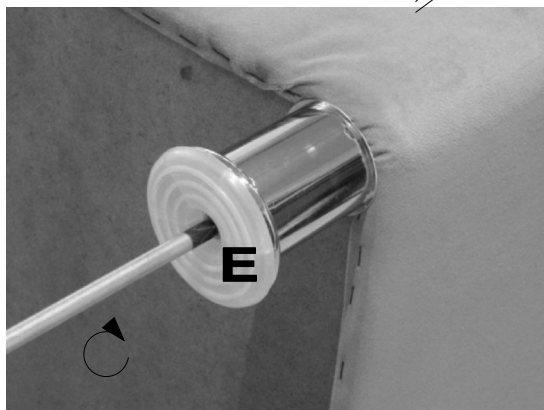

2.

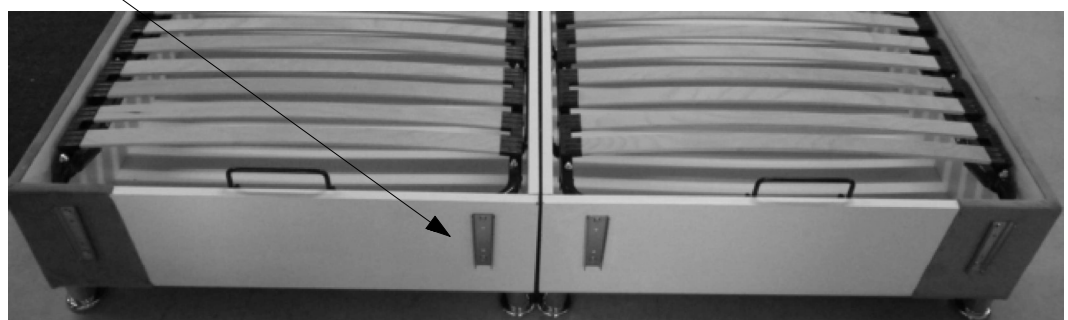
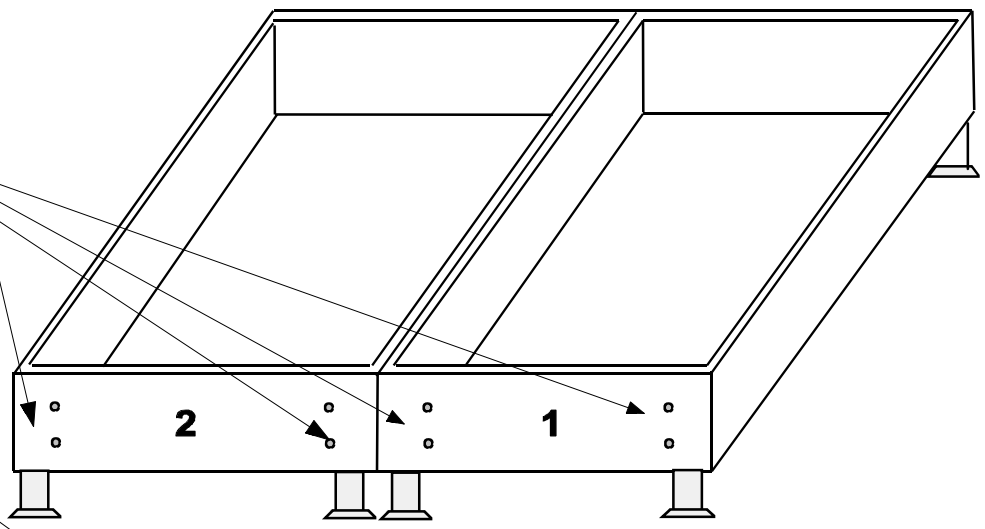

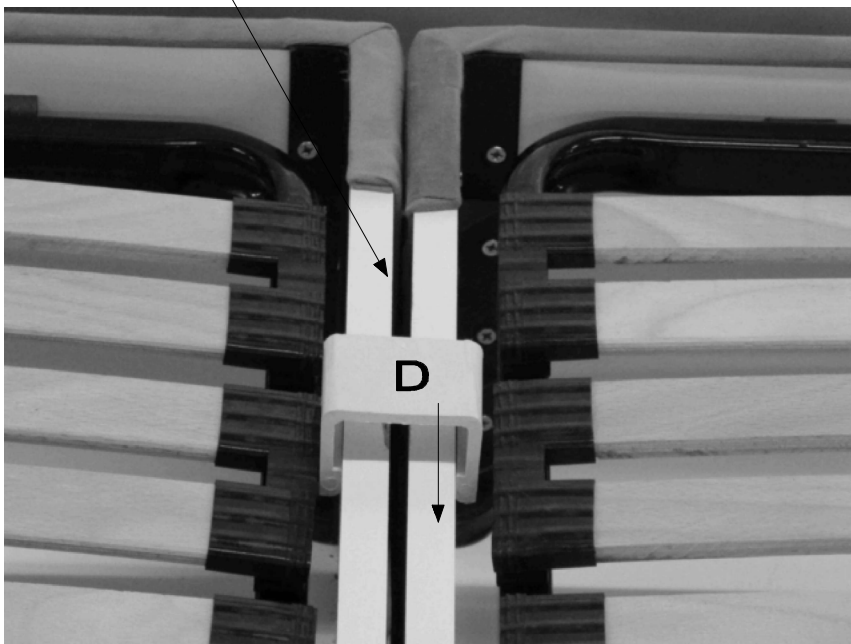
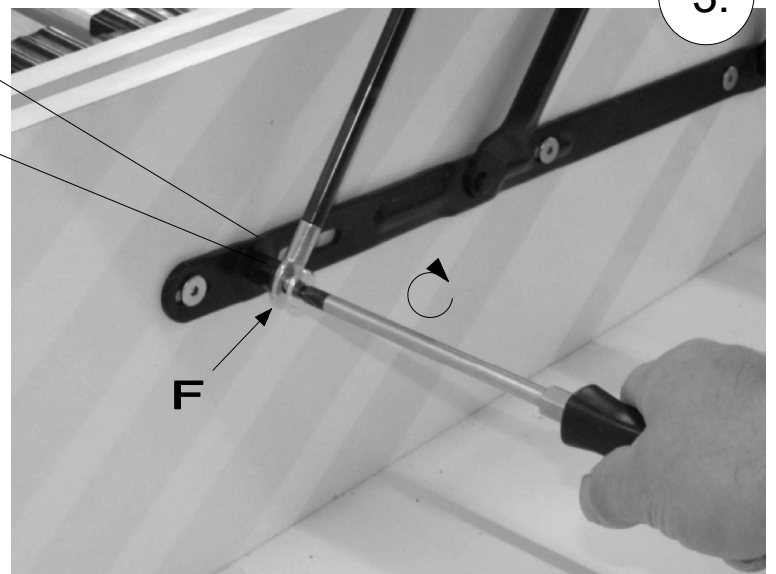

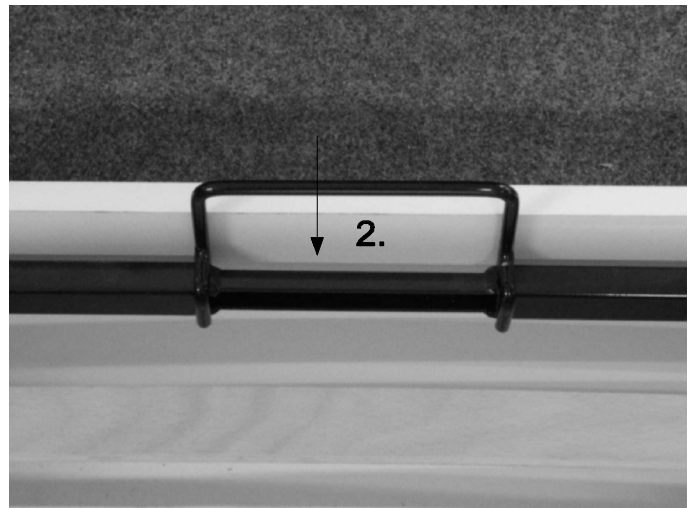
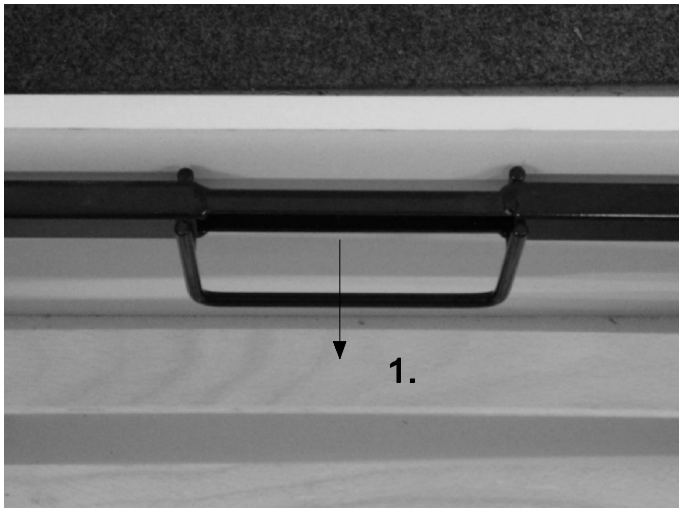
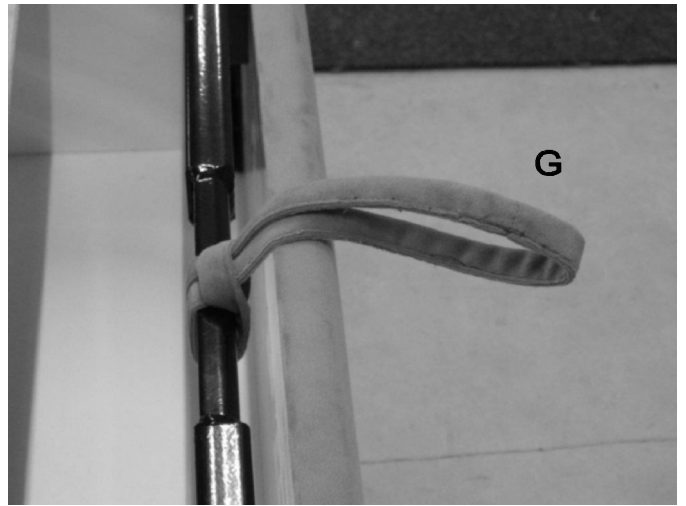
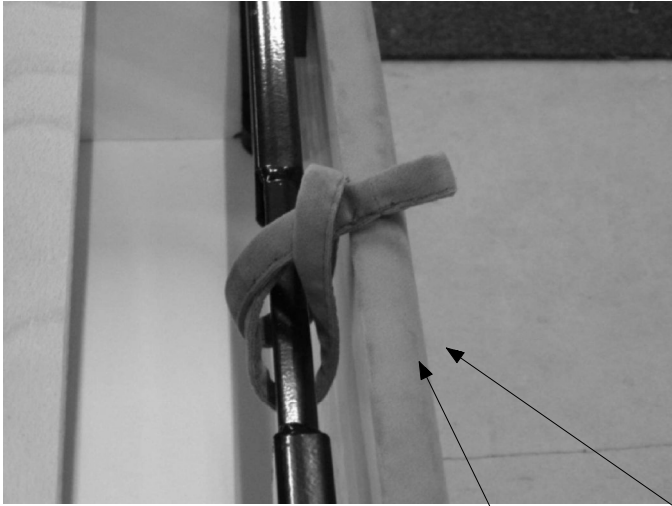

7.

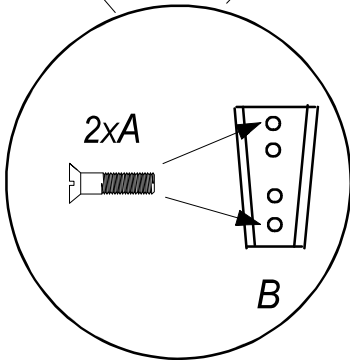
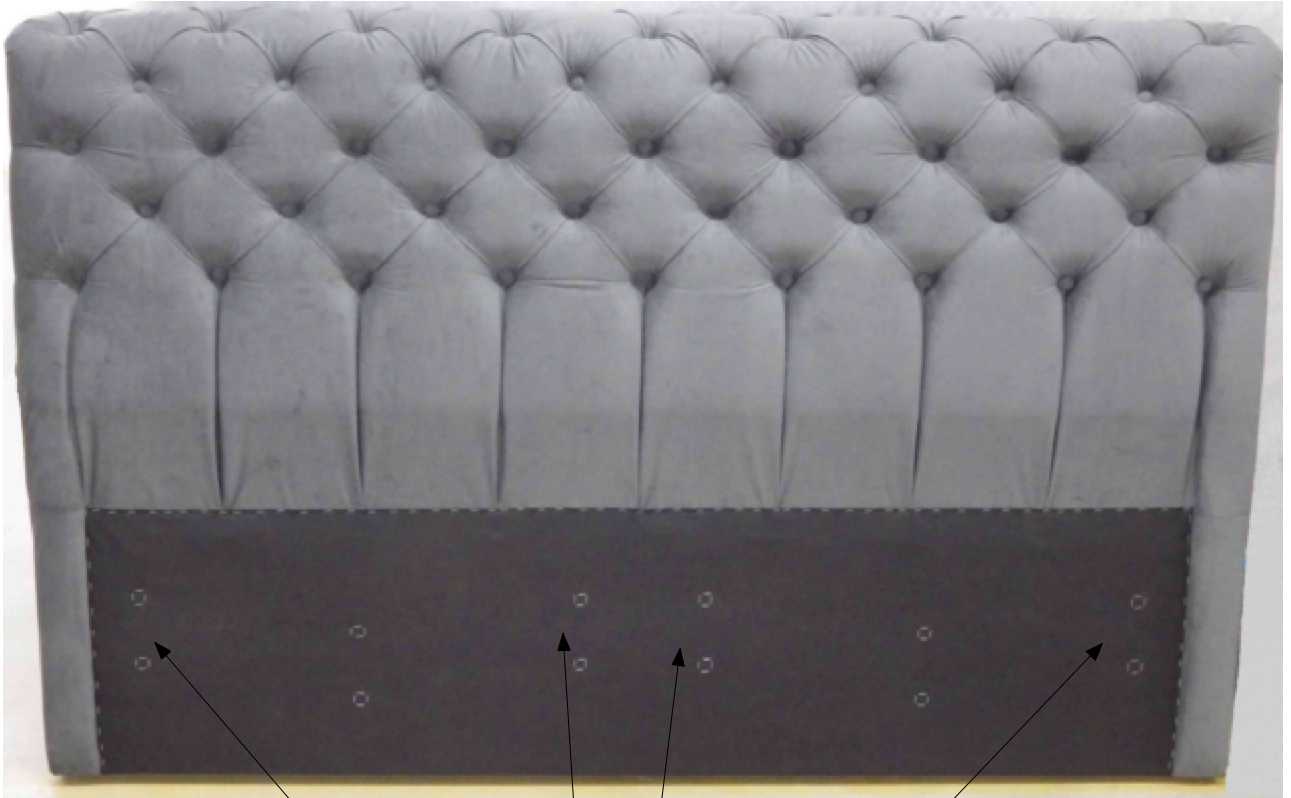

8.

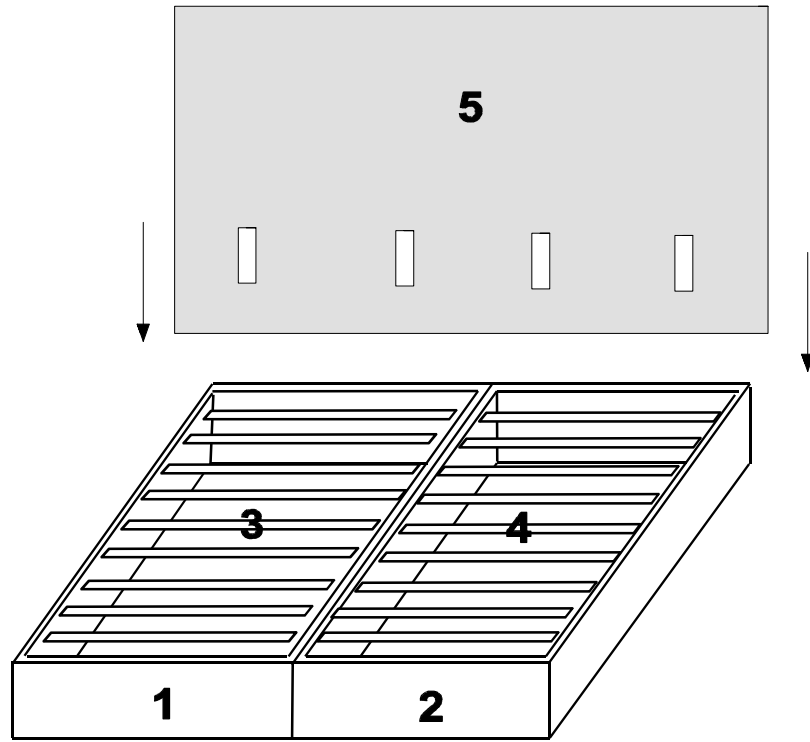

8.1

KT 2

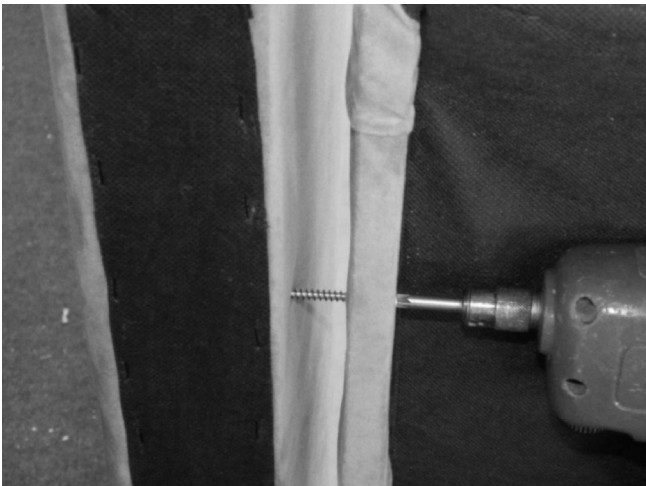
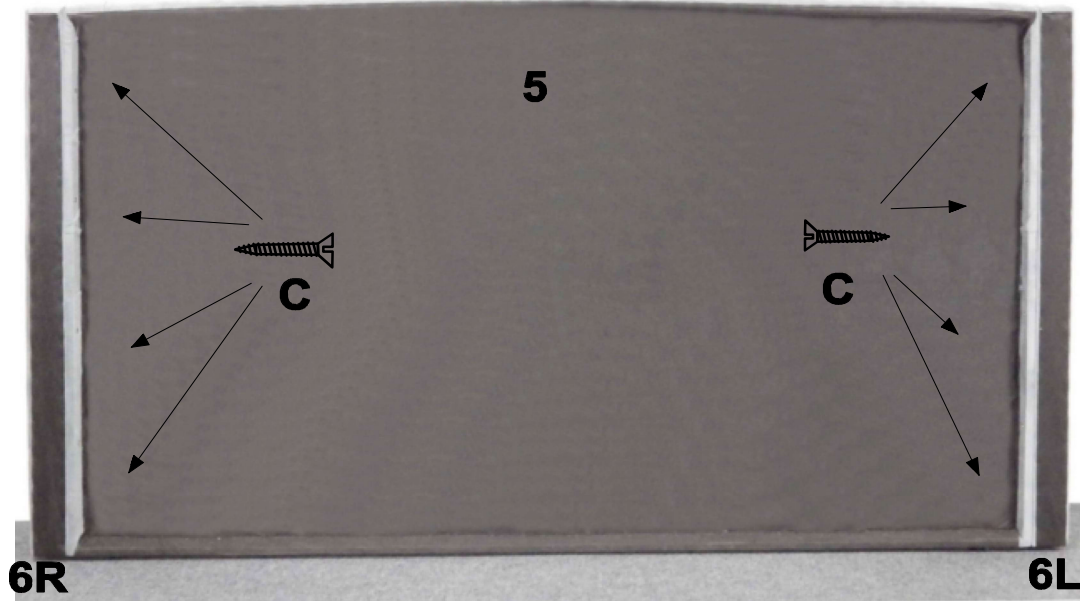

9.

