

MWST03

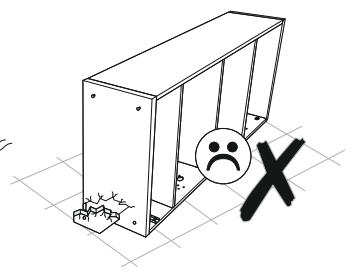

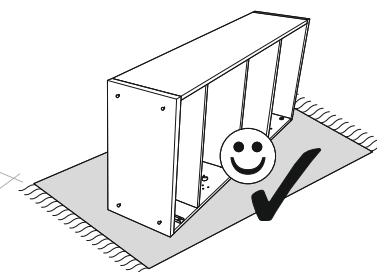

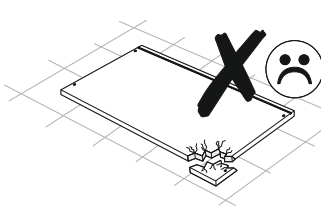

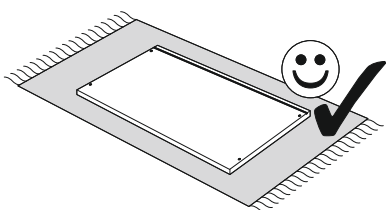
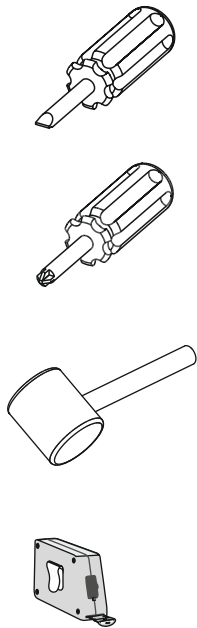
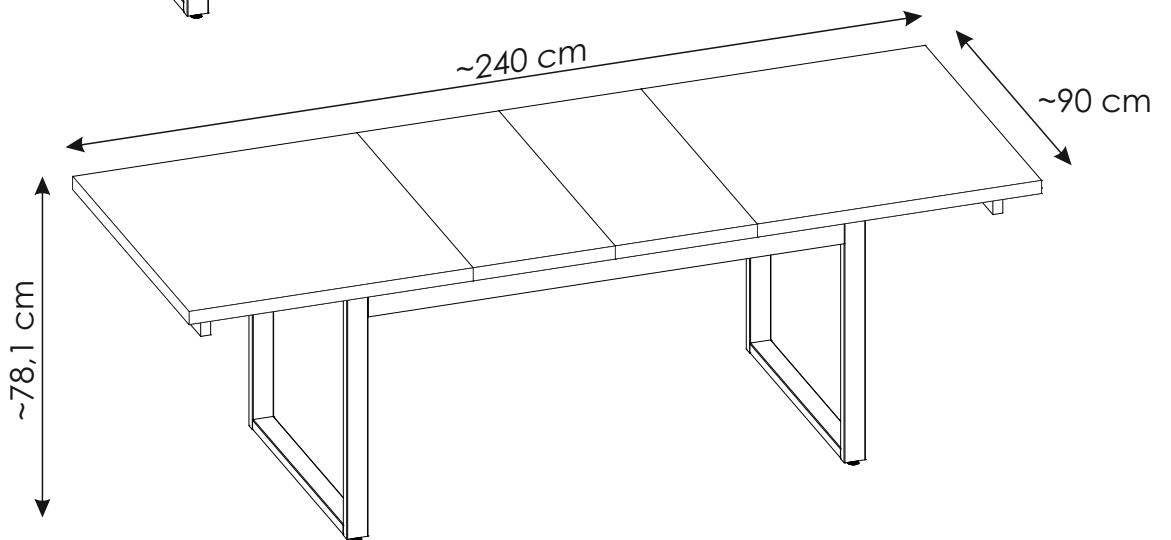
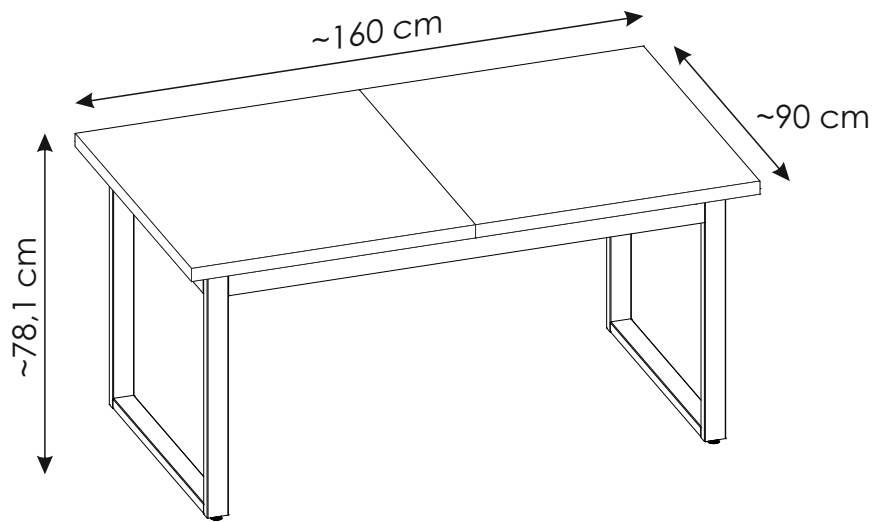
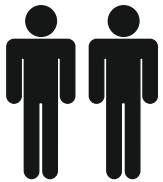
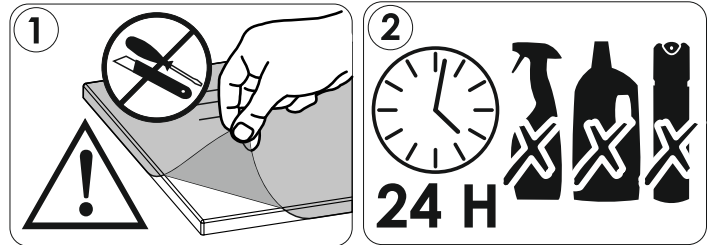
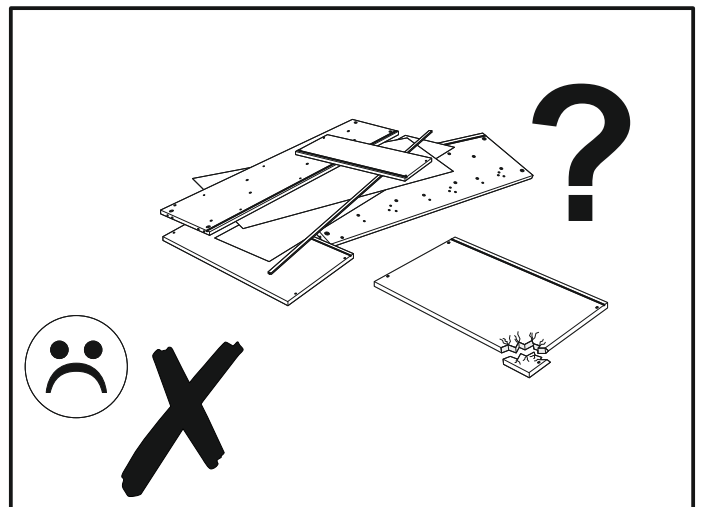
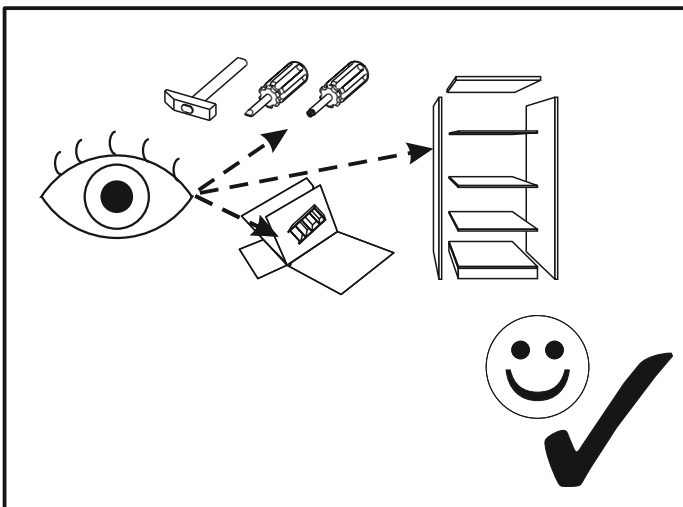
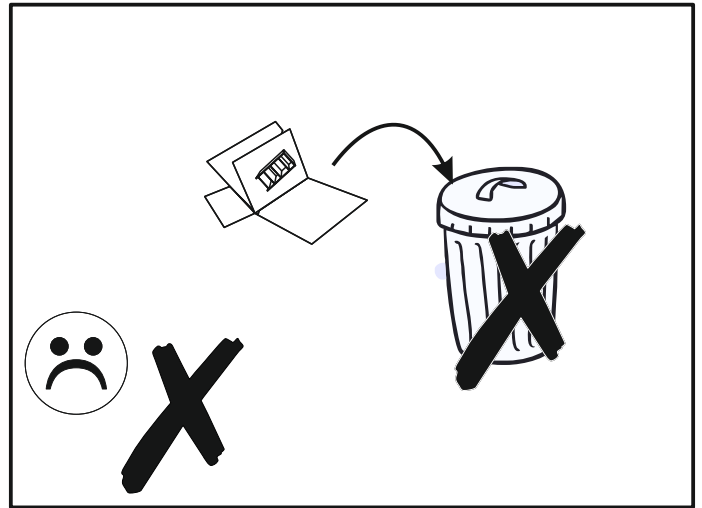
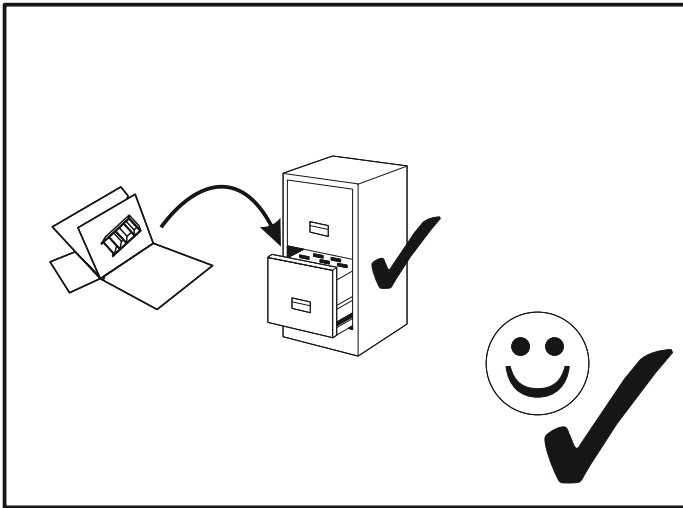
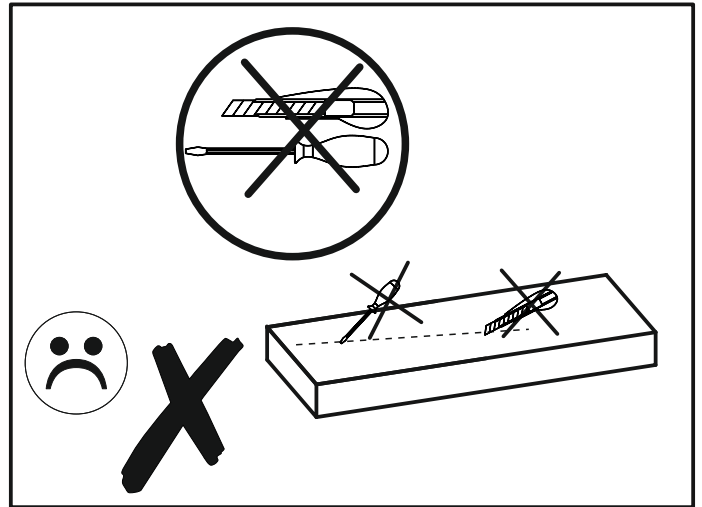
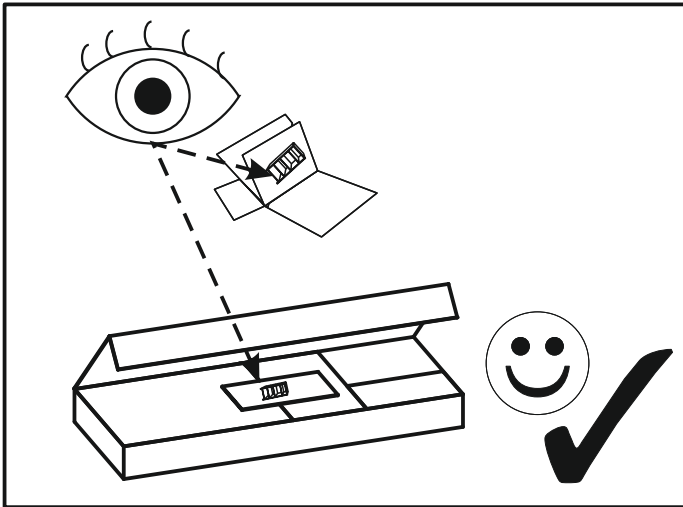

60 min

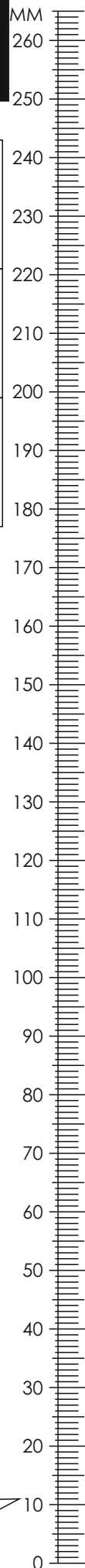

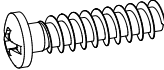
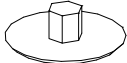

MWST03

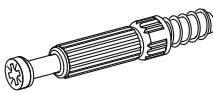
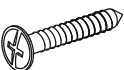
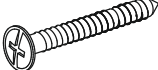

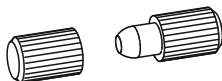
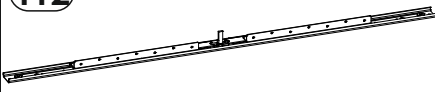
A0 8 x 24 mm x8 	A1 8 x 35 mm x16 	C9 6.3 x 24 mm x16 
E0 Ø16 x10 	E1 15 x 12 mm x10 	F1 6 x 34 mm x10 
I12 4 x 30 mm x40 	I14 4 x 40 mm x8 	O2A Ø20 x12 
R8 x12 	T12 L - 1270 mm x2 	

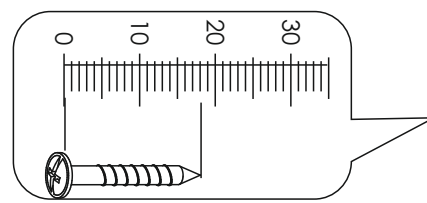
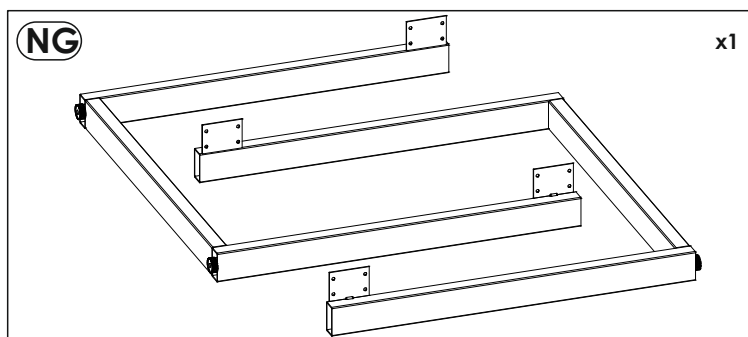

MWST03

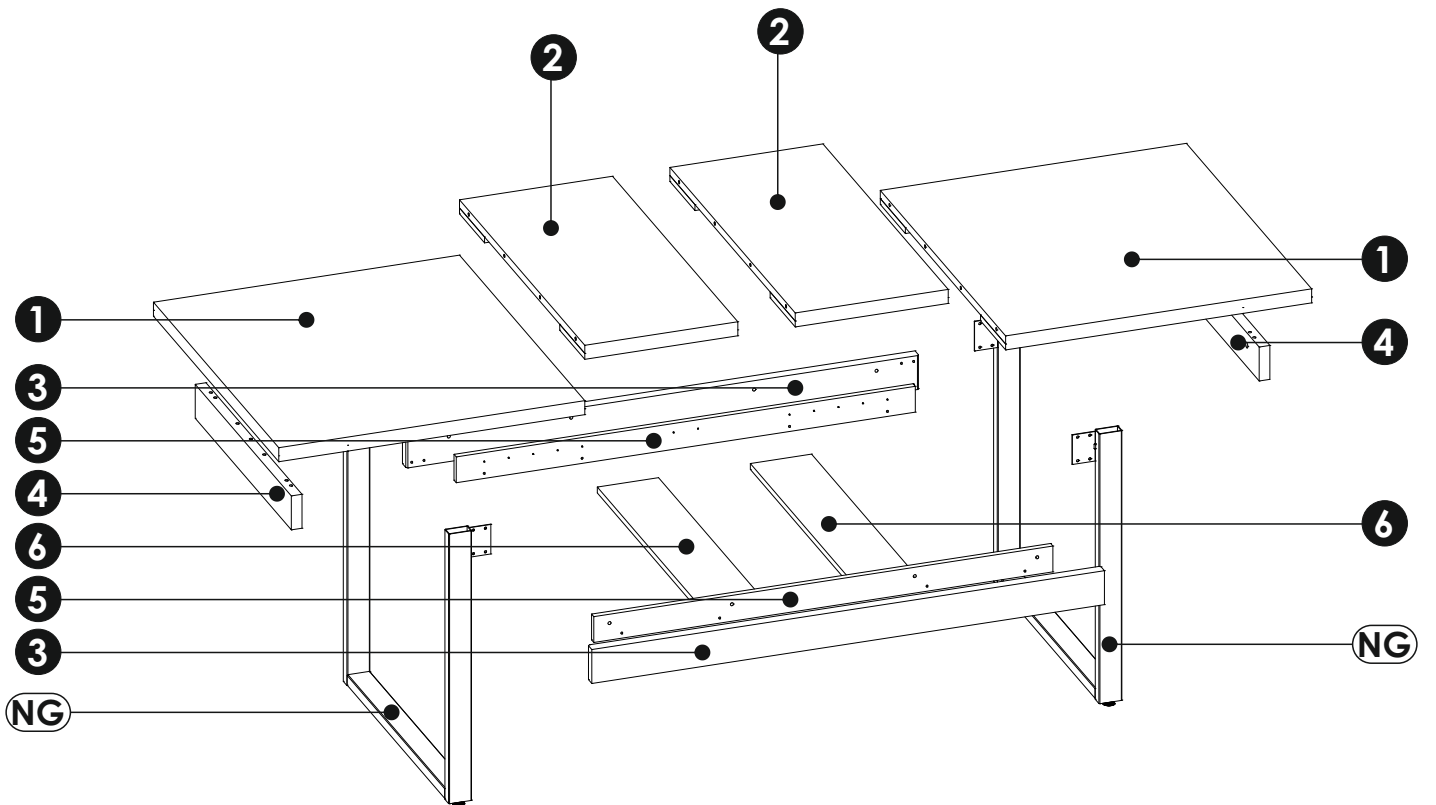
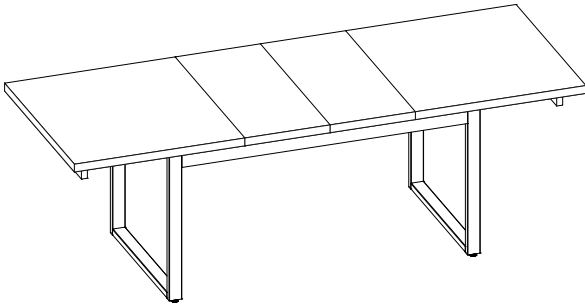

1	900	800	38	x2	2/4
2	900	400	38	x2	3/4
3	1340	92	28	x2	1/4
4	690	92	28	x2	1/4
5	1200	70	16	x2	1/4
6	704	160	16	x2	1/4
NG	741	760	120	x2	4/4

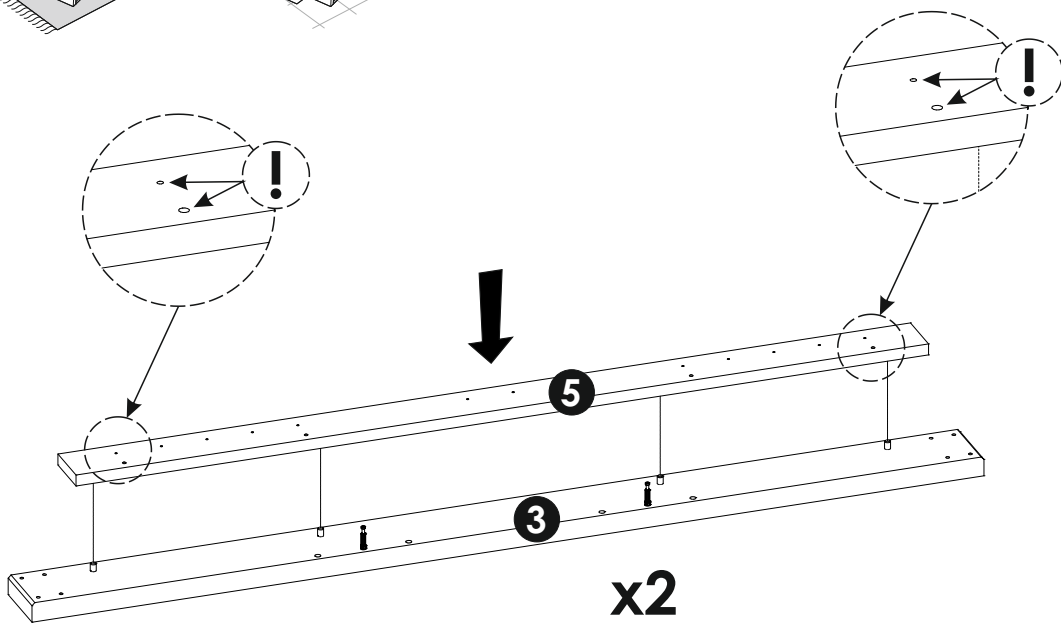
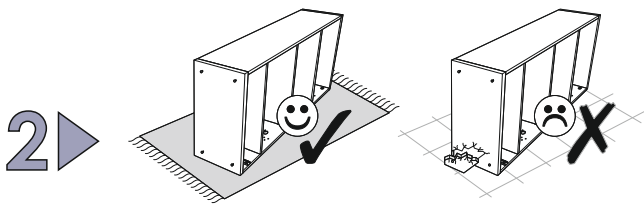
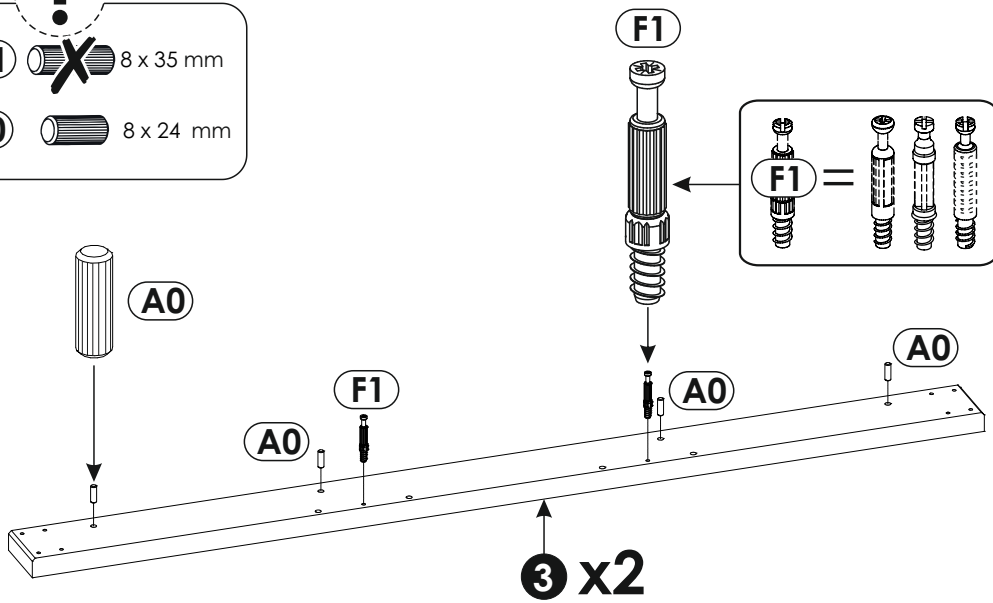
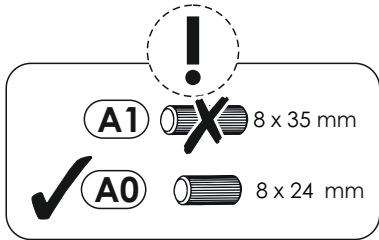
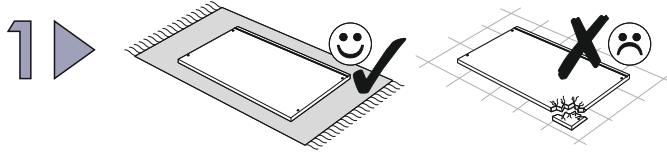
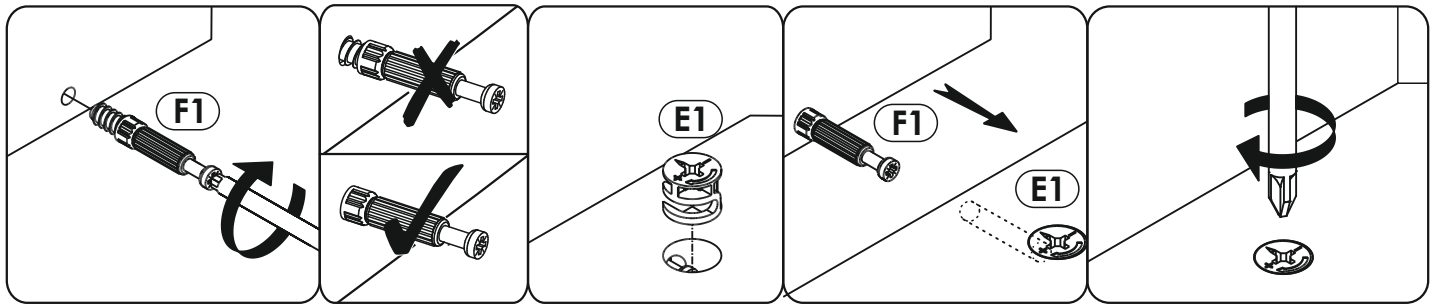

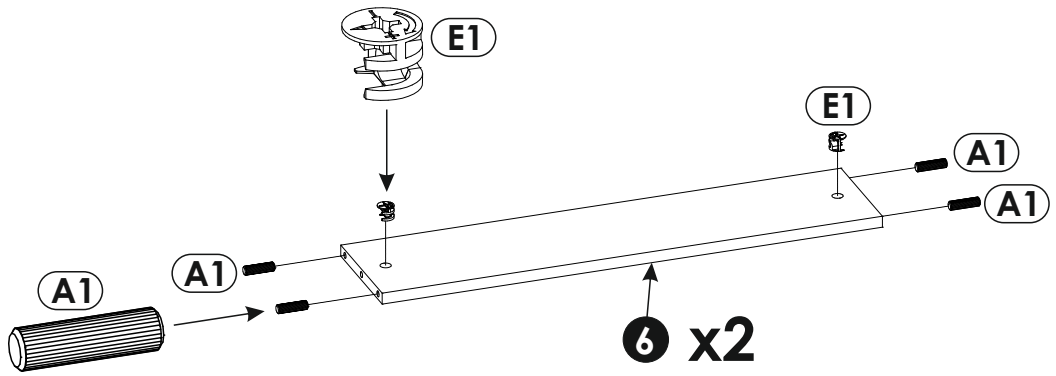
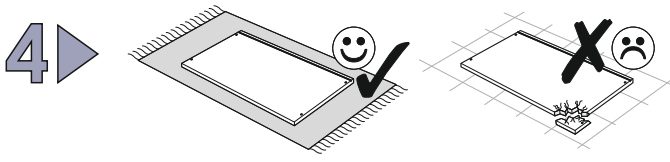
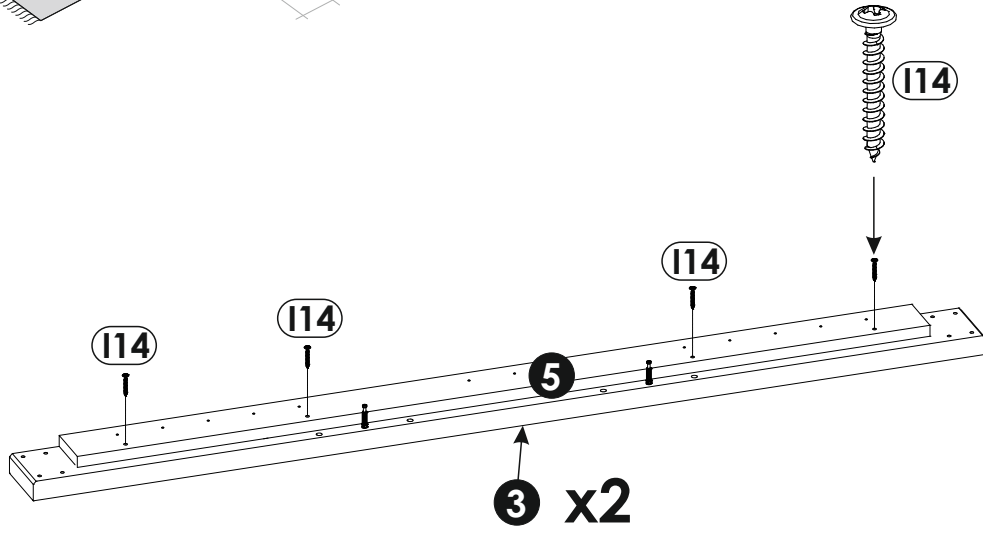
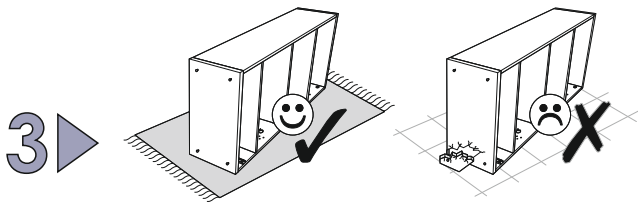

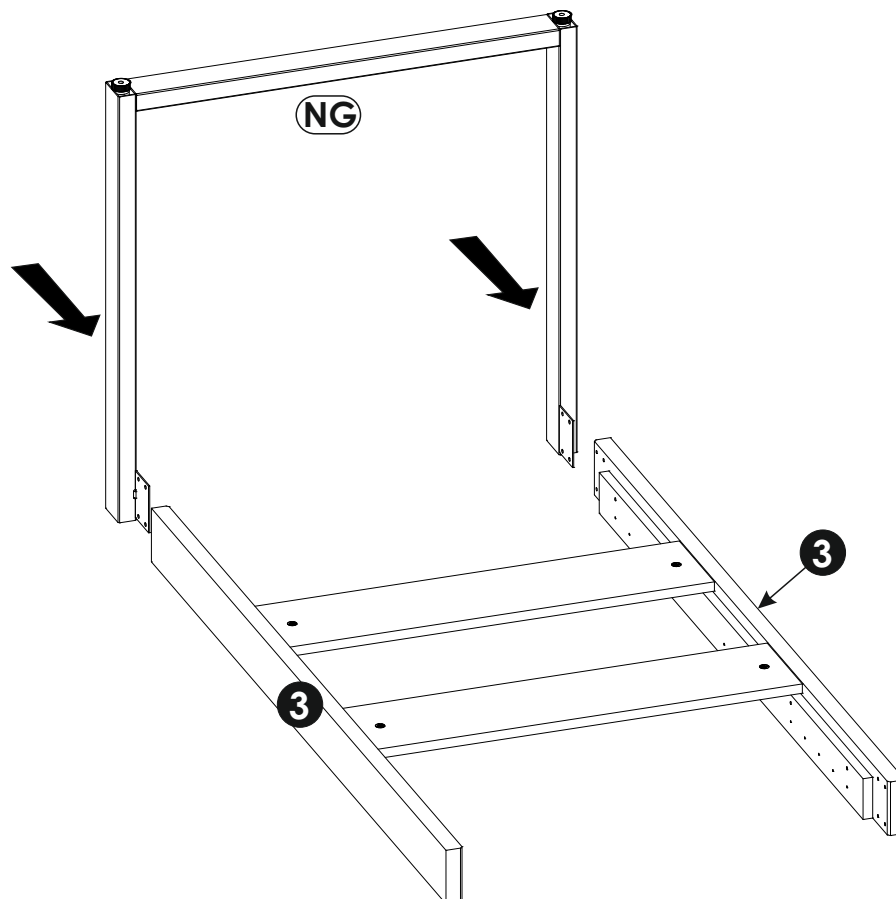
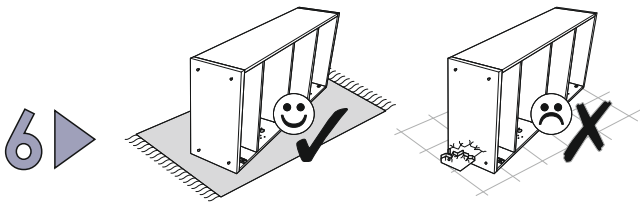
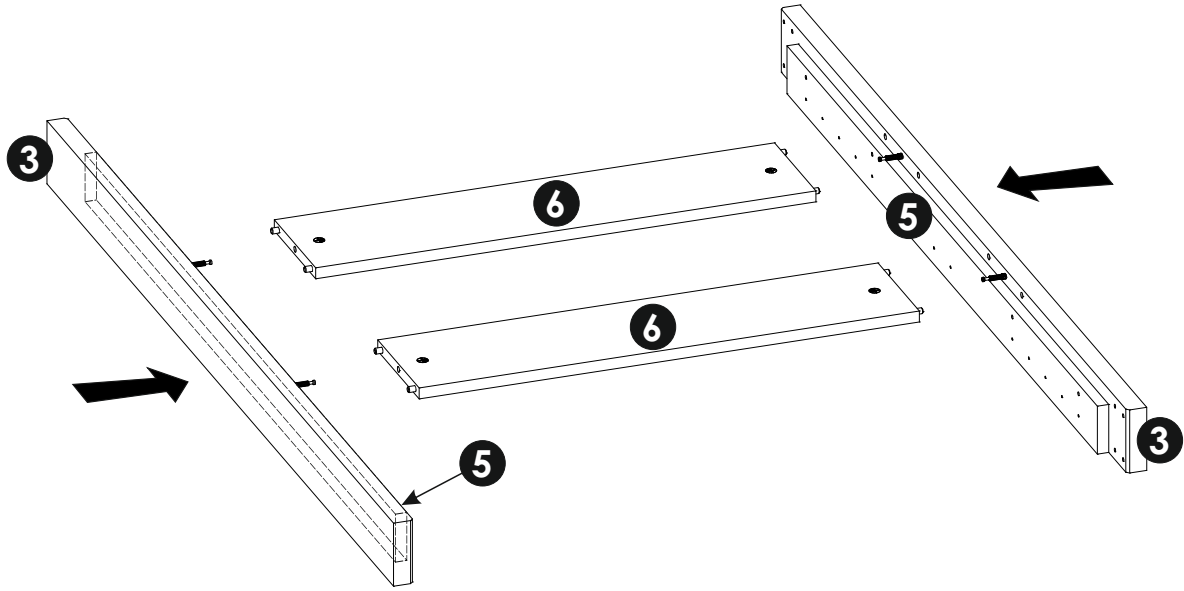
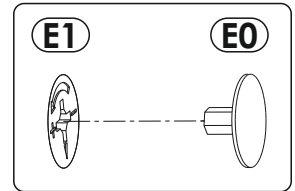
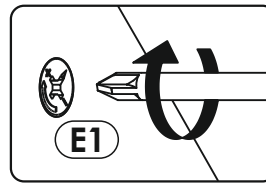
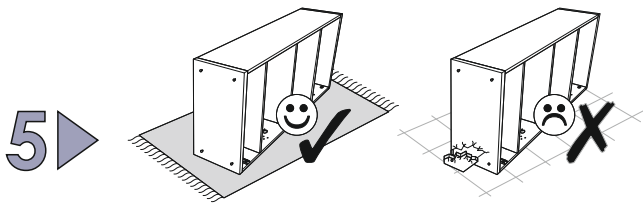

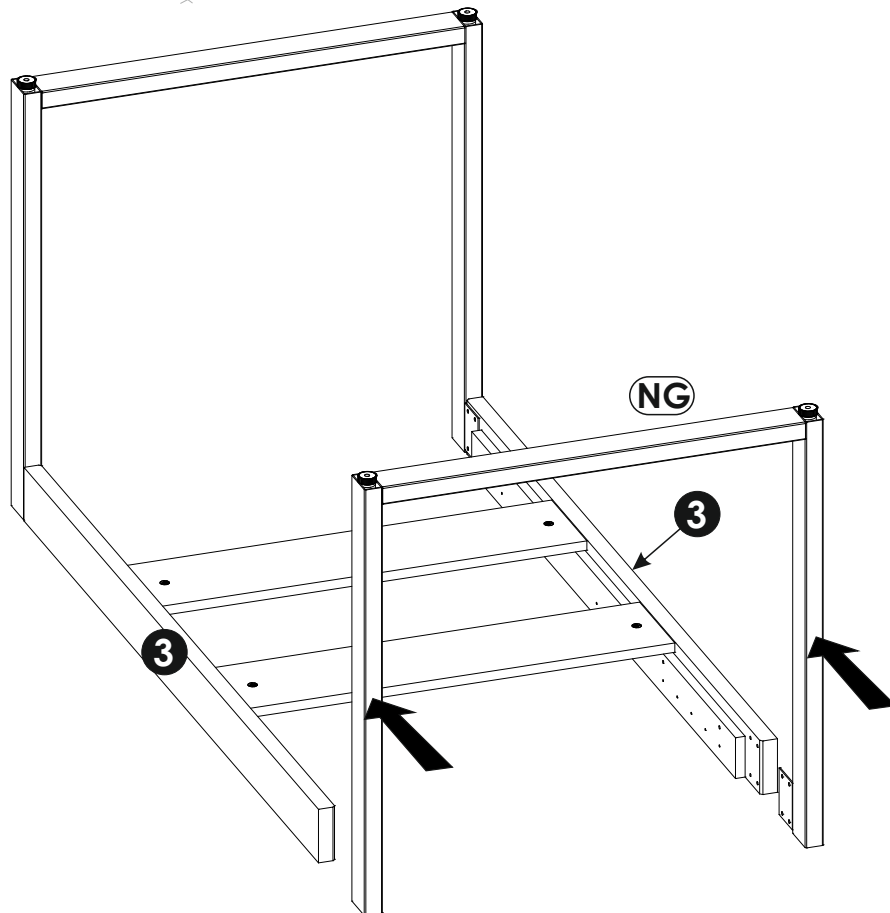
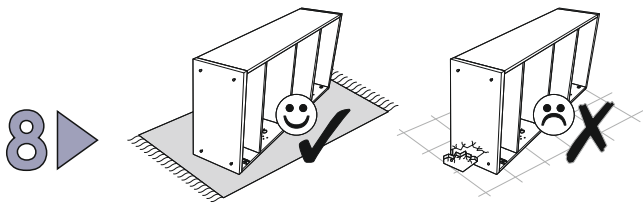
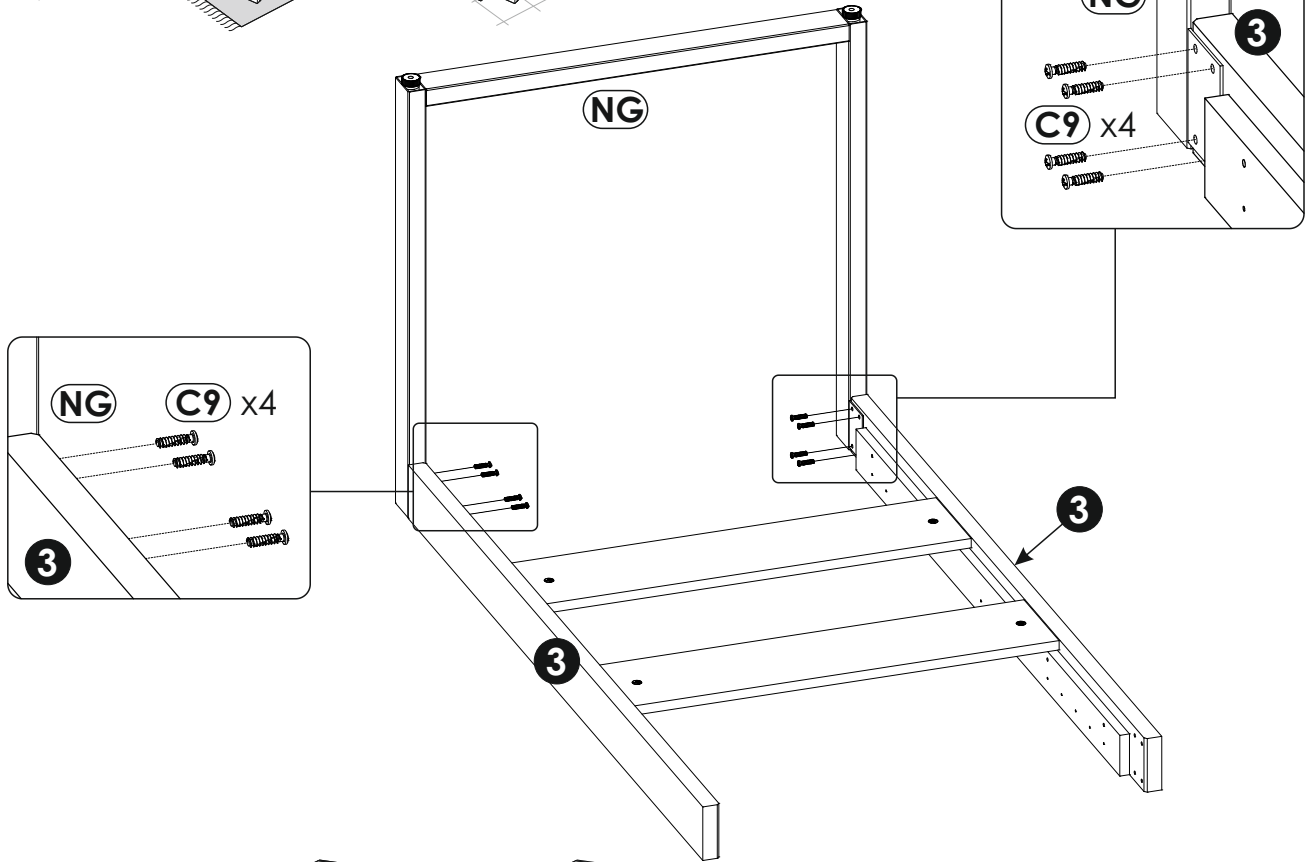
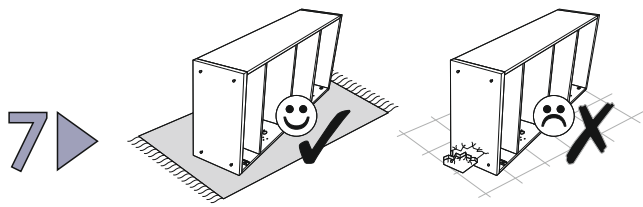

9 ▶

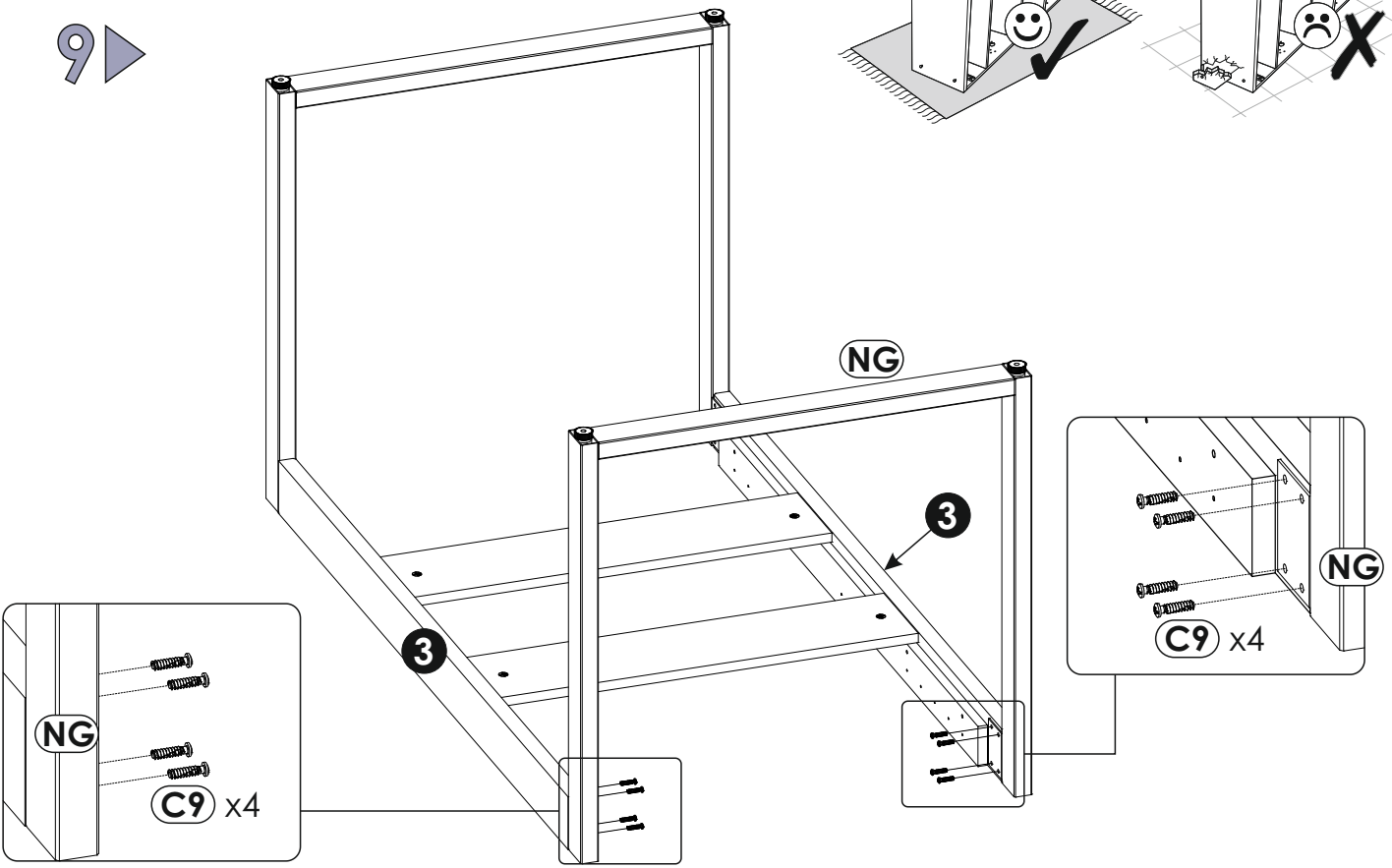
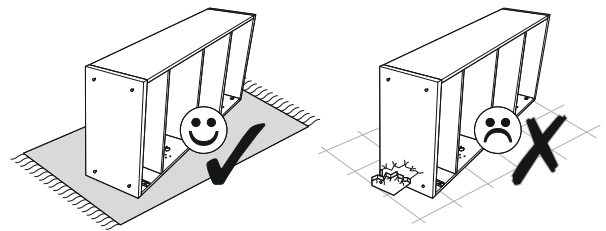

10 ▶

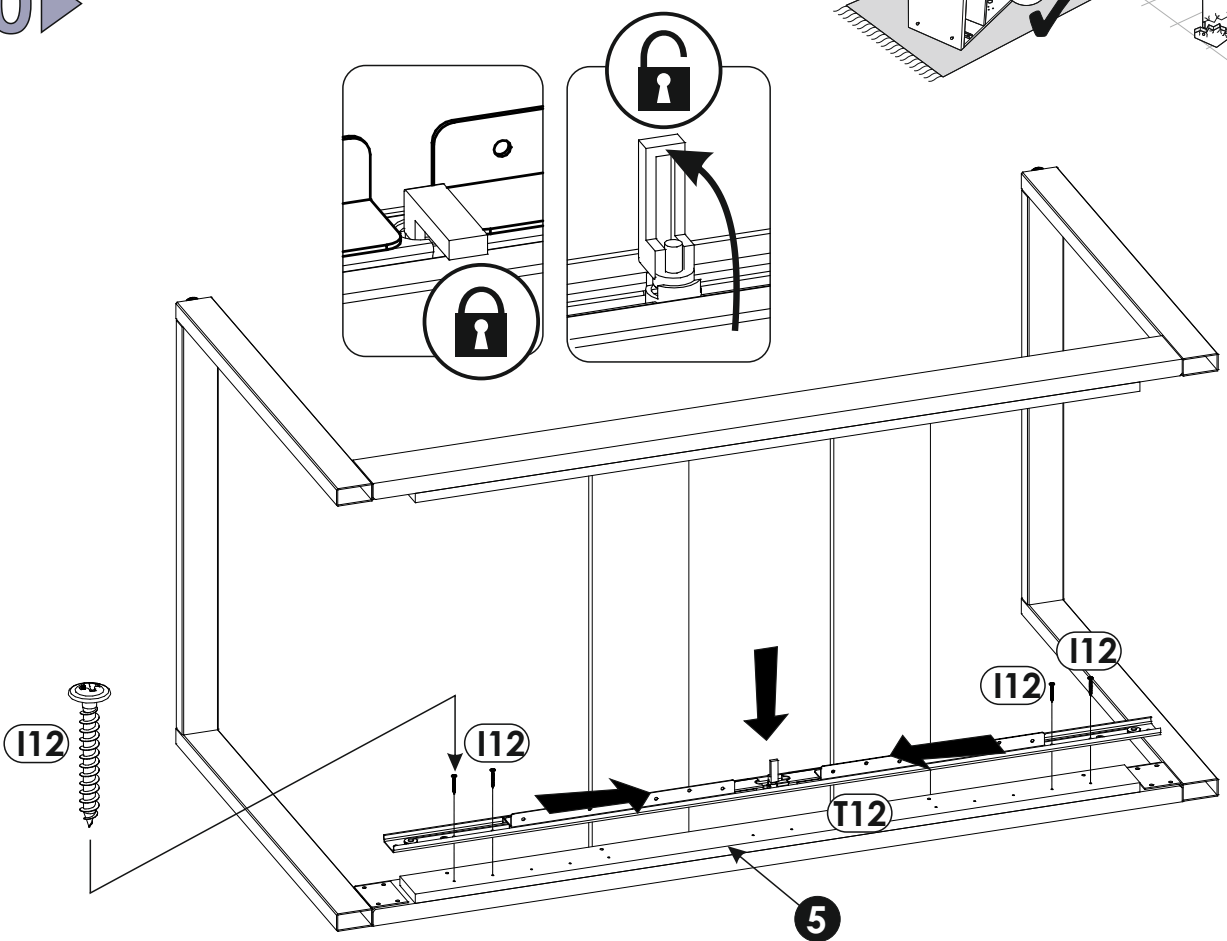
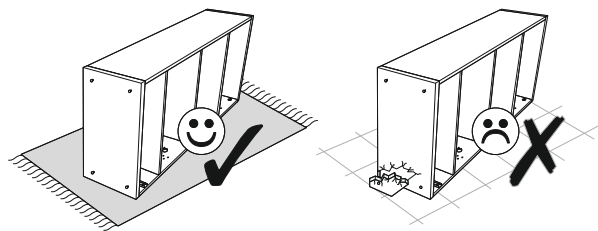

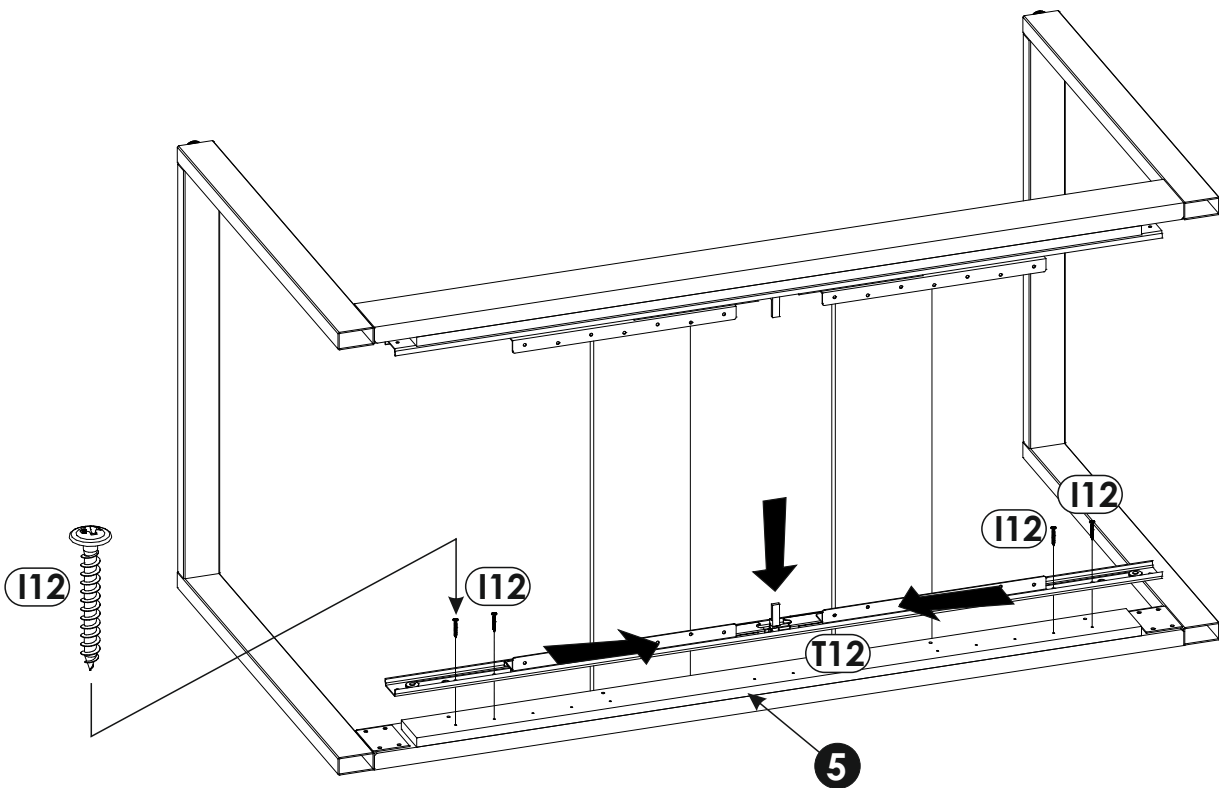
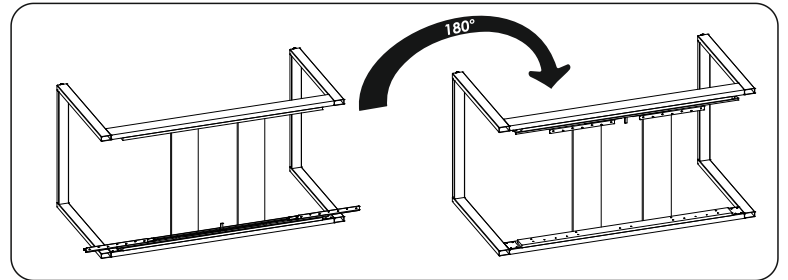
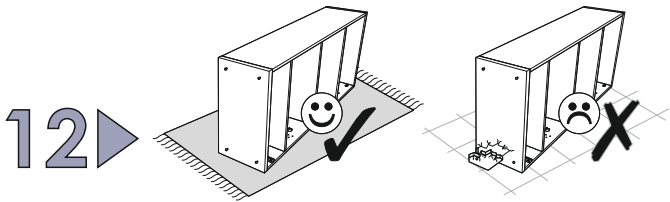
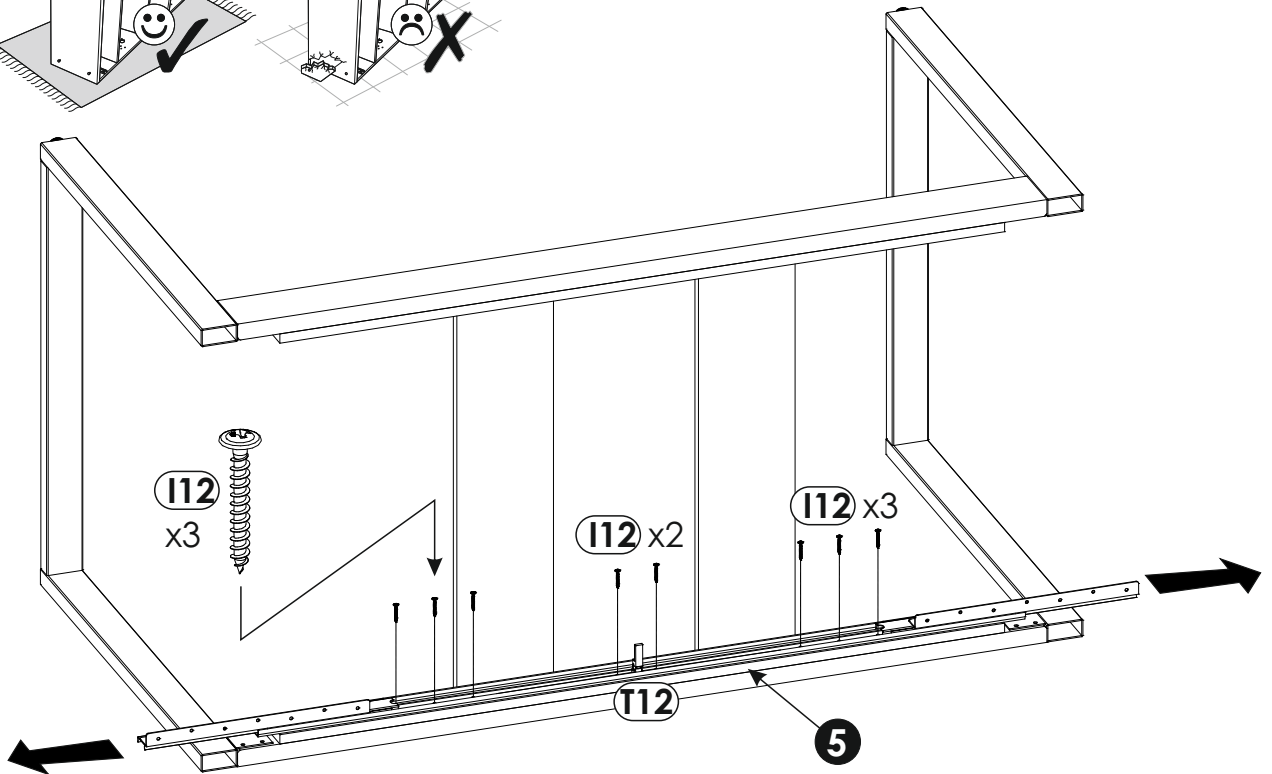
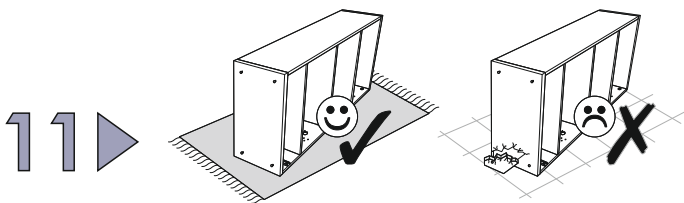

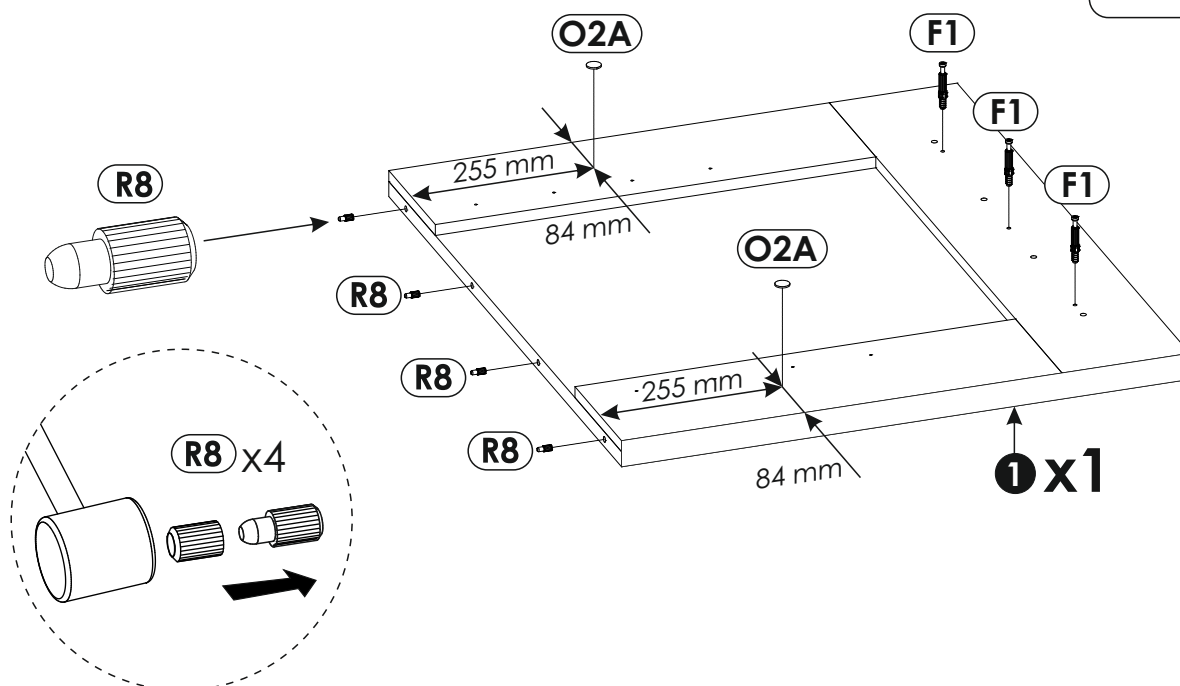
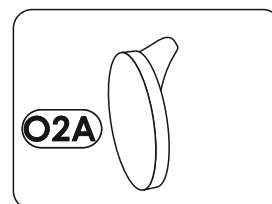
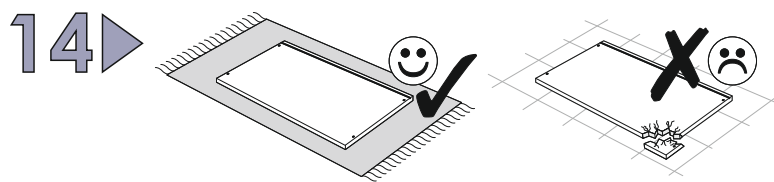
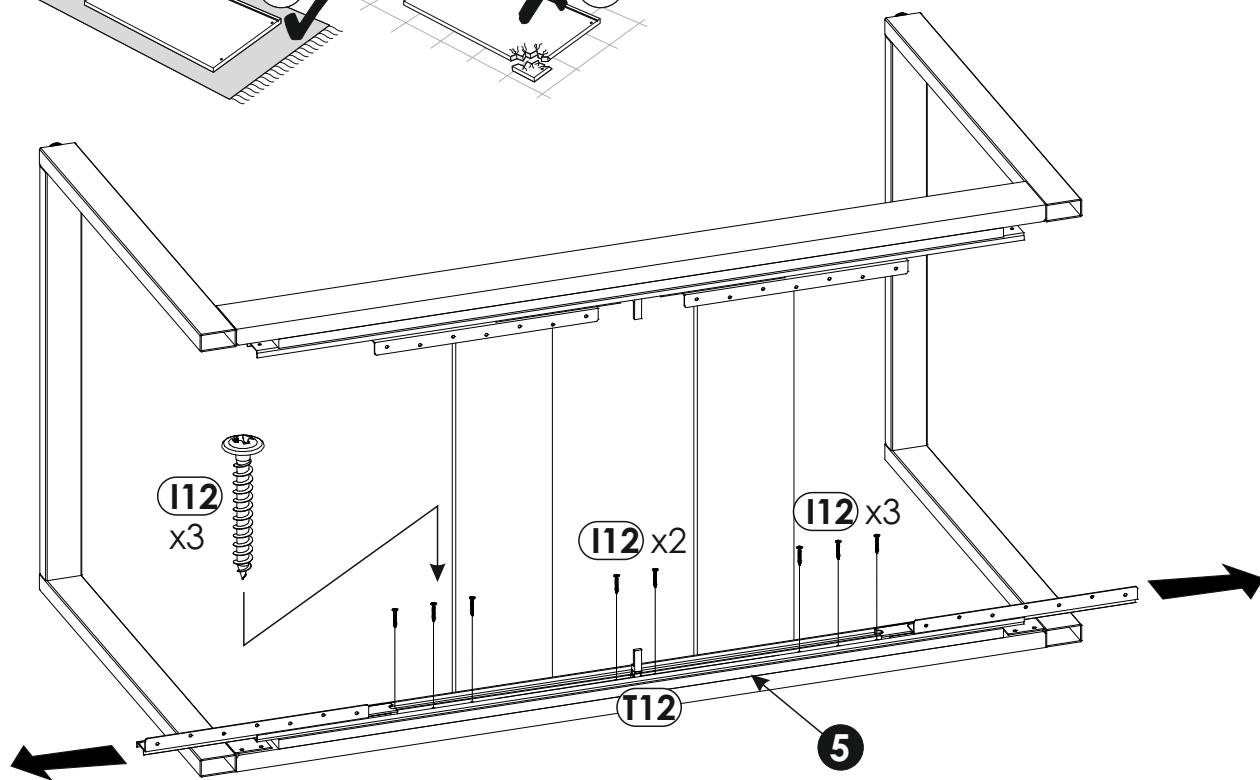
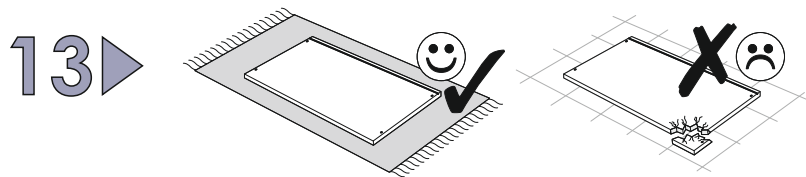

15 ▶

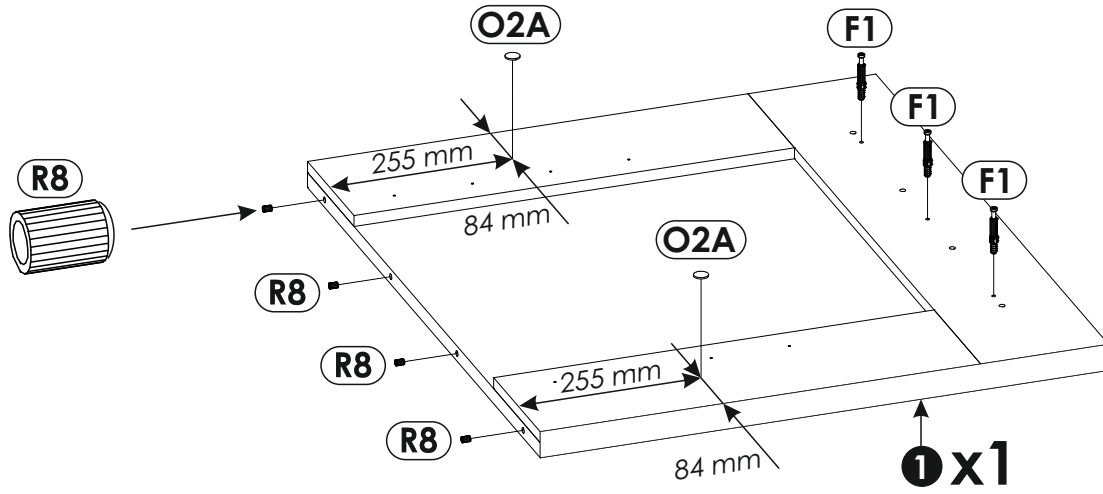
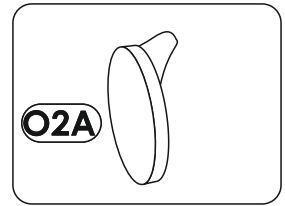
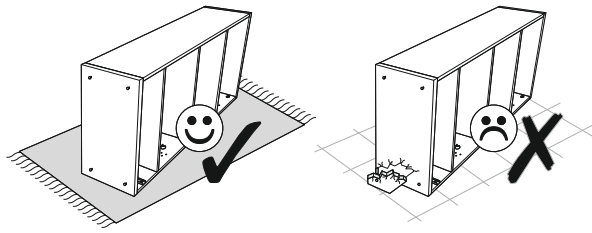

16 ▶

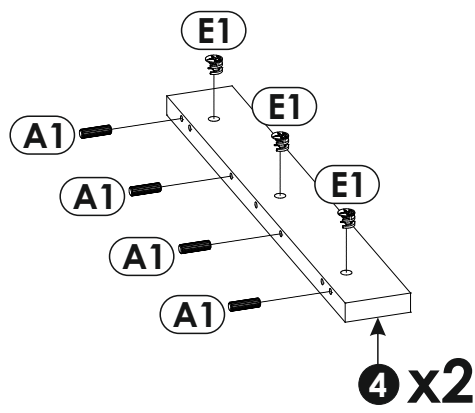
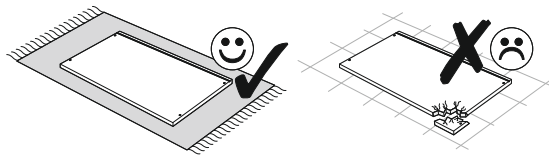

17▶

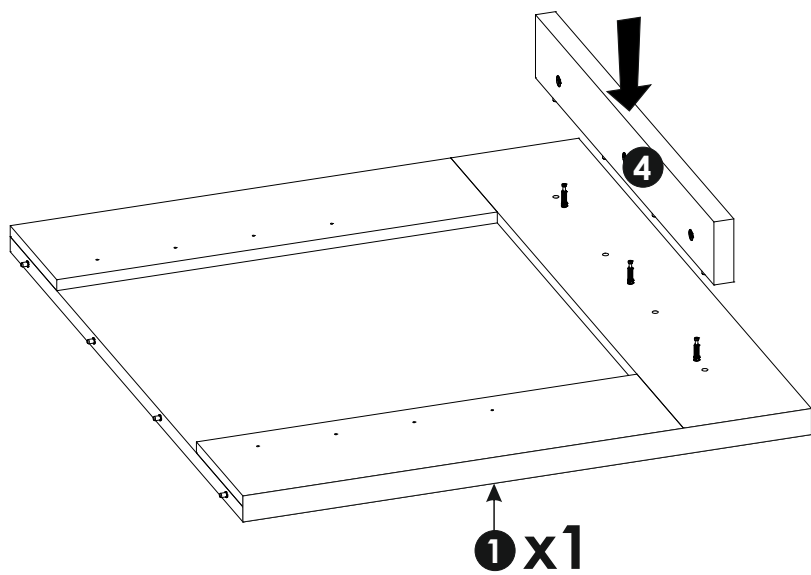
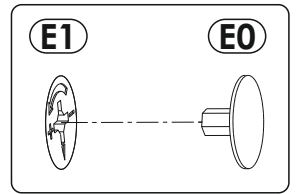
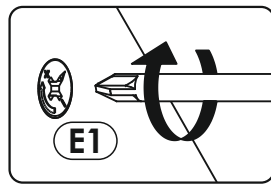
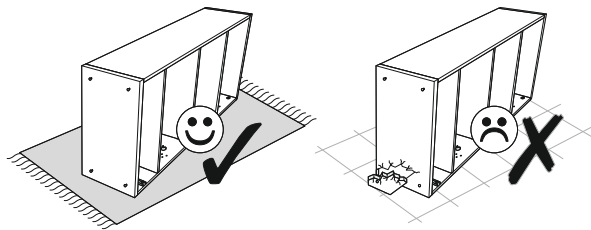

18▶

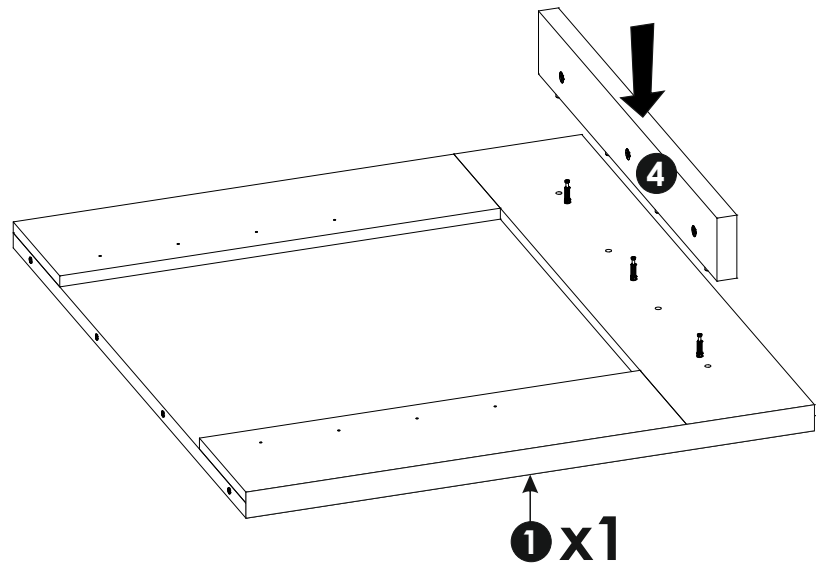
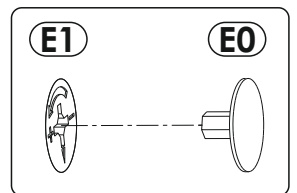
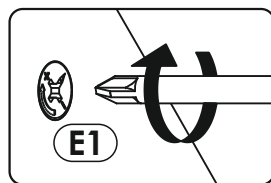
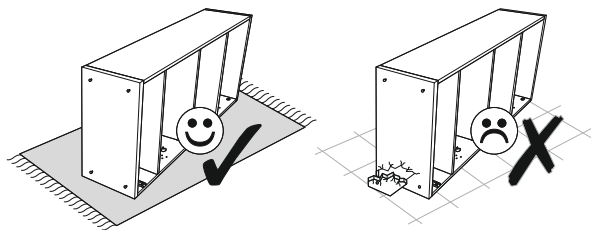

19▶

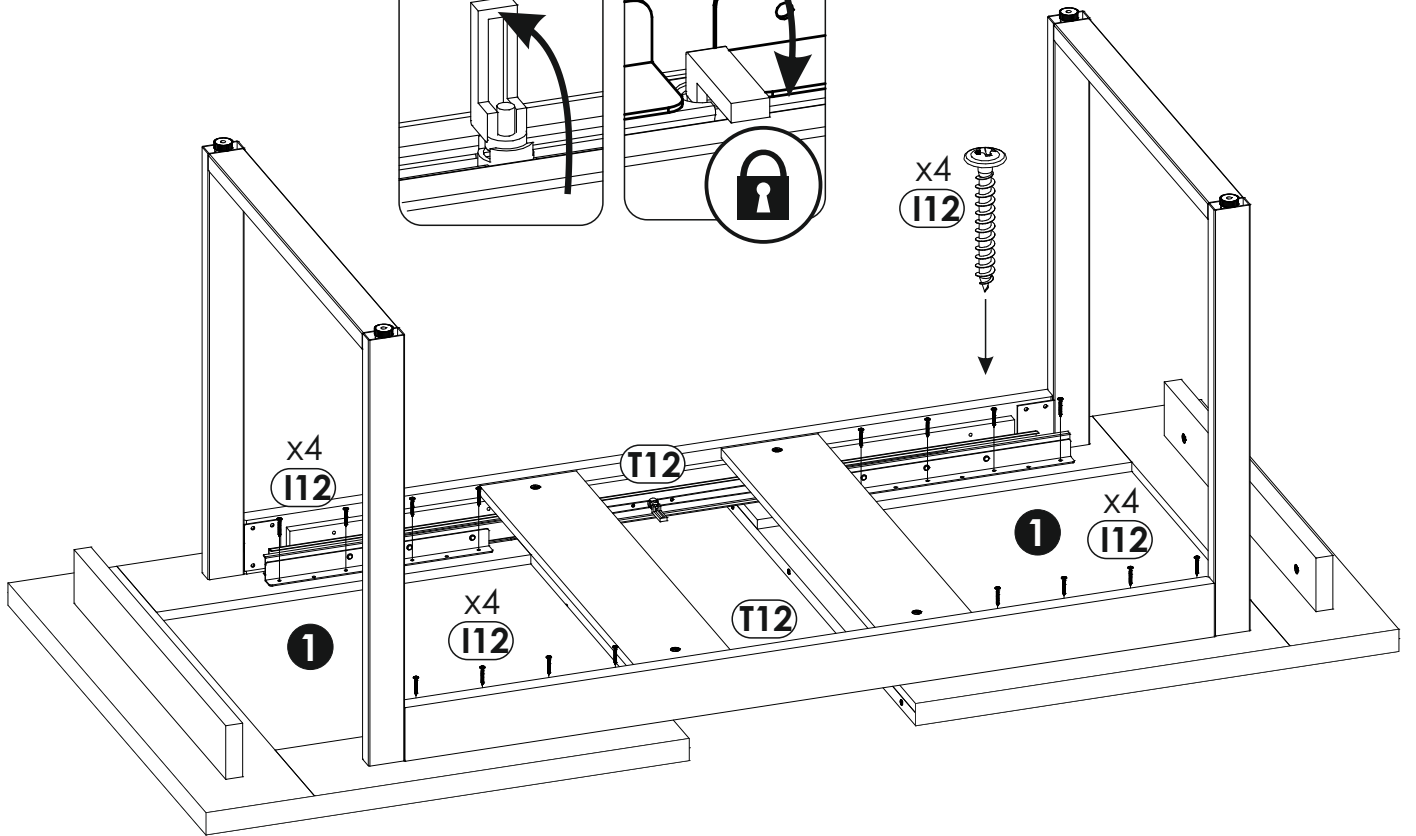
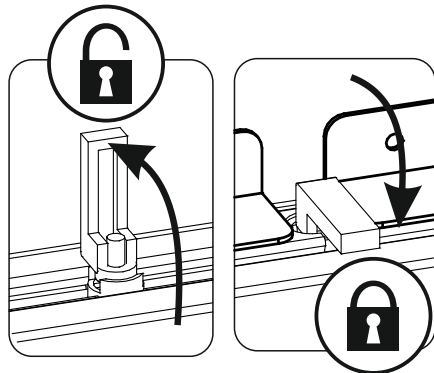
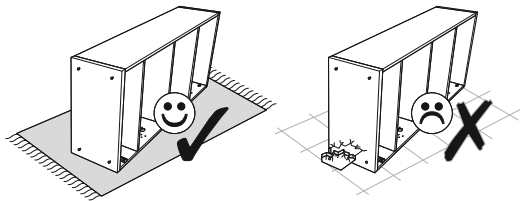

20▶

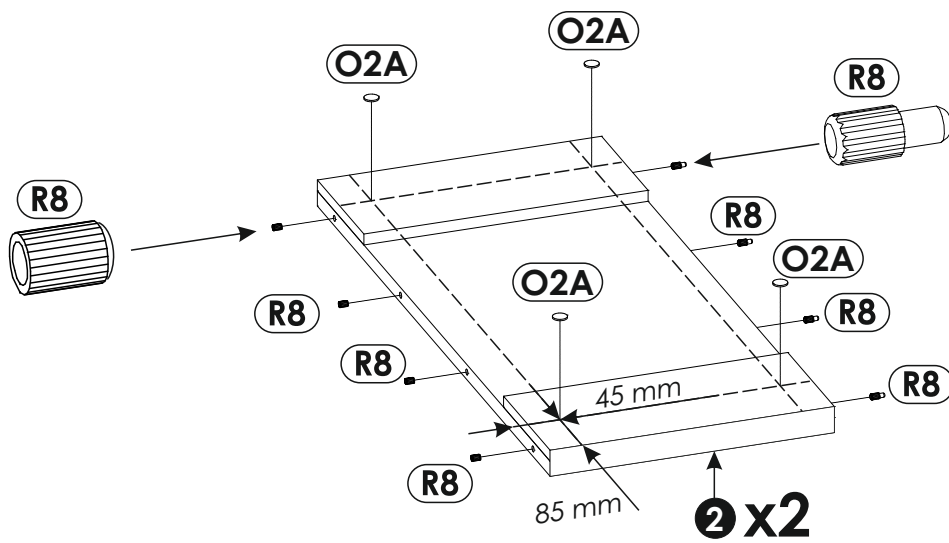
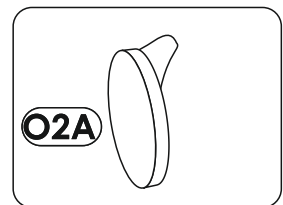
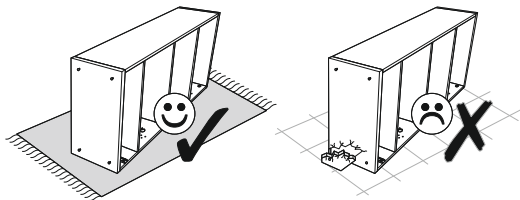

21 ▶

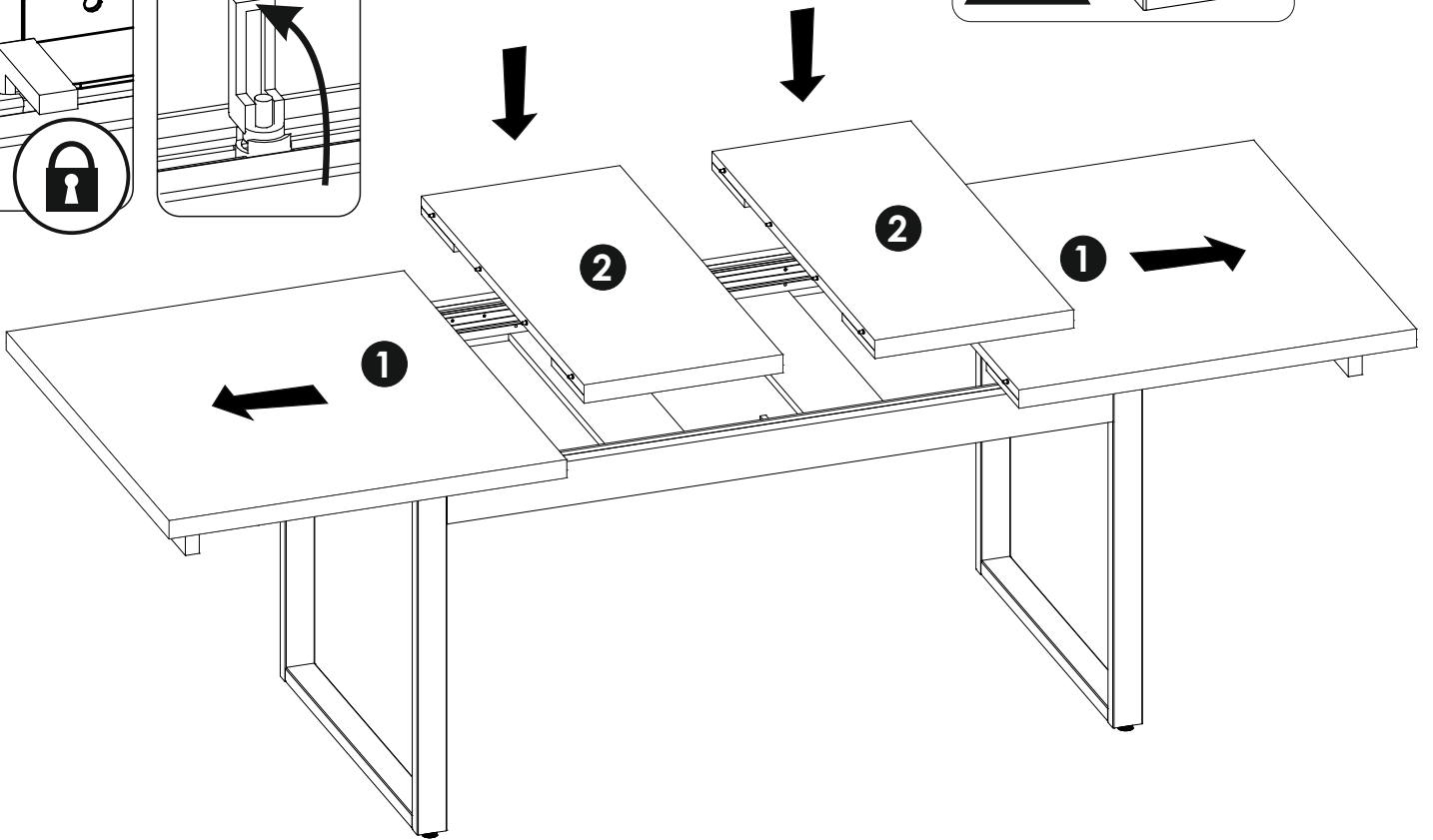
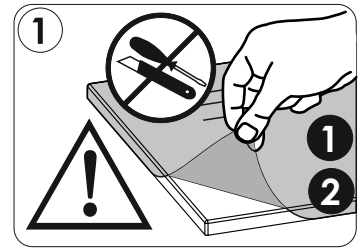
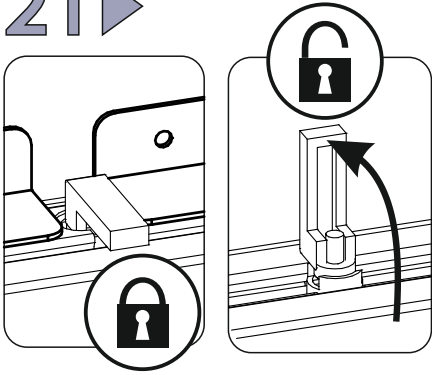

22 ▶

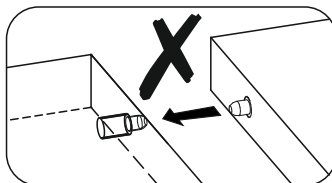
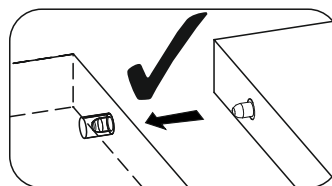
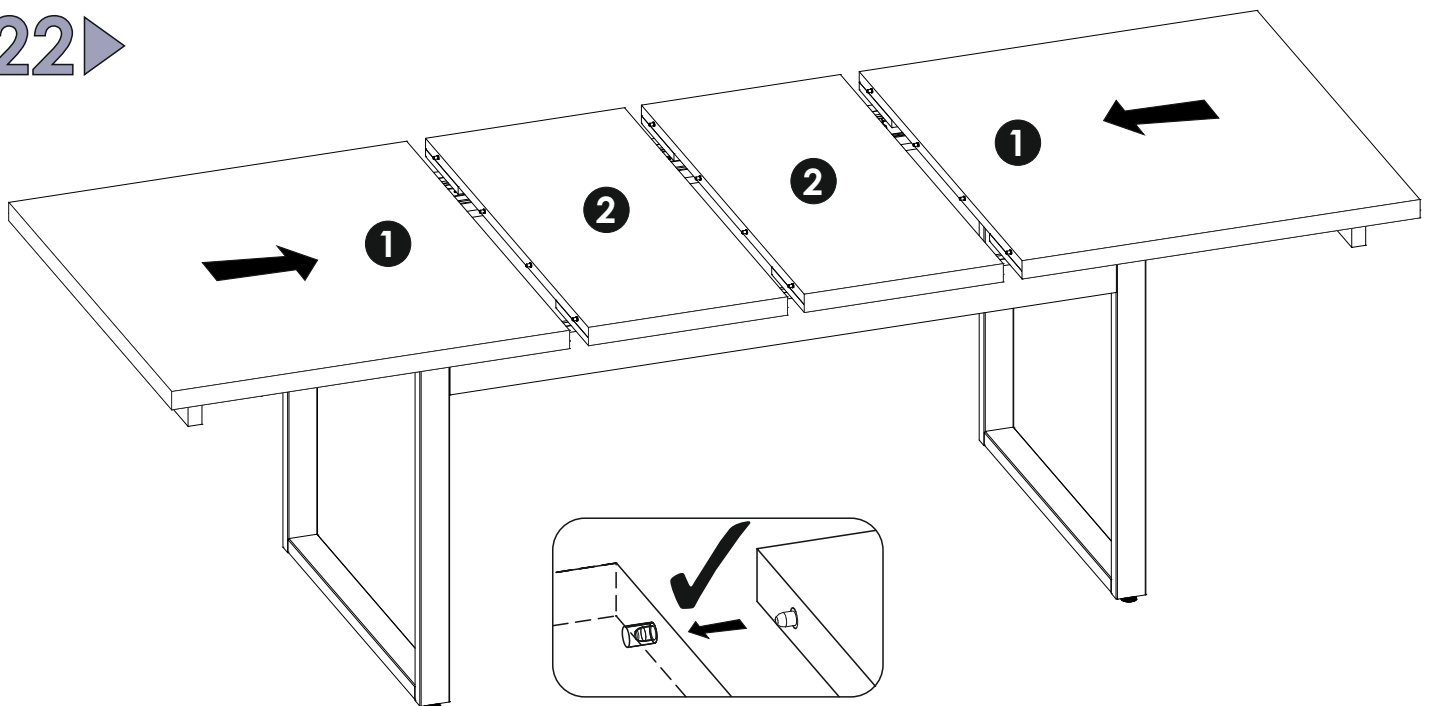

23 ▶

