

Mirjam

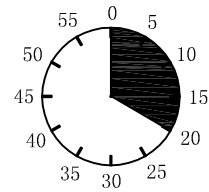
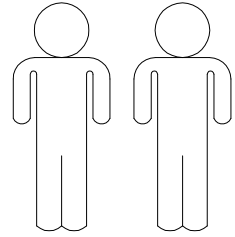
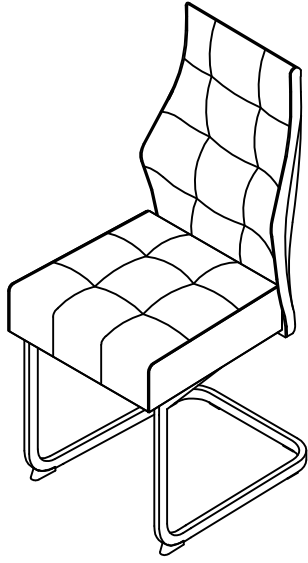

1

2

3

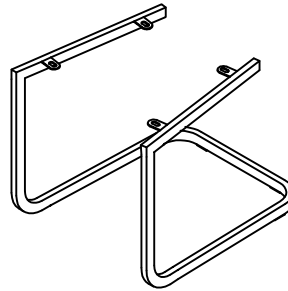
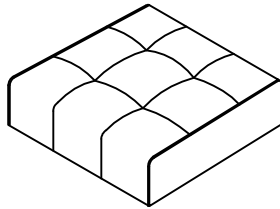
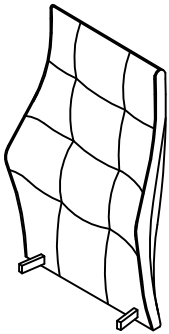

1	1X
2	1X
3	1X

A

M6*12

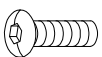

4X

B

M6*18

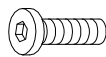

4X

C

Ø18*Ø6.5*1.5



4X

D

M4*20

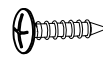

4X

E



2X

F

4mm

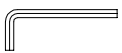

1X

I.

1.

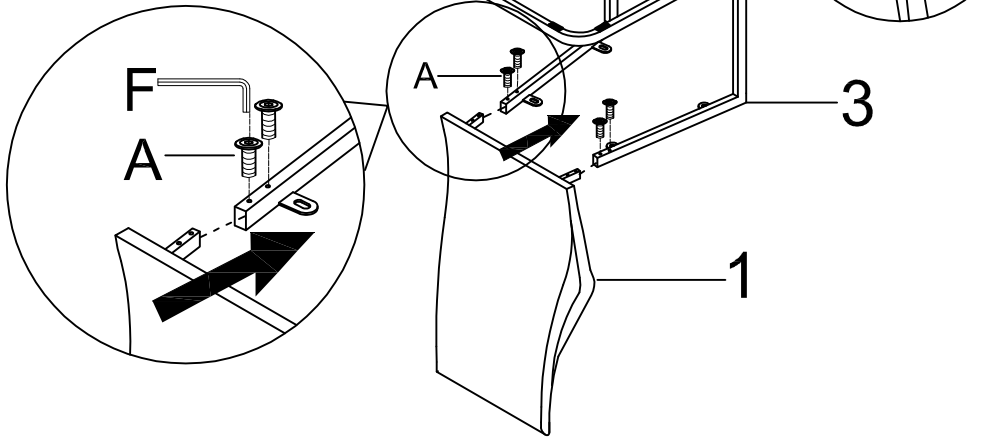

A
M6*12
4X

D
M4*20
4X

E
2X

F
4mm
1X

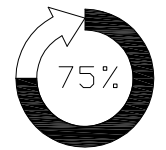

2.

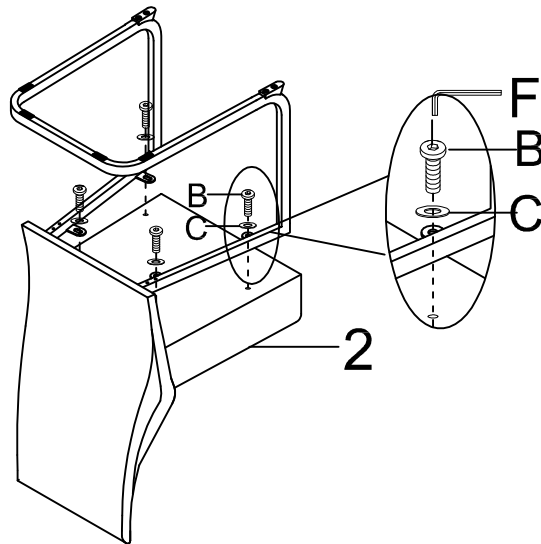

B
M6*18
4X

C
Ø18*Ø6.5*1.5
4X

F
4mm
1X

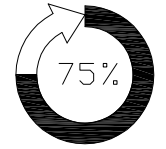

3.

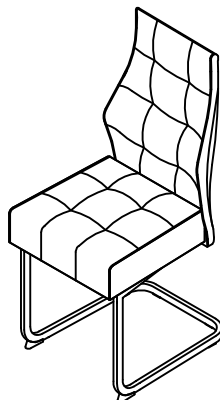

F
4mm
1X

