

# Sonja

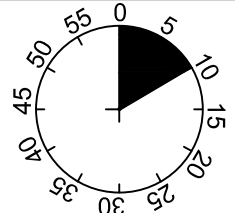

1

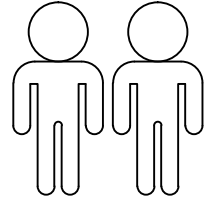
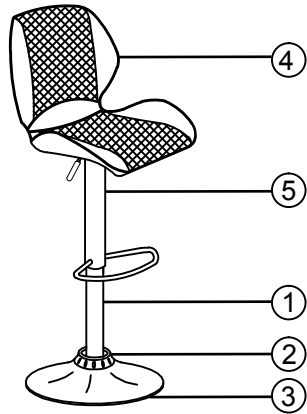

2



3



4

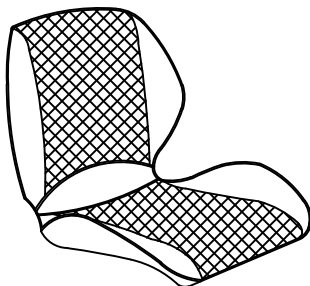

5

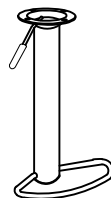

1	1x
2	1x
3	1x
4	1x
5	1x

A

M6X20



2x

B

M6x30



2x

C

Ø18xØ6x1.5



4x

D

Ø18xØ8x10



2x

E

4MM



1x

I.



1

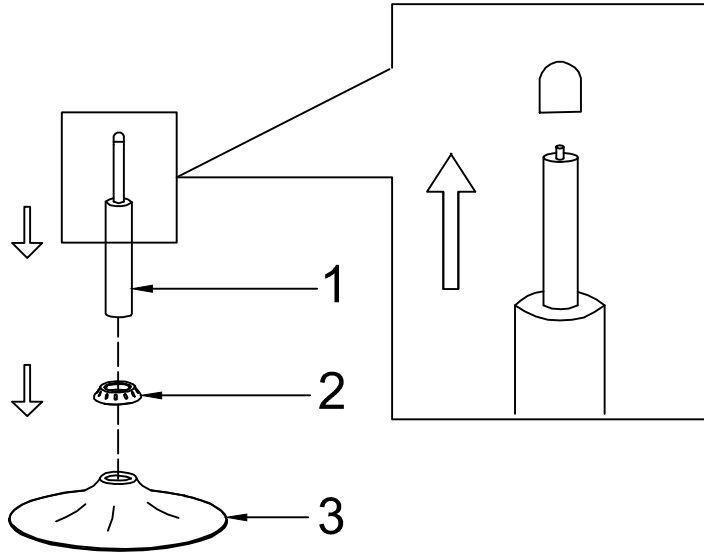

2

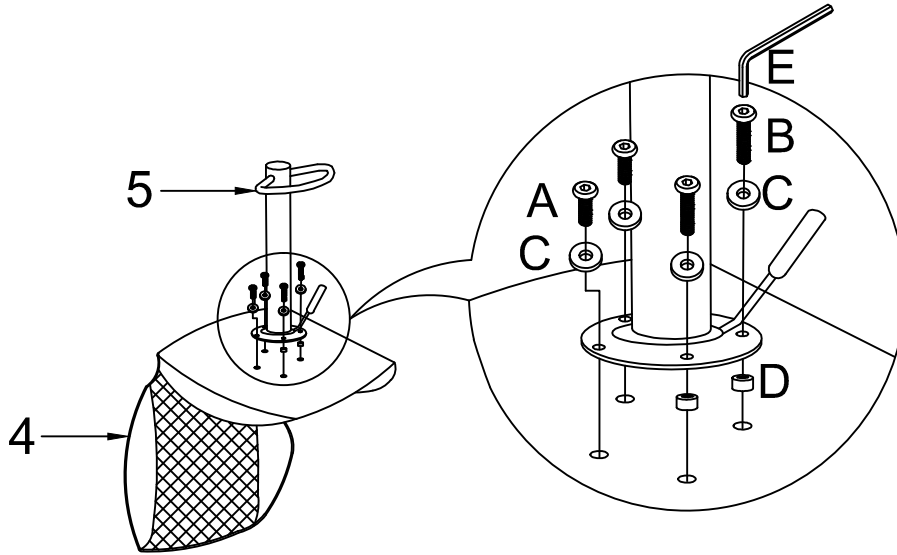

A	M6x20
	2x
B	M6x30
	2x
C	Ø18xØ6x1.5
	4x
D	Ø18xØ8x10
	2x
E	4MM
	1x



3

